

**MYScope**  
MICROSCOPY TRAINING

# Cryo-Electron Microscopy

# Train for advanced research

## Welcome

MyScope was developed by Microscopy Australia to provide an online learning environment for those who want to learn about microscopy. The platform provides insights into the fundamental science behind different microscopes, explores what can and cannot be measured by different systems and provides a realistic operating experience on high end microscopes.

We sincerely hope you find our website: [www.myscope.training](http://www.myscope.training) an enjoyable environment. In there you can explore the microscopy space and leave ready to undertake your own exciting experiments.

### Attribution-Share Alike

Unless otherwise noted, content on this site is licensed under the Creative Commons Attribution-ShareAlike 4.0 International License.

We cannot revoke these freedoms as long as you follow the license terms.



## Module Contents

### What is Cryo-EM?

- Introduction to cryo techniques
- Why cryo?
- Which cryo technique to use
- Challenges of cryo

### Principles of freezing

- Properties of water

### Freezing of water

#### Types of freezing

- Plunge freezing
- High pressure freezing
- Other freezing techniques

### Cryo-TEM

- Introducing cryo-TEM
- The cryo TEM

- The microscope
- Electron energy Filters
- Phase plates
- Electron detectors

#### Imaging in a cryo-TEM

- How images are formed
- Fourier Transformation
  - Why do Fourier transforms
  - What is a Fourier Transform?
  - Fourier transforms in cryo-TEM image processing
  - The power spectrum
  - Why do we even need to look at the power spectrum?
- Contrast transfer function

#### Single particle analysis

- Introducing Single Particle Analysis
- Biochemical preparation and stabilisation
- Specimen screening by negative staining
- Vitrification
- Optimisation of orientation and distribution Specimen screening by cryo
- Data acquisition
- Motion correction
- Dose weighting
- Averaging
- Particle picking
- 2D classification
- 3D reconstruction
- Validation
- Sub-tomogram averaging

#### Cryo-tomography (cryo-ET)

- Introducing cryo-electron tomography
- The TEM for cryo-ET
- Phase plates
- Sample preparation
- Data acquisition
- Tomogram reconstruction
- Tomogram interpretation

## Subtomogram averaging

- Introducing sub-tomogram averaging
- Particle picking
- Sub-tomogram averaging and alignment
- Sub-tomogram classification
- Model refinement and validation

## Electron crystallography

- Diffraction-based Cryo-EM Techniques
- 2D crystallography
- Introducing Micro-ED
- The sample for Micro-ED
- Sample preparation for Micro-ED
- The TEM for Micro-ED
- Sample screening for Micro-ED
- Data collection — Micro-ED
- Data analysis — Micro-ED

## **Cryo-SEM**

- Introducing cryo-SEM
- Cryo-SEM design
- Sample preparation – Freezing & cryo-transfer
- Sample preparation – Fracturing and cryo-planing
- Sample preparation – Sublimation
- Sample preparation – Coating
- Cryo-SEM operation
- Cryo-SEM microanalysis
- Cryo-SEM artefacts

## **Cryo-FIB**

- Introducing cryo-FIB
- TEM lamella production by cryo-FIB
- Cryo-FIB-SEM Volume Imaging

## **Cryo-ultramicrotomy**

## **Credits**

# What is Cryo-EM? – Introduction to cryo techniques

Cryo-electron microscopy or cryo-EM is the term used to describe electron microscopy of frozen samples. The aim is to look at structures in as near to native state as possible. It is particularly suited to wet samples and so has become a significant tool for studying biological specimens.

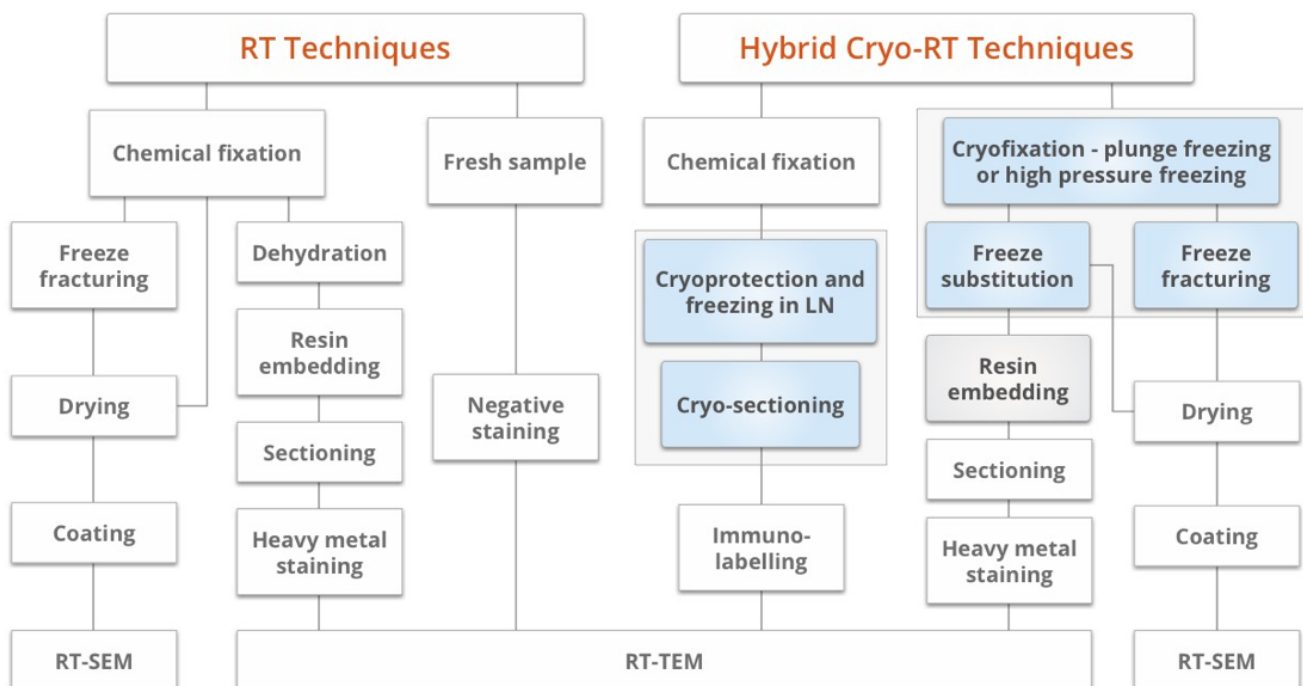
In recent times the term 'cryo-EM' has become used just for cryo-TEM structural biology studies. However, cryo-EM encompasses a range of both SEM and TEM techniques used for looking at wet samples.

In the 1930s shortly after Ernst Ruska developed the first electron microscope, Ladislaus Marton realised that when using this instrument to study biological samples there would be 'destruction of the organic cells by the intense electronic bombardment'. He suggested that new sample preparation techniques like cooling the sample would be needed. The first cryo-electron microscopy was performed by Humberto Fernández-Morán in the 1950s but the samples showed damage caused by ice crystals formed during freezing. Taylor and Glaeser in the mid 1970s showed that cooling the sample results in improved resistance to radiation damage. However, it was only in the 1980s when Jacques Dubochet found a way to freeze samples without ice crystal formation that modern cryo-electron microscopy was born.

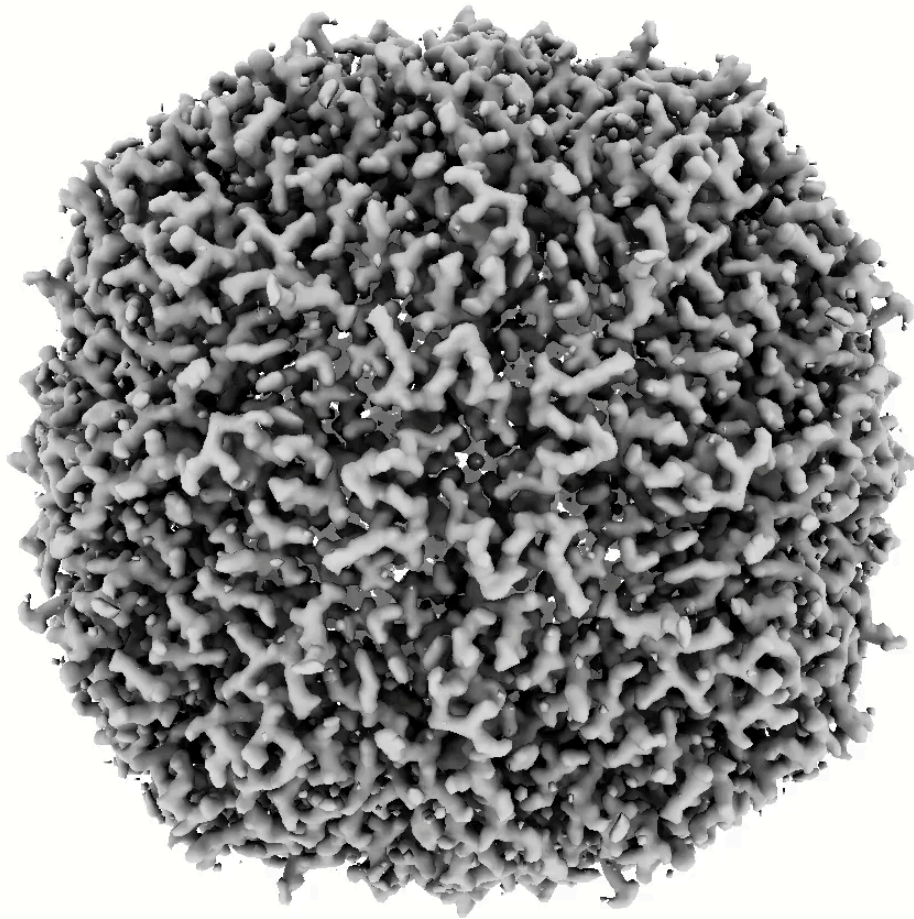
There are 3 main challenges that relate to all cryo-EM techniques.

1. Keeping the sample cold during preparation when transferring to the microscope and then during observation in the microscope. 'Cold' means temperatures usually below  $-140^{\circ}\text{C}$ .
2. Beam sensitivity. Even under cryo conditions the samples are very easily damaged by radiation from the electron beam so imaging is usually done using low dose conditions in TEM and low voltages in SEM.
3. Poor quality imaging due to the poor signal-to-noise ratio (SNR). In cryo-TEM the signal comes from interaction of electron beam with the sample itself, there is no heavy metal staining to enhance the contrast.

There are many hybrid techniques where cryo is only used for part of the workflow and the samples are viewed in the EM at room temperature. This is summarised in the flow chart below but will not be covered further in this module. This MyScope module will only cover the full cryo techniques, where the sample is frozen and then observed in the EM still in this frozen state. Some of the hybrid techniques are discussed in the Transmission Electron Microscopy module.



A comparison of room temperature (RT) and hybrid (cryo/RT) techniques for preparation and viewing biological samples for electron microscopy. Blue regions are performed under cryo conditions, pale blue can be performed at low temperatures or at RT.



*Map of apoferritin constructed using cryo-EM and single particle analysis to a resolution of 1.96Å. Movie courtesy of Michael Landsberg, University of Queensland.*

# Why cryo?

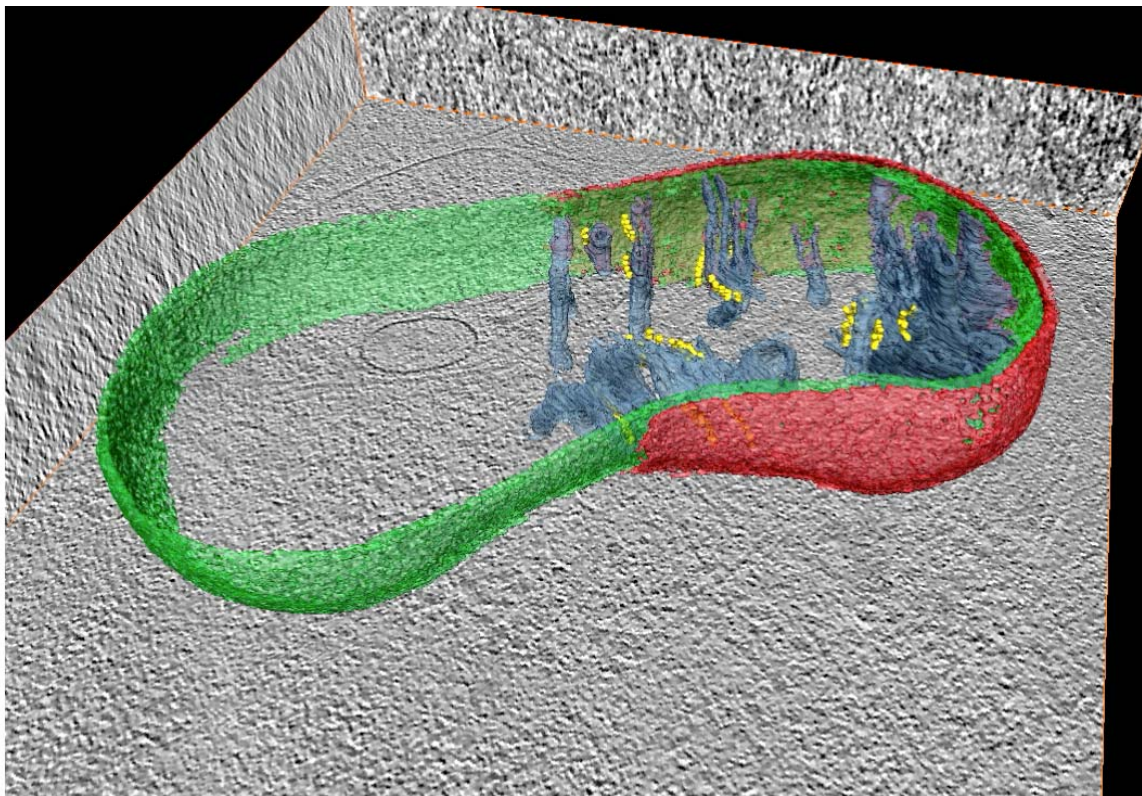
---

The main constituent of all living organisms is water. In fact, at least 70% can be water and it is involved in many of the processes of life. Within even the simplest of living organisms there are a myriad of dynamic processes going on at any one time. These make biological samples incompatible with observation in an electron microscope. The vacuum inside the microscope and the damage from the electron beam mean it's not possible to look at live organisms.

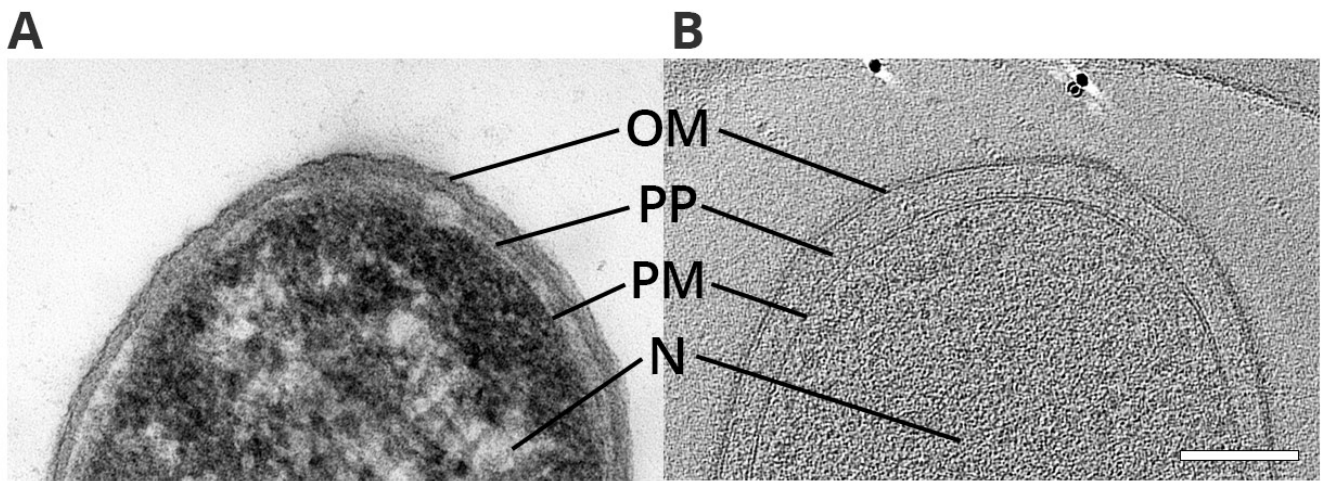
In order to preserve a living organism for electron microscopy the specimen is commonly fixed and dehydrated. Unfortunately, these chemical processes cause structural changes to the organism. The cross-linking of a fixative will lead to some physical modifications, and the removal of the water through dehydration will cause substantial shrinkage.

However, frozen water, ice, can be observed in the electron microscope. If the freezing process is done in such a way as to prevent or limit ice crystal formation, the preservation of a hydrated specimen should be of sufficiently high quality to be observed in this frozen state in the electron microscope.

Because of this ideal preservation, cryo-EM is compatible with both structural and analytical studies on biological samples from cells to viruses, food products to polymers. It offers a way to see biological structures in high resolution, even at the molecular level.



*A reconstructed and segmented tomogram of a mitochondrion in a mouse embryonic fibroblast (MEF) cell. Green is the inner membrane, red the outer membrane, blue the cristae membranes and yellow the ATP synthases. Movie courtesy of Georg Ramm, Monash University.*



A. *Escherichia coli* processed at room temperature by chemical fixation, dehydration and embedding in resin before being stained with heavy metals. B. *Legionella pneumophila* frozen by plunge freezing and observed in a cryo-TEM still in the vitrified state. The structure in A. shows many artefacts that are caused by this processing. The outer and plasma membranes are difficult to discern and very wrinkled in appearance. The peptidoglycan material of the periplasm is largely dissolved during the processing. The DNA of the nucleoid has precipitated into coarse strands. In B. the membranes clearly exhibit the true straight bilayer appearance and the periplasm is still fully intact. The DNA of the nucleoid is difficult to see as it consists of fine strands that fill the ribosome-free regions. Due to the lack of heavy metals in the sample in B. the contrast is very low. Images courtesy of Rick Webb, University of Queensland and Debnath Ghosal, University of Melbourne. Bar 100nm.



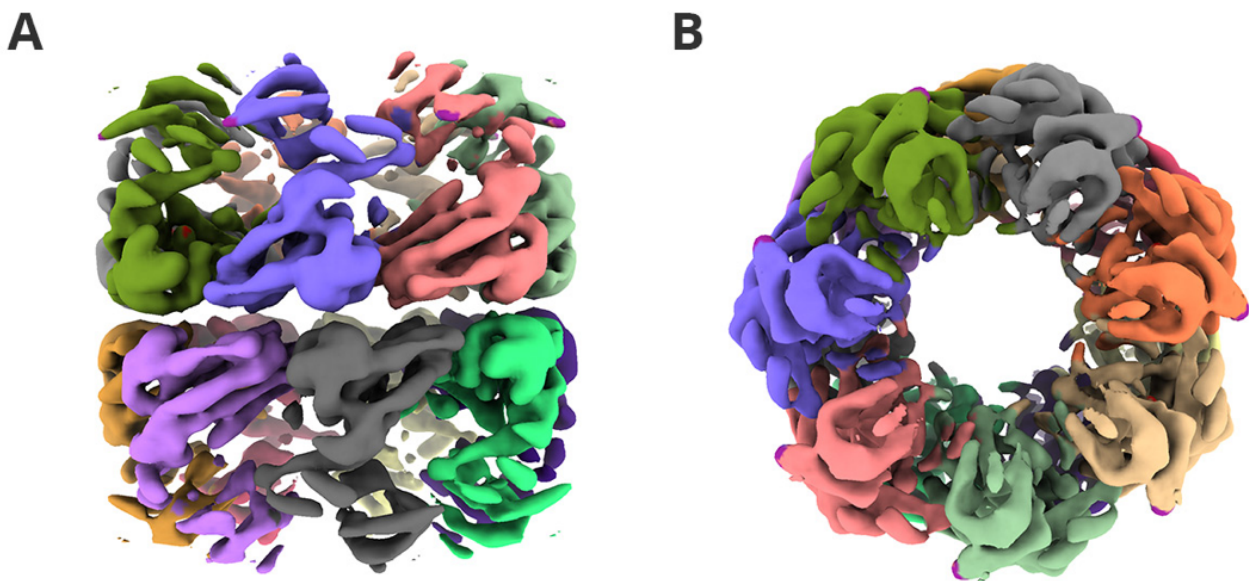
# Which cryo technique to use

The first question to ask is do I need Transmission Electron Microscopy (TEM) or Scanning Electron Microscopy (SEM)? The same things apply as for room temperature studies. In TEM the beam is transmitted through the sample so you get to see the internal information in that sample. Unfortunately, the penetrating power of the electron beam is really rather poor so you are restricted to very thin samples. The SEM is a tool for looking at the surface of a sample as the beam is scanned across it.

Cryo-TEM can involve 2D or 3D studies. 2D work usually involves single images to obtain the information about the structure. Small samples like bacteria and viruses can be observed whole but bigger samples need to be sectioned using a cryo-ultramicrotome or thinned with a focussed ion beam microscope. Often, sufficient information can be obtained from this type of study for medium resolution studies.

3D projects can be directed at the molecular, cellular or organelle level. Cryo-tomography is usually applied to cellular projects to study the structure of organelles and their relationship to one another and can be applied to a whole small sample like a bacterium. Larger specimens will need to be thinned. Sub-tomogram averaging makes use of the information within the tomograms produced by this technique to obtain molecular resolution of structures that are present in multiple copies. The importance of this technique is that it produces molecular structure in its native context within the cell.

Two other structural biology cryo-TEM techniques can be used to study molecular structures outside the cell. Single particle analysis uses a sample of purified molecular particles while MicroED utilises small crystals of the molecule of interest. Both are capable of producing reconstructions well below 3Å in resolution.

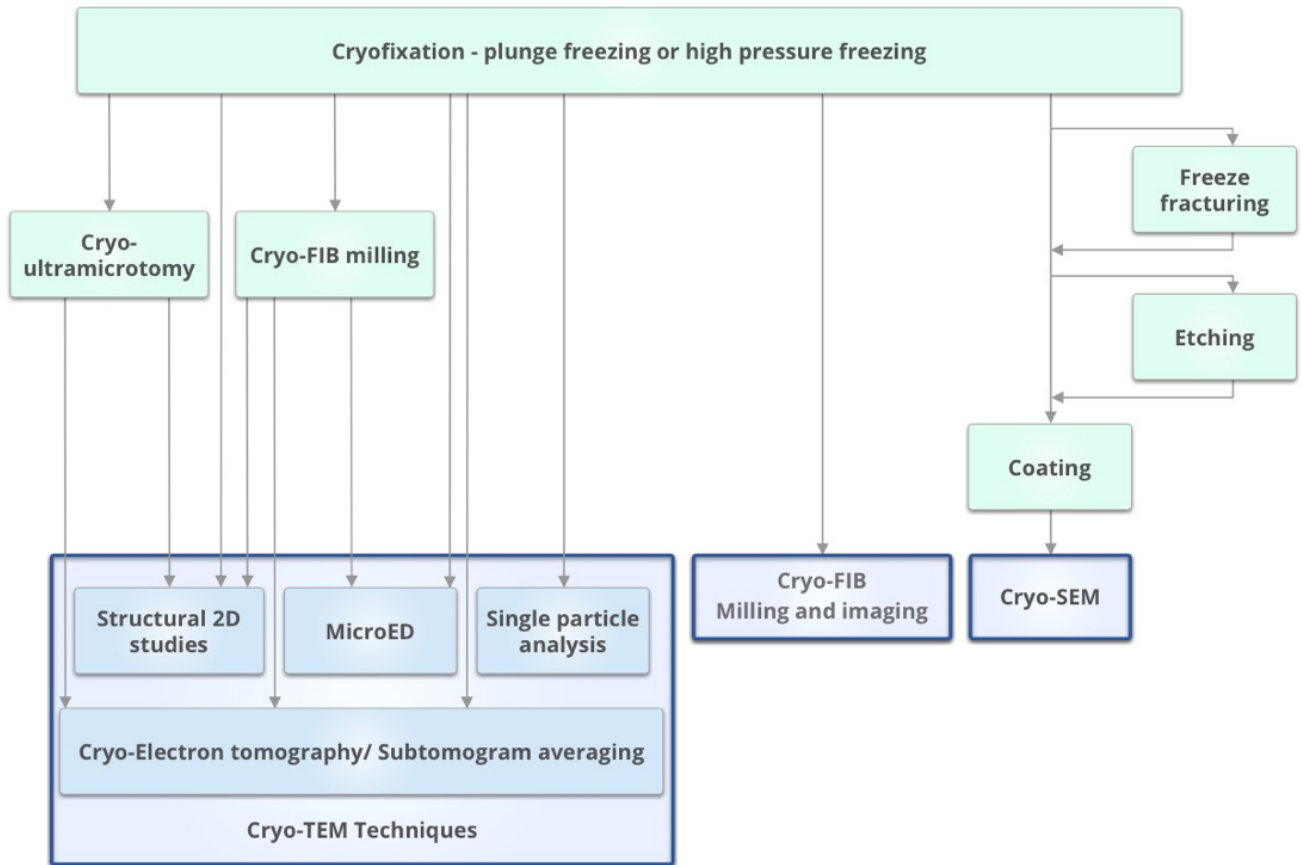


*A map of the GroEL molecule reconstructed from single particle analysis. A. Side view. B Top View. Image courtesy of Nick Ariotti, University of New South Wales.*

For the 3D studies the actual acquisition of the images in the cryo-EM is only a part of the project. The analysis of the data produced is a major part of any work.

Cryo-SEM is useful for studying any wet samples that will suffer from sample processing. These can be biological samples but also can include cosmetics, food products, gels and polymers. While cryo-SEM is primarily a technique for observations on the surface to the sample, fracturing the sample will produce a new surface, and allow studies on internal structures. While many cryo-SEM projects require only low resolutions, with the right microscope and sample preparation it is possible to obtain molecular resolutions, though usually this type of work would be done using cryo-TEM.

The biggest drawback to these techniques is that they require the use of expensive and specialist instrumentation for both the freezing of the sample and for the microscopic observations. Good access to high performance computing is also necessary, particularly for cryo-TEM studies.



A comparison of preparation techniques that can be used for different types of cryo-EM imaging and analysis of biological samples.

# Challenges of cryo

---

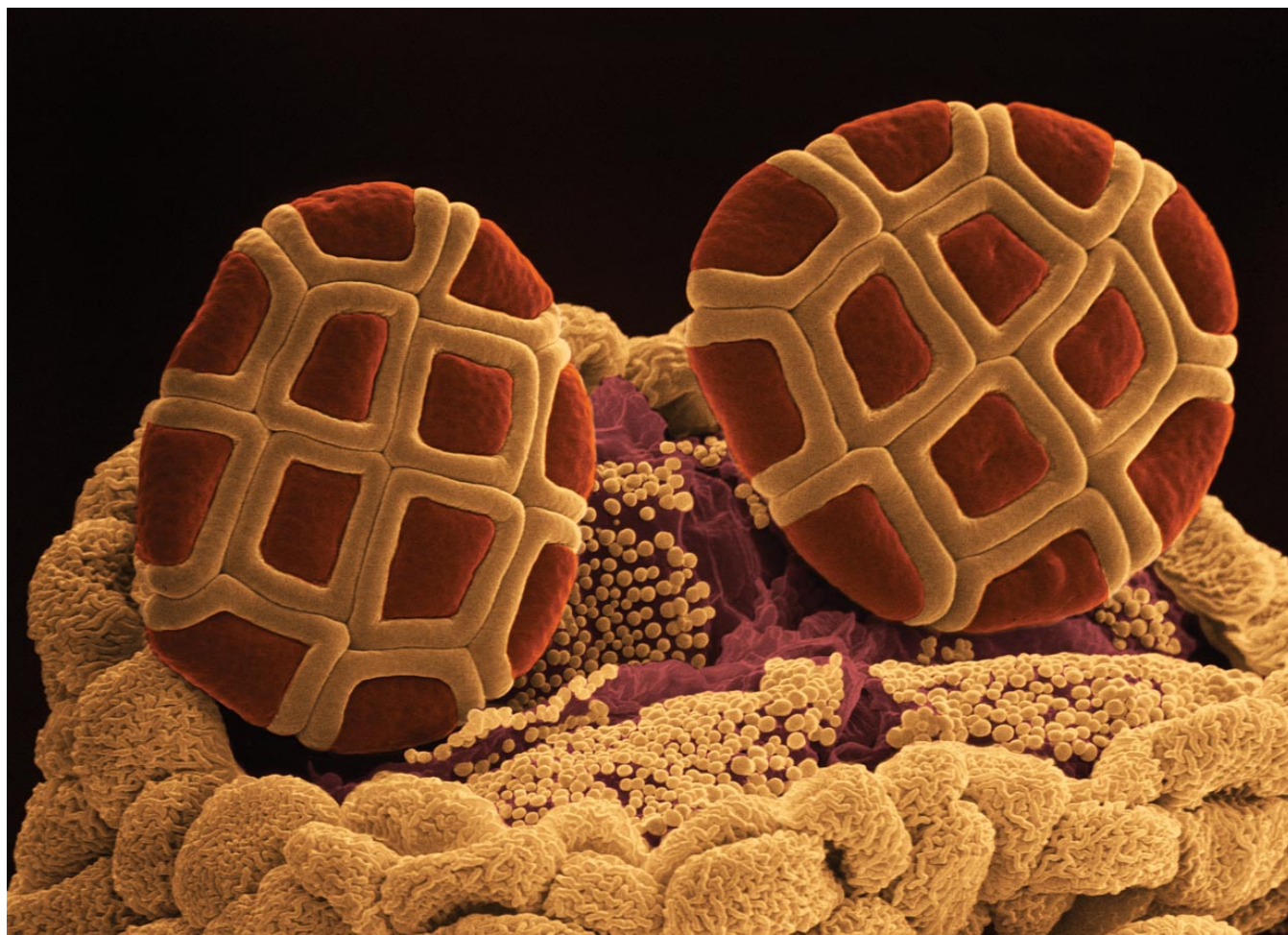
Cryo-EM is not an easy process and it throws up a number of challenges at all stages of the workflow: sample freezing, sample transfer and sample imaging.

As described previously the quality of the result in cryo-EM is only as good as the original freezing. If the freezing is poor and there is ice crystal formation that damages the ultrastructure then there is little point in actually pursuing the imaging of that sample. The rule is “Garbage in, garbage out”. Of course, the quality of the freezing demanded for a project is closely allied to the result sought by the work. For high-resolution cryo-TEM of macromolecules the quality of the freezing cannot be compromised in any way. However, for a low-resolution study in the cryo-SEM this same level of preservation is not necessary, especially as the imaging is often only of the surface of the sample where the quality of freezing will of course be much better.

The second challenge in any cryo workflow is getting the specimen from the cryo-fixation device into the cryomicroscope. There are two major issues here:

1. ensuring that the sample does not warm up as this would lead to recrystallisation and damage from the cubic ice crystals.
2. preventing frost or ice crystals from forming on the surface of the specimen. As soon as the specimen is exposed to air, even where the ambient humidity is low, condensation will take place almost immediately.

To alleviate these issues, the specimen can be kept under liquid nitrogen, operations can be performed in the dry nitrogen gas layer directly above the liquid nitrogen or the work can be done under vacuum. As air transfers are often necessary for parts of the workflow the specimen is covered by a shroud during this time. This is a metal cover that is slid over the sample and attracts most of the frost formation. Once under the microscope vacuum this can be slid back and the sample is then exposed in the clean conditions. Commercial instruments are readily available for both cryo-TEM and cryo-SEM systems to cover the issues of cryo-transfer.



In the electron microscope itself there are also many challenges. One of the most important is that the actual electron beam itself can be very damaging. In the beam-sample interaction the energy loss that occurs, especially from

inelastically scattered electrons, is deposited in the sample. This energy is strong enough to break both ionic and covalent bonds. The heat generated is also significant and can lead to sample warming.

The use of low electron doses to prevent beam damage means that the imaging is often poor as the signal-to-noise (SNR) ratio is very low. Without the use of heavy metal stains, the signal is also low as the electron beam interactions with the sample are not so strong.

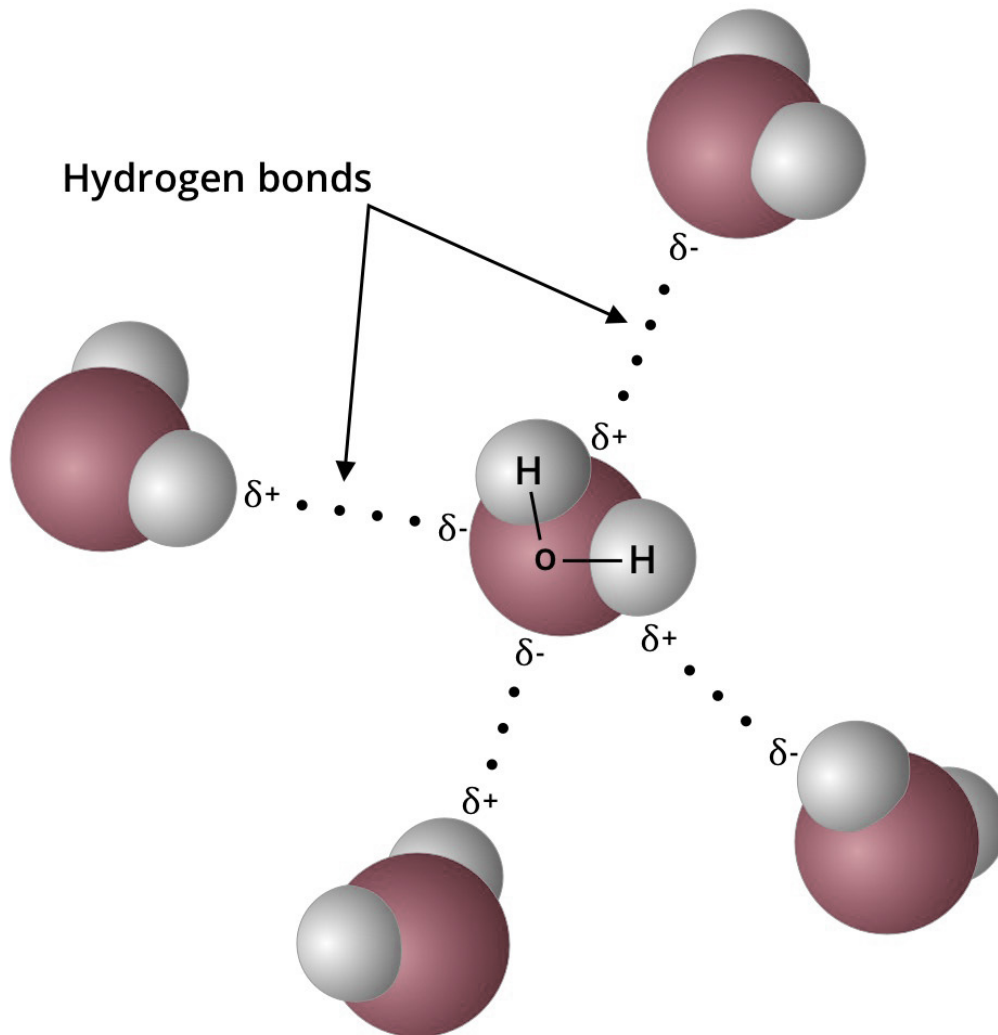
The electro-conductivity of biological samples is very poor and this can also lead to sample damage both in cryo-TEM and cryo-SEM. Observing samples at temperatures close to the temperature of liquid nitrogen reduces the radiation damage issues. It also slows the sublimation of water from the sample. It is also important to use low dose imaging conditions so fewer electrons actually hit the sample. In the case of cryo-SEM the use of low voltages will help, especially with the electro-conductivity issues.

There are many more challenges to contend with when performing cryo-EM studies and some of these will be addressed in the other sections of this module.

# Principles of freezing – Properties of water

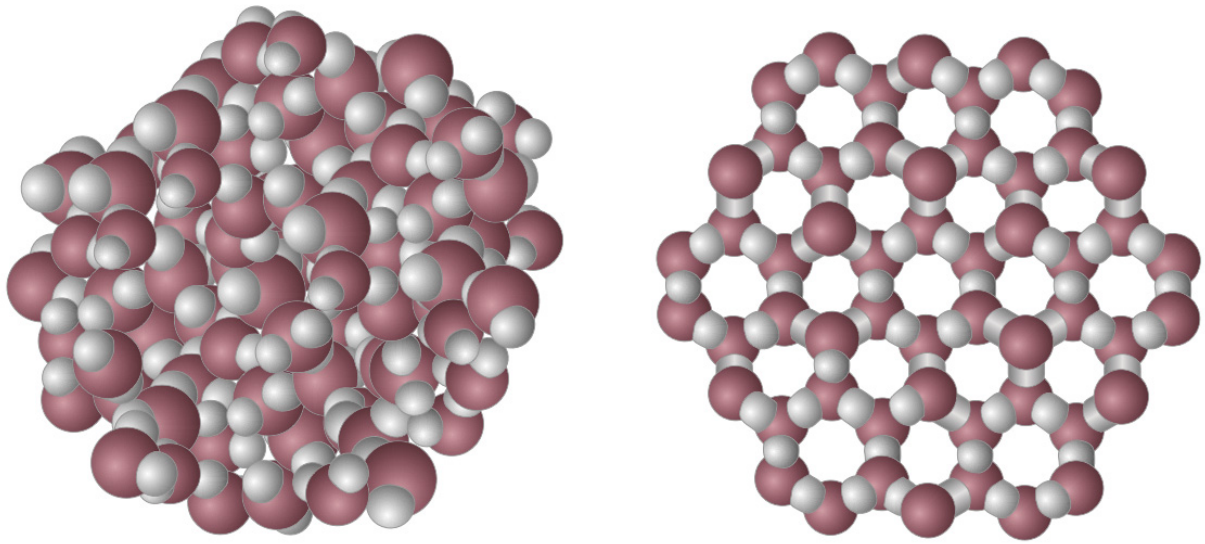
In nature, water exists in the liquid, solid, and gaseous states but under standard conditions (25°C and 1 atm of pressure) is primarily a liquid.

It has the chemical formula of H<sub>2</sub>O with the two hydrogen atoms connected to the oxygen atom by covalent bonds. Oxygen is more electronegative (holds onto its electrons more tightly) than most other elements, so the oxygen atom retains a negative charge while the hydrogen atoms are positively charged. The bent structure gives the molecule an electrical dipole moment and it is classified as a polar molecule. The molecules of water are constantly moving in relation to each other, and hydrogen bonds between the molecules are continually breaking and forming at intervals briefer than 200 femtoseconds (200 × 10<sup>-15</sup> seconds).



*Arrangement of water molecules in the liquid phase showing that because of the molecules polarity they are able to form up to four hydrogen bonds with other neighbouring water molecules.*

As the water cools, this movement slows and the molecules move gradually closer to one another. Eventually the solid state of water is formed, known as ice. Unlike most other substances, water's solid form is less dense than its liquid form as a result of the hexagonal packing within its crystalline lattice. This lattice contains more space than when the molecules are in the liquid state and is called hexagonal ice. While this hexagonal ice is the major form to be found on Earth and the common one we are all familiar with there are two other types of ice that are of interest to electron microscopists, cubic and vitreous. These will be discussed fully in the next section.



*Liquid water (left) consists of molecules connected by short-lived hydrogen bonds, with the molecules continuously moving. The hydrogen bonds in hexagonal ice (right) become permanent, resulting in an interconnected hexagonally shaped framework of molecules.*

## Freezing of water

---

Hexagonal ice crystals are usually produced when freezing aqueous solutions. These crystals are large and have devastating effects on the structure of any biological specimens. Only water molecules are incorporated in the ice crystals as they form and all solutes are concentrated on the surface of the ice crystal. The crystals are large and this solute segregation destroys the ultrastructure. You can see it manifested as netlike structures in the specimens.



*Image of a bacterium processed by high pressure freezing and freeze substitution. The quality of the freezing is poor as the ultrastructure has been badly damaged by the formation of hexagonal ice crystals that form ramifying networks that cause segregation of the cytoplasmic solutes. Image courtesy of Rick Webb, University of Queensland*

However, under specific freezing conditions it is possible to produce vitreous ice, ie. non-crystalline, amorphous ice. Unlike in hexagonal ice, in vitreous or amorphous ice there is a lack of long-range order in its molecular arrangement and the water molecules remain in their original pre-freezing disordered state. Vitrification occurs when the sample is cooled so rapidly that the water molecules are practically immobilised before ice crystals start to nucleate.

Vitrification is dependent on the thermal diffusivity, solute concentration of the sample, the sample thickness, and the pressure applied. At ambient pressure, it is possible to vitrify water films of 100nm in thickness.

Cryoprotectants act by reducing the capacity of the water molecules to participate in crystal formation. Adding chemical cryoprotectants to biological samples should be avoided as they can lead to ultrastructural changes. For an aqueous solution, increasing solute concentration will increase the time required to form ice crystals. Biological systems contain large amounts of these and they act as natural cryoprotectants as do any physiological buffer solutions. These will aid in freezing and it should be possible to vitrify a biological sample of about 10–20  $\mu\text{m}$  thick with a 'typical' solute distribution and concentration.

The two commonest successful ways to vitrify a sample for electron microscopy are to plunge it into a cryogen or to freeze at high pressure. The former is a simple method and works for thin samples, to approximately 500 nm in thickness, which suits suspensions of macromolecules, virus particles and even some single cells. For thicker samples it is necessary to use a high-pressure freezer where the sample is exposed to pressures of 2100 bar immediately prior to being frozen.

The amorphous state of the ice holds as long as the temperature is below  $-135^{\circ}\text{C}$ . Above this temperature the movement of the water molecules becomes significant enough that crystallisation takes place within minutes. This is the process of devitrification. Under these conditions, large hexagonal ice crystals cannot form, but instead, many compact sub-micrometre cubic ice crystals appear. While these cubic ice crystals are very small and probably cause little impact on electron microscopy sample preparation techniques like freeze substitution, they certainly are an issue to high resolution cryo-TEM techniques.



# Types of freezing – Plunge freezing

Rapidly plunging a specimen into a liquid cryogen is certainly the simplest means of achieving cryofixation. There is an intimate contact between the surface of the sample and the cryogen giving good thermal conductivity. Plunge freezing vitrifies samples of up to a 500 nm thick.

The temperature of liquid nitrogen at ambient pressures is very low (-196°C), and while it is cheap and readily available, its thermal conductivity is very poor making it unsuitable as a cryogen for freezing biological samples. It has a very low heat capacity, meaning only a small amount of energy needs to be transferred to liquid nitrogen to drastically raise its temperature. The boiling point of liquid nitrogen is about -196°C so as soon as something warmer comes in contact, it starts to boil. An insulating layer of nitrogen gas forms between the liquid and the specimen, preventing it from freezing quickly. This is called the Leidenfrost effect.

Odd as it sounds, under reduced pressure liquid nitrogen will undergo a phase change and become solid. So, when liquid nitrogen is put under low vacuum it will become a semi-solid slush, and its temperature is reduced to -210°C, well below the boiling point. Cooling rates can be improved using this slush as when a specimen is plunged into it, it envelops the specimen closely and extracts heat from it more efficiently without the Leidenfrost effect. This is often used for freezing of samples for low resolution cryo-SEM studies.

The most efficient cryogens are ethane and propane. Their boiling points are much higher, -89°C and -42°C respectively, so no insulating gas layer is formed between the liquid and the specimen, resulting in a very fast freezing rate. However, to liquify these it is necessary to cool them with liquid nitrogen. Ethane and propane are highly flammable and are even more so when condensed, so it is always important to take the right safety precautions when using them. Check with your local facility on safe handling procedures.

This method is only suitable for relatively thin samples as the freezing rate drops off with distance from the freezing liquid, leading to increased ice crystal growth and tissue damage with increasing tissue depth. It can be used for slightly larger samples if the region of interest lies at the surface. For cryo-SEM cooling rates often aren't so critical especially if the study does not require high resolution.

Specific instruments have been designed to allow reproducible results with the plunge freezing process. These also provide a controlled environment for the sample prior to freezing, especially in relation to temperature and humidity, to ensure the specimen is in optimal condition before freezing. However, for cryo-SEM applications it is possible often to plunge the sample by hand.

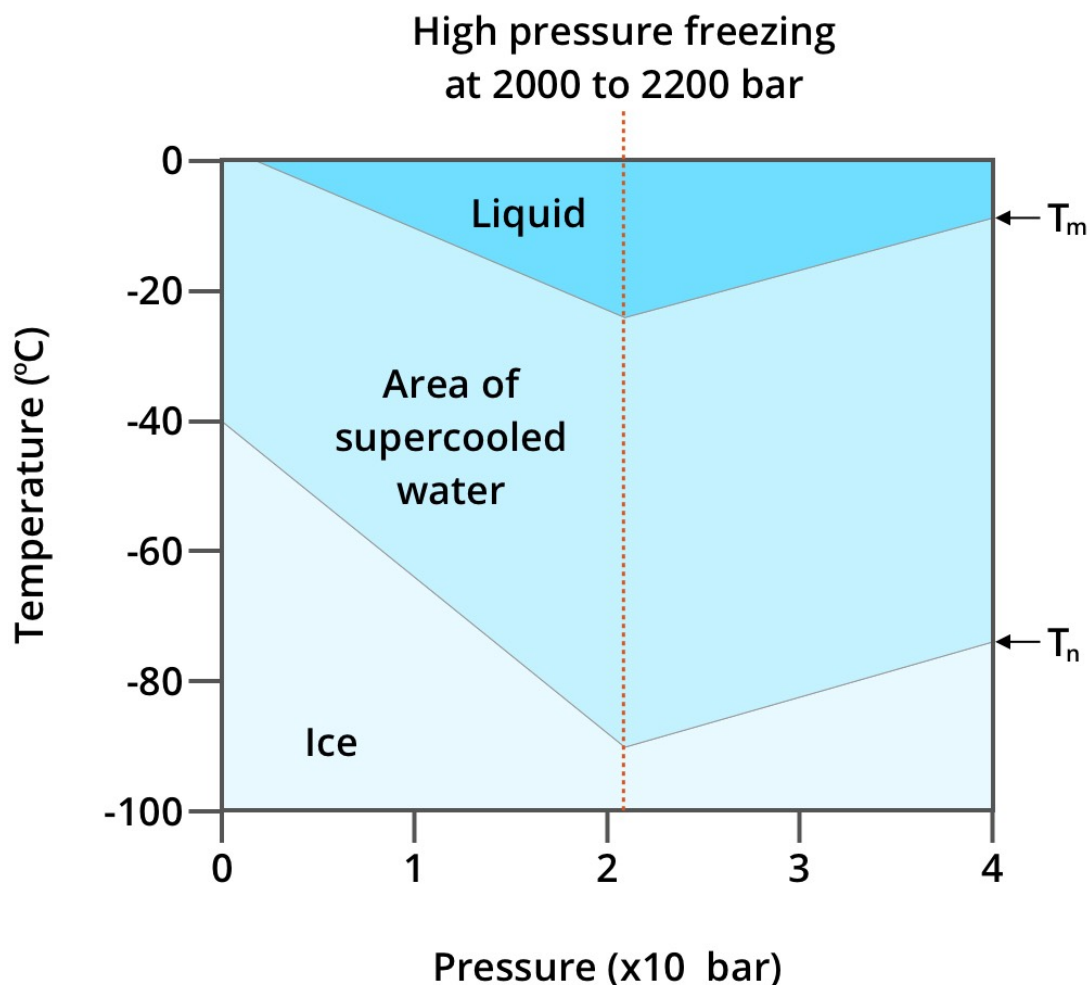
After freezing, the specimen is then stored in liquid nitrogen before being observed in a cryo-EM or processed further.

Cryogen	Boiling Point °C	Freezing Point °C	Relative Cooling Efficiency
Liquid nitrogen	-196	-210	0.1
Liquid nitrogen slush	-196	-210	0.2
Ethane	-89	-172	1.3
Propane	-42	-188	1.0

*Comparison of the cooling efficiency, melting and boiling points of cryogens. The cooling efficiency is a relative measure with the cooling efficiency of propane as 1.0.*

# High pressure freezing

Pressuring water creates several effects that can be very beneficial for freezing. When water freezes it expands in volume but the addition of high pressure opposes this, leading to the hindering of crystallisation. On the phase diagram for water the minimal melting point is at its lowest ( $-22^{\circ}\text{C}$ ) at 2045 bar of pressure. At this same high pressure, the nucleation temperature is lowered to  $-92^{\circ}\text{C}$ , as supercooling (the process of cooling below  $0^{\circ}\text{C}$  without solidification) can now occur at lower temperatures. These properties have the effect of reducing the window in which ice crystals will form and so vitrification can occur at a much lower rate of cooling. Cooling rates of several  $100,000^{\circ}\text{C/s}$  are required to vitrify a cell at ambient pressure, but only a few  $1,000^{\circ}\text{C/s}$  could be enough at 2100 bar. This means that, vitrification at this pressure is possible in approximately 10 times thicker samples than at ambient pressure. So, in a biological system this means that ice crystal formation can be prevented in 100–200  $\mu\text{m}$  thick samples with a typical biological solute concentration.

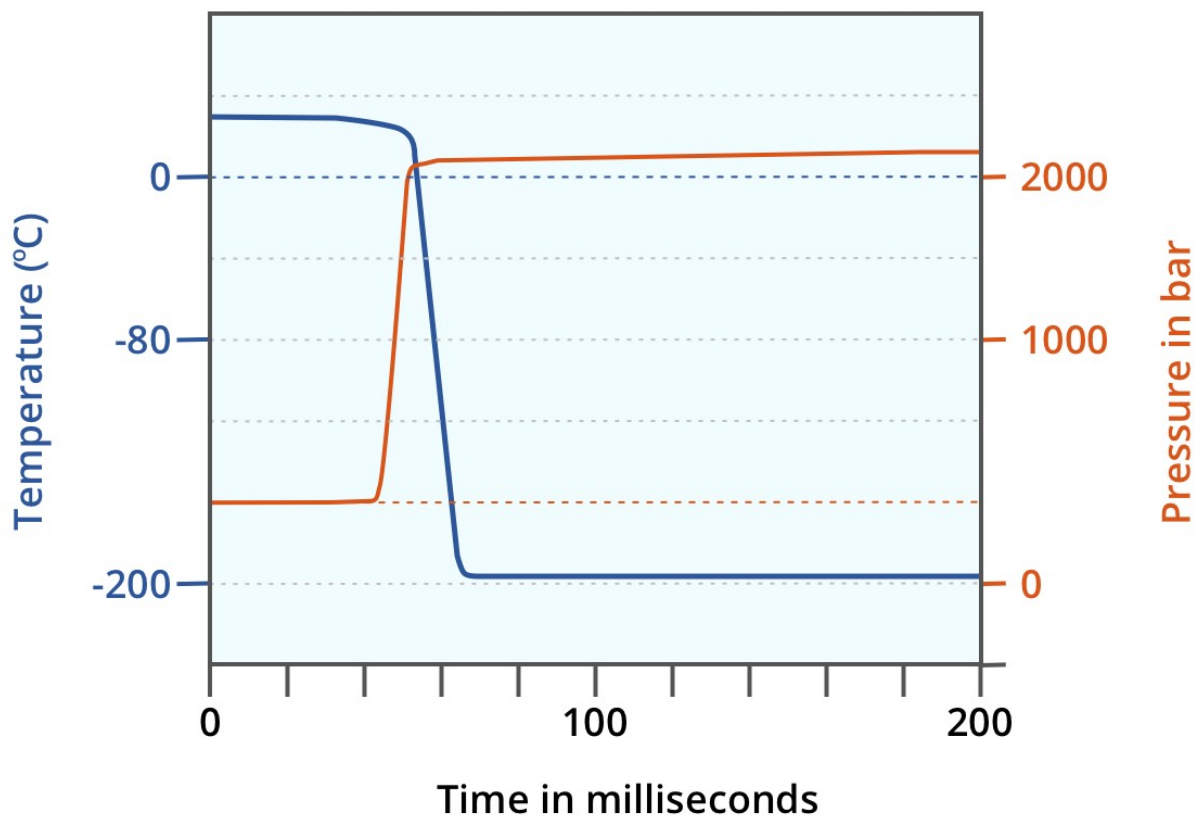


*Phase diagram for water showing the minimal melting temperature  $T_m$  and minimal nucleation temperature  $T_n$  that delineate the region of supercooling. At 2045 bar both the minimal melting temperature and the minimal nucleation temperature are at their lowest limits showing this pressure is ideal for freezing of water.*

The pressures we are talking about here are really quite substantial, 2100 bar is almost 30,500 psi. For comparison, 210 bar is the pressure in a typical scuba tank and 1100 bar is the pressure at the bottom of the Mariana Trench, 11 km below the surface of the ocean. While it would seem that pressures of this magnitude could be quite damaging to a biological specimen, in practice this does not seem to be the case and actually examples of pressure damage are rare.

Applying a pressure of 2100 bar within milliseconds while freezing the sample with liquid nitrogen then releasing the pressure after less than a second is quite an engineering feat but several models of high pressure freezers have been developed over the years. The specimen must be locked within a small pressure chamber. For this purpose, aluminium discs, often called planchettes or carriers, have been used. These are 3 or 6 mm in diameter and have chambers of varying depths. It is important that the planchette matches the depth of the sample as closely as possible. They also

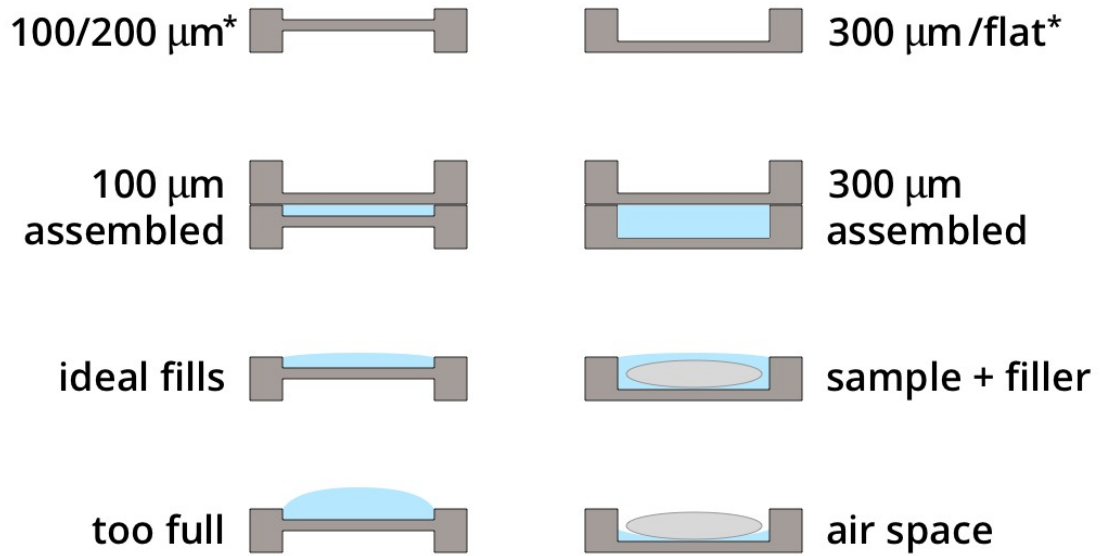
have very thin walls, 200 nm, to allow for the transfer of the pressure through onto the specimen. The fluid around the sample is replaced with an appropriate filler, a transmission fluid or an extracellular cryoprotectant solution, such as hexadecane or bovine serum albumin which will be compatible with the sample. This filler must be loaded around the sample making sure that there can be no air spaces left within the planchette chamber. The process of loading the sample is crucial to ensure that no physiological changes can occur prior to the actual high pressure freezing.



Graph of pressures and temperatures of the sample during high pressure freezing. In less than 10 milliseconds from the start of the pressure being applied it has reached 2100bar. Cooling starts fractionally before this so that the cooling rate is 20,000°C/s when the sample reaches this pressure. Under these conditions freezing takes only a few milliseconds.

**A****B****C****D**

*Aluminium planchettes as used for high pressure freezing, of A. 3mm and B. 6mm diameter. C. The planchette filled with sample and filler. D. Two planchettes sit together to form the pressure chamber with the flat surface of the top planchette being placed directly over the sample planchette. A combination of different depth planchettes can give different depth sample chambers.*



*Diagram of how samples are loaded between two planchettes for high pressure freezing. The depth of the recess in the planchettes can be 100, 200 and 300 $\mu\text{m}$ . This depth of the planchette should match the sample size as closely as possible. The level of the filler and sample should be just the a very slight convex meniscus. \* These planchette depths are the most common available but a range of other sizes are available from some manufacturers.*

## Other freezing techniques

---

Many other types of freezing have been evaluated over the years and several have been used quite successfully in producing vitrified samples for electron microscopy.

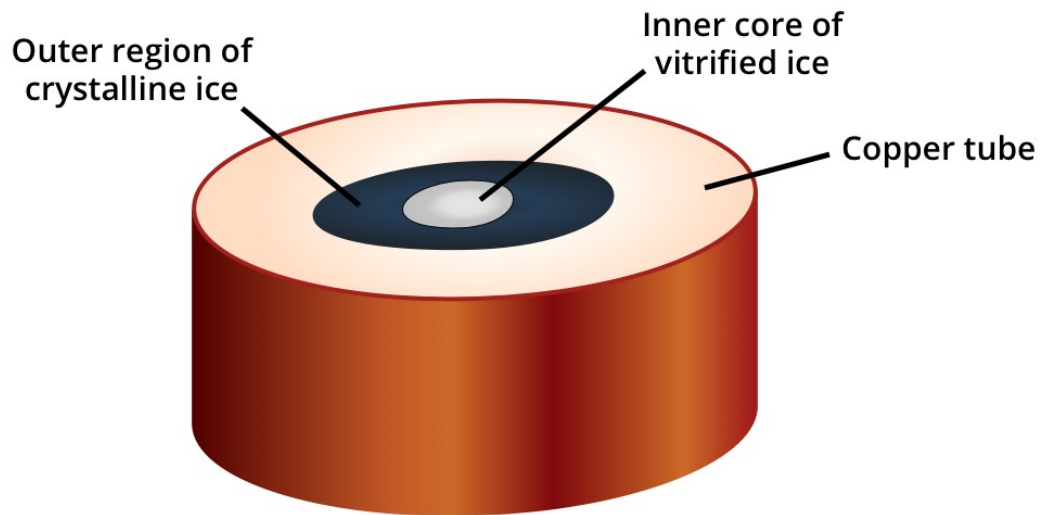
- Slam freezing is where a sample is quickly forced against a liquid nitrogen cooled polished metal block.
- With propane jet freezing, a spray of the cooled cryogen is directed at the sample (supported by a thin metal foil). As with plunge freezing the depth of vitrification in the sample is still only small. However, using a double propane jet spraying at the sample from both sides, this can be increased to some extent.

These techniques have fallen out of favour in recent times as high-pressure freezing has become more readily available.

Another technique that uses the principle of high pressure freezing is self-pressurised freezing. Here the sample is contained in a sealed thin walled copper tube that is plunged into liquid nitrogen or liquid ethane. With this slow freezing large hexagonal ice crystals are formed in the outer regions of the sample against the copper tube. These take up a greater volume than the original water and so lead to an increase in pressure in the inner region of the sample. This high pressure acts like a high pressure freezer on the sample in the centre of the copper tube and true vitrification can be achieved. While this should be appealing due to being cheap and easy, it has not been used widely.



*A. Copper tubes used for self-pressurised freezing. B. Tube filled with sample with the ends crimped to seal them before plunging into liquid nitrogen.*



*Cross-section of a copper tube filled with a frozen sample. This has been self-pressurised frozen by plunging the sealed tube into liquid nitrogen. The outer region of the ice is full of large hexagonal ice crystals, due to the slow freezing rate. Their formation increases the pressure in the central region and causes true vitrification of the sample.*

Within the field of single particle cryo-TEM, several new freezing methods have been developed to overcome some of the specific issues with freezing these types of samples. These will be discussed further in the section on single particle TEM.

# Cryo-TEM – Introducing cryo-TEM

Sample thickness limits all TEM studies and samples need to be as thin as possible to achieve high resolution. Although room temperature studies can examine samples stained with heavy metals to provide contrast, this is not possible for cryo-TEM samples. The electron beam passes through biological samples with very little interaction. This leads to very low SNR and poor contrast. Phase contrast imaging is used to enhance the contrast. Both this and electron beam radiation damage lead to a loss of high-resolution information in the images. However, through computational corrections this can be retrieved. To reduce the beam damage, imaging is always performed under low dose conditions.

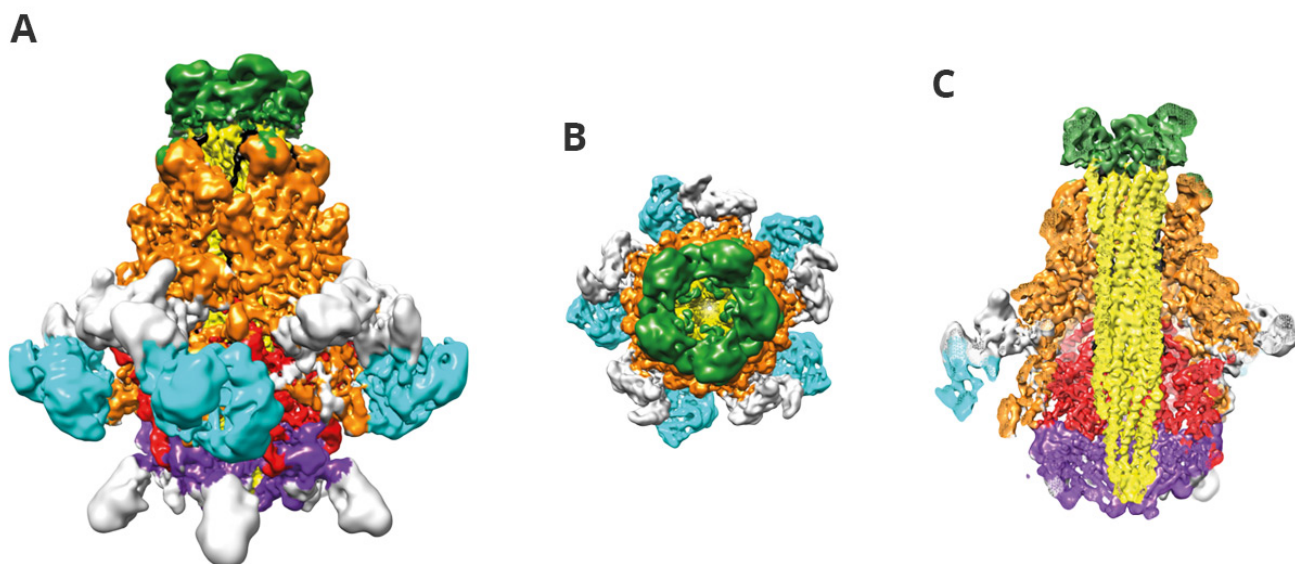
Three main types of cryo-TEM techniques are now commonly used: single particle analysis, cryo-tomography and MicroED.

- Single particle analysis involves taking large numbers of images of purified macromolecules or complexes and combining these to generate high-resolution 3D reconstructions of the particles.
- In cryo-tomography, images of the sample taken at a series of tilted angles are used to generate a full 3D reconstruction of the sample.
- MicroED utilises diffraction images of small crystals of a protein of interest. Using a set of diffraction images taken at different tilt angles the structure can be reconstructed at high resolution.

As mentioned previously many cryo-TEM studies require only 2D information without the need for the 3D reconstruction techniques. This data can usually be acquired from a single image, meaning greater electron doses need to be used. The sample preparation and microscope viewing are the same as for cryo-tomography but without the need for the tilt series.

The acquisition of the image is only a small portion of the workflow and it is the image processing that can be the major part of any cryo-TEM project.

In recent times there have been major advances in design of the cryo-TEMs and cryo-preparation instruments along with improvements in the detectors for the acquisition of the images. There have also been major software developments that aid in the control of the microscope and the processing of the images. In 2014 Werner Kuhlbrandt coined the term “The Resolution Revolution” to describe the huge advance in this field.

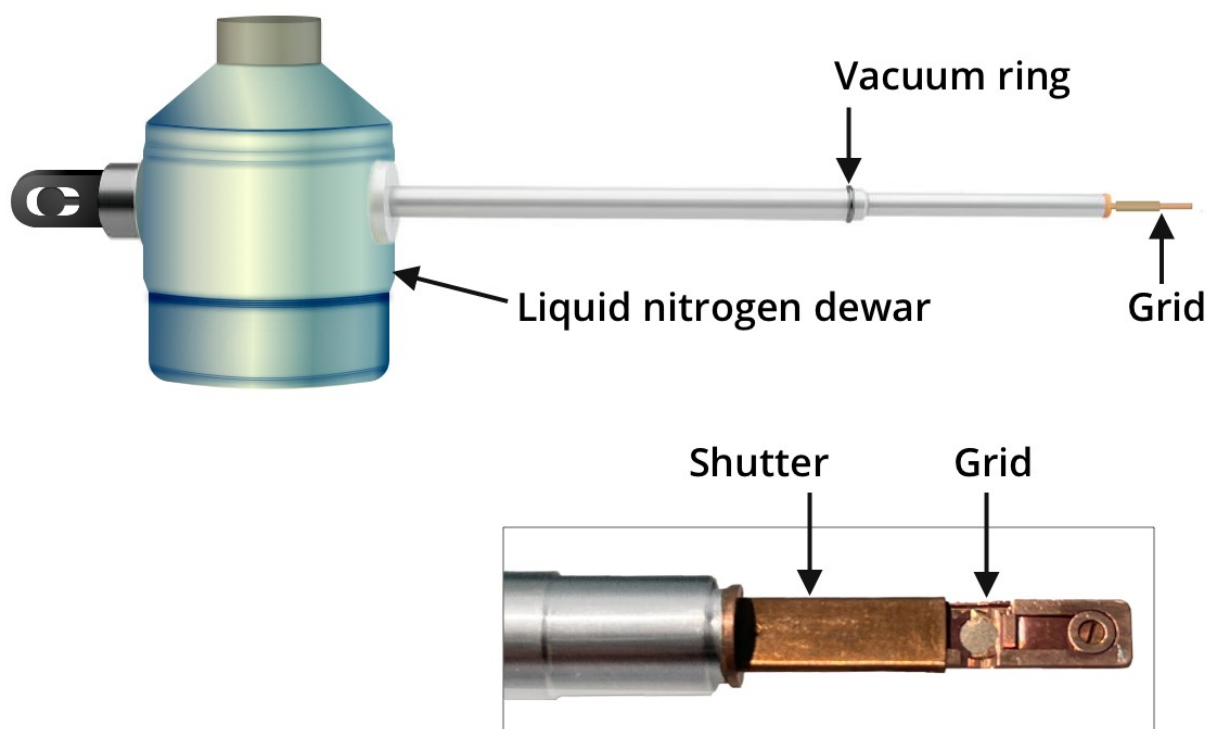


3D Cryo-EM map of the YenTcA module of the *Yersinia entomophaga* ABC toxin as A. side and B. top view orientations. C. A cut-away view of the map. Image courtesy of Sarah Piper and Michael Landsberg, University of Queensland.



## The cryo TEM – The microscope

A relatively standard TEM can be used for cryo-TEM work although some additional features are necessary. The most important of these is a cryo-EM holder. These have a small liquid nitrogen dewar sitting on the external end and by a thermally conductive connection, the tip, where the TEM grid will be placed, is cooled to temperatures below  $-160^{\circ}\text{C}$ . The holder also contains a shutter or gliding shield to protect the sample from ice contamination during the transfer to the TEM. The other important addition to a standard microscope is an efficient anti-contaminator sitting on both sides of the sample removing water molecules that are given off from the sample during observation to prevent them from recondensing onto the sample.

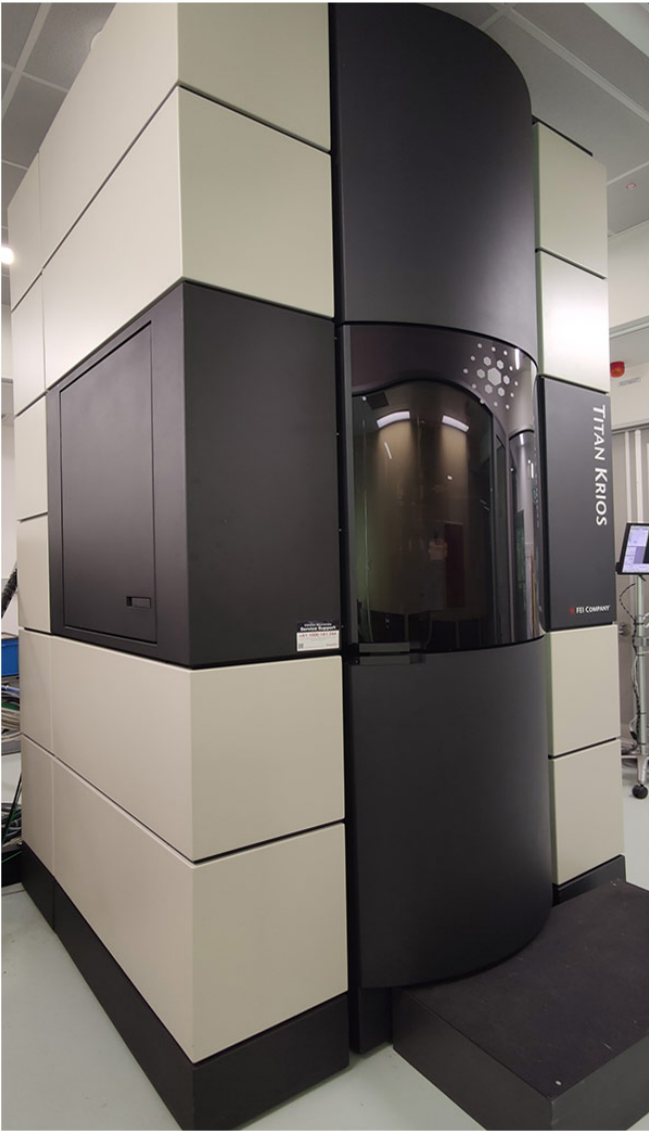


*Cryo-EM holder for a standard TEM. This holder takes a single grid. The shutter closes over the grid to prevent frost deposition on the sample during transfers.*

However, now dedicated cryo-TEMs are available. These are sophisticated instruments designed specifically for this function, providing control of all operations in the workflow. They can take multi-grid cartridges to improve efficiency. All operations can be performed in a more automated fashion and usually these are run from a remote location to ensure the operating conditions of the microscope can be as stable as possible. The conditions of the room in which they are installed requires the highest specifications in terms of isolation from vibration and electrical fields and control for stability of temperature and humidity.

Initially it was thought that to obtain the highest resolution information it was necessary to use a high voltage cryo-TEM, usually 300kV, as the wavelength is shorter and the amount of inelastic scattering and specimen charging would be lower. However, it has now been shown that high resolution single particle reconstructions of even small proteins are possible with the much cheaper 200kV instruments. However, a 300kV instrument is more applicable to cryo-tomographic studies.

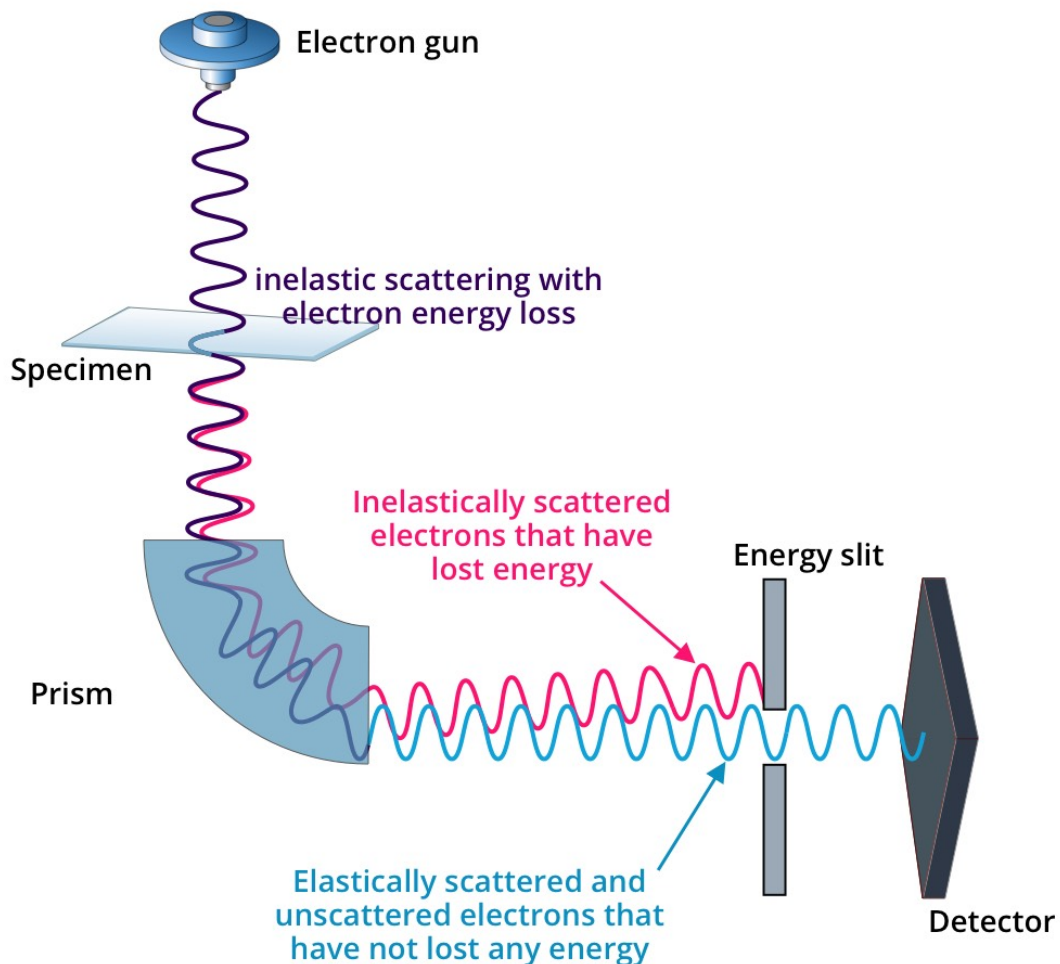
These microscopes are equipped with electron energy filters, direct electron detectors and in some cases phase plates.

**A****B**

*A. A modern dedicated cryo-TEM. B. The covers have been removed to show typical TEM features, such as the microscope column. The covers help in isolating the microscope from the environment to give stability while imaging. Image courtesy of Hari Venugopal, Monash University.*

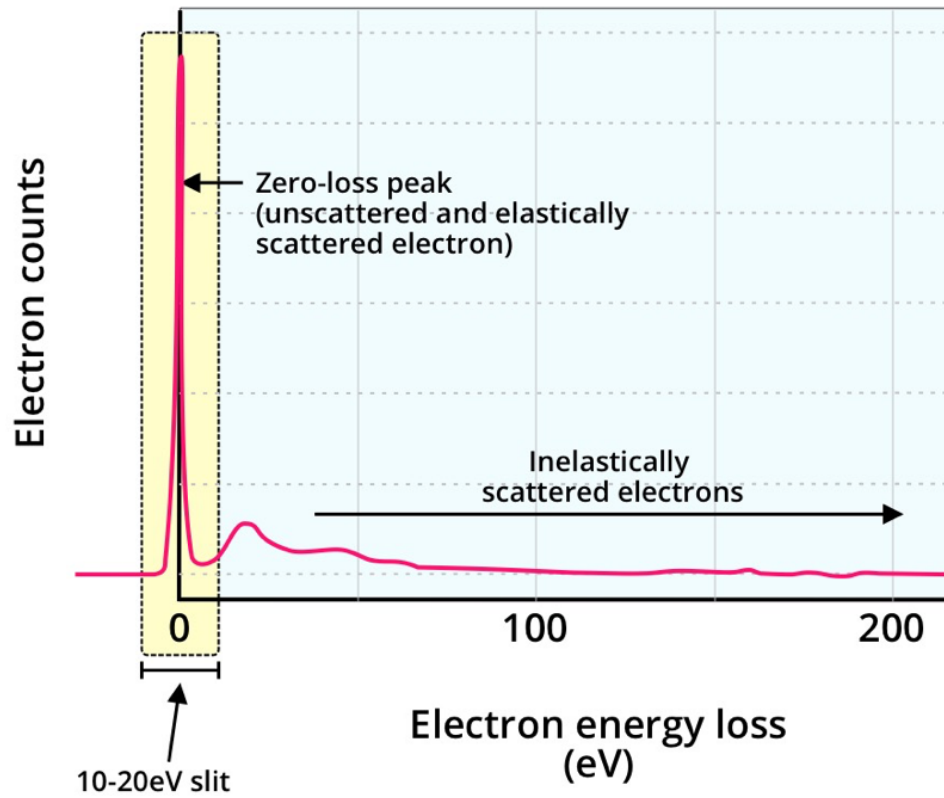
# Electron energy filters

An energy filter, either in-column or post-column, removes the inelastically scattered electrons so that only the elastically scattered and unscattered electrons are involved in forming the image. A full discussion on these different electron types that result from beam-sample interactions is given in the section on image formation. The inelastically scattered electrons cause background and so reduce the signal-noise-ratio dramatically. The filter improves the contrast and also clarity of the image formed by only allowing use of these so called zero-loss electrons (unscattered and elastically scattered).



*Diagram of an energy filter showing the energy slit which blocks the inelastically scattered electrons but allows unscattered and elastically scattered electrons to pass through.*

The energy filter is a magnetic prism with a selective energy slit that only lets through electrons with a specific energy loss. A stable narrow slit width of 10-20 eV is generally used. The narrower the slit the better the SNR and contrast but this leads to a cut off in signal. Energy filters are now used in all cryo-TEM studies when available.



Graph of energy loss electrons produced when an electron beam interacts with a specimen. The zero-loss peak consists of elastically scattered and unscattered electrons. An energy slit of 10-20eV in an energy filter would block the inelastically scattered electrons but allow through these elastically scattered and unscattered electrons.

# Phase plates

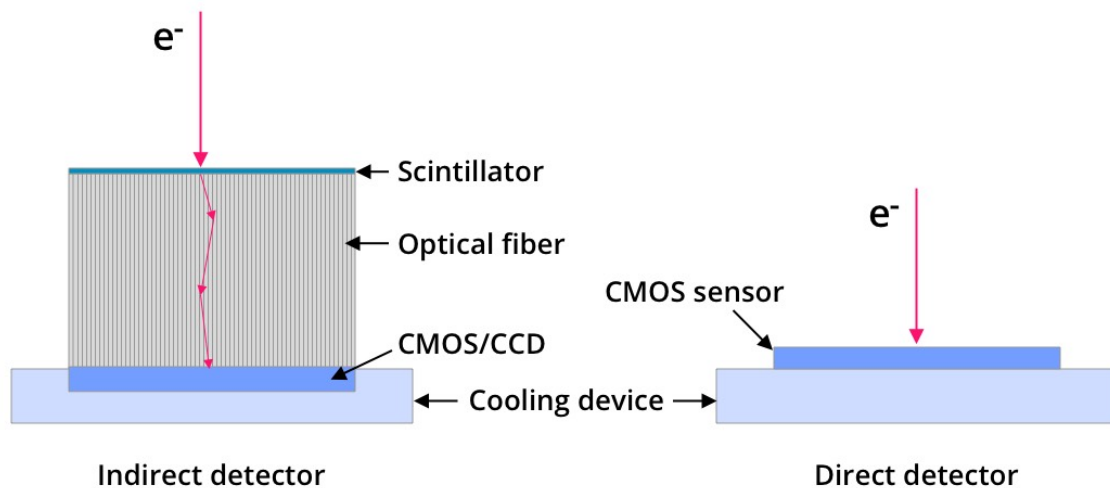
---

Phase plates enhance contrast by placing an aperture at the back focal plane of the microscope to induce a phase shift. This means that less defocus can be used to achieve the higher contrast. Defocus is the means of imaging used in cryo-EM studies and will be described fully in the section on Image Formation. While initially it was thought that the added contrast advantages of phase plates would be beneficial for SPA of small particles their full value has not been proven because of postprocessing issues and loss of signal. They have been more useful for cryo-tomography studies and a further explanation of them is given in that section. New types of phase plates are being developed that show great promise for future.

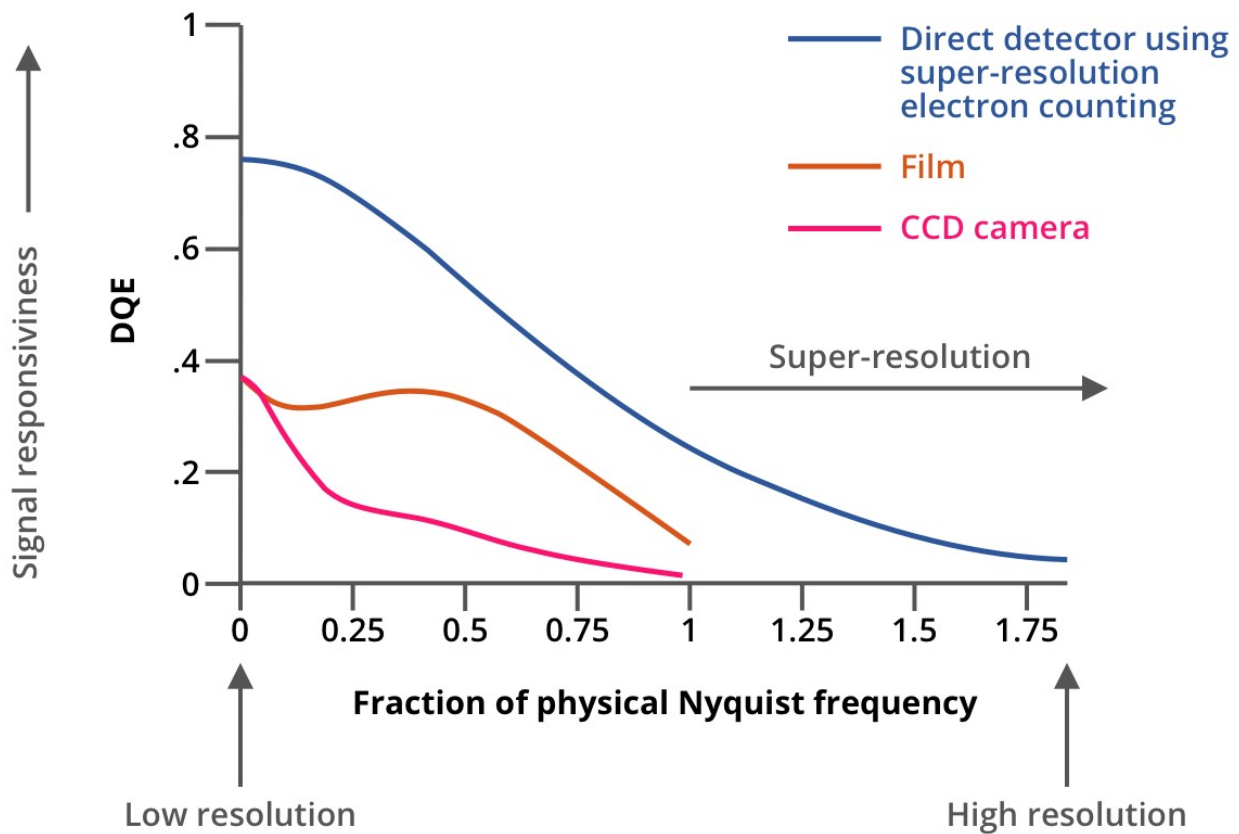
# Electron detectors

Recently there has been a significant improvement in the ability to capture images in the TEM with the development of the direct electron detector. The detective quantum efficiency (DQE) is a measure of the combined effects of the signal (related to image contrast) and noise performance of an imaging system. The DQE of photographic film is high, but it suffers from a limited dynamic range, is labour intensive and slow to work with. The use of digital camera systems has taken over completely in electron microscopy. Charge-coupled devices (CCDs) that employ scintillators to convert electrons to photons suffer from a poor DQE. CMOS cameras have improved DQE and speed but also initially used scintillators.

Direct electron detectors are directly exposed to the electron beam. These systems offer higher DQE than scintillator-coupled cameras. The monolithic active pixel sensor (MAPS) for TEM is a CMOS based detector that has been radiation hardened to withstand direct exposure to the electron beam. The sensitive layer of the MAPS is typically very thin, which reduces the lateral spread of electrons from the electron beam within the detective layer of the sensor, allowing for smaller pixel sizes. Smaller pixel size allows for a large number of pixels to be incorporated into a sensor. Detection and readout occur in a single layer giving a continuous and fast readout with the recording of single electron events. These fast readout speeds offer the possibility to fractionate the dose over multiple frames so images saturated with electrons can be removed leaving only a subset of images with the best DQE and signal-to-noise ratio. Their introduction has revolutionised the field of cryo-EM to allow routine reconstruction of structures at high resolution.

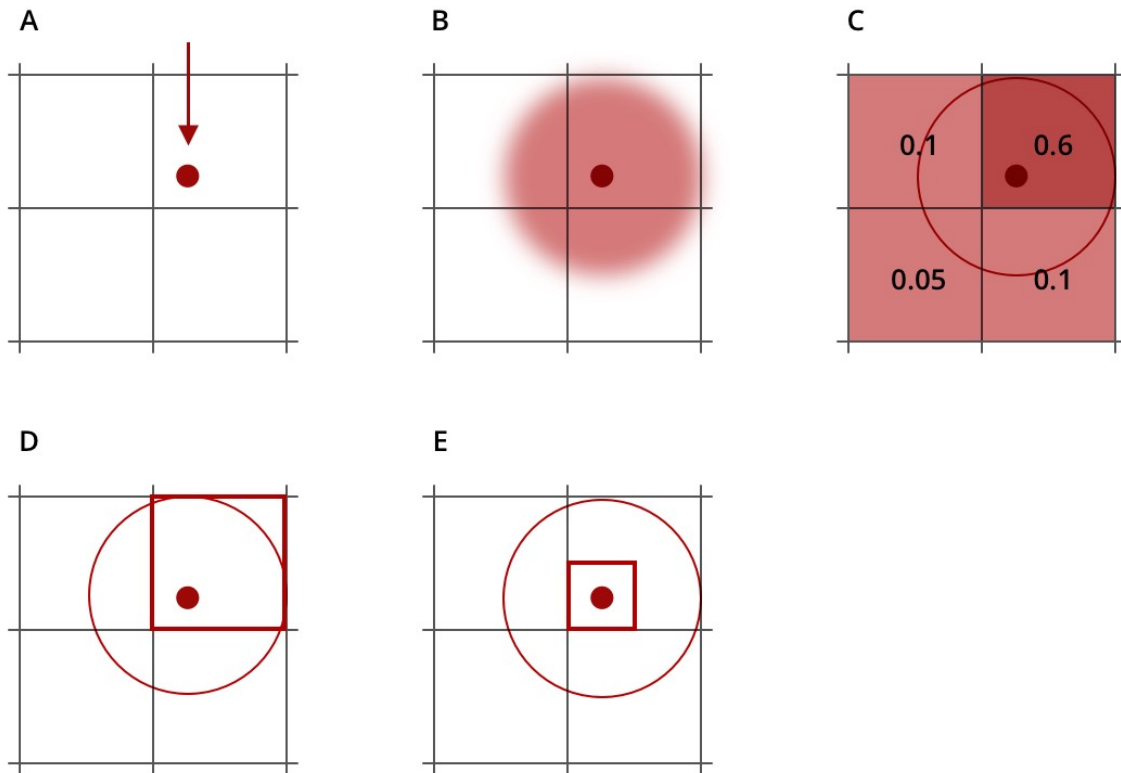


*Comparison of direct electron detector with indirect CMOS and CCD detectors.*



Comparison of direct electron detector with indirect CMOS and CCD detectors. Fraction of Nyquist is a measure of the resolution. By allowing sub-pixel resolution (see below) the super-resolution mode of a direct electron detector takes it beyond the theoretically possible resolution. After [Gatan](#).

In electron counting mode, the direct electron detector runs fast enough for individual electron events to be identified separately. This reduces electron scattering and so improves the DQE. Using super-resolution mode, the detector can read the signal from each electron in a small cluster of pixels and calculate the centre of the electron event with sub-pixel accuracy. This effectively gives a fourfold improvement in the number of pixels, taking resolution beyond the theoretically attainable physical Nyquist limit, defined as twice the pixel size.



*Illustration of electron counting and super-resolution in a direct electron detector. A. An electron enters detector. B The electron signal is scattered. C. Charge collects in the 4 surrounding pixels. D. The event is counted in the highest charge pixel (electron counting). E. From the differential charge in the surrounding pixels the event is calculated to the sub-pixel (super-resolution).*



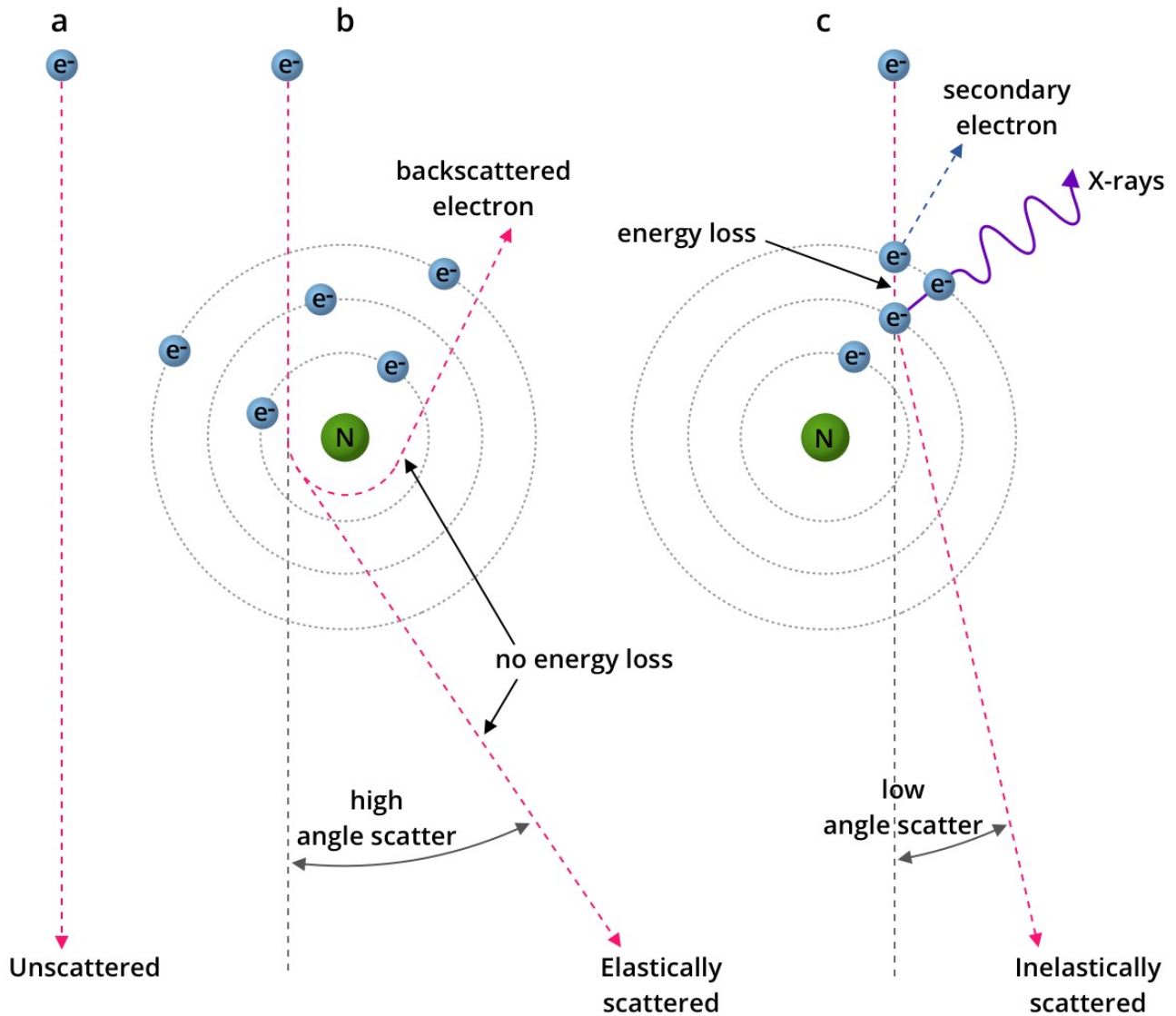
# Imaging in a cryo-TEM – How images are formed

---

To interpret what is being presented in the image you need to understand the factors involved in the production of an image in a cryo-TEM. The electron beam-sample interactions are directly responsible for the resulting image. It is therefore essential to appreciate fully what is going on, especially as the contrast of the samples is inherently very low. To understand how electrons behave, it is important to realise that they can have properties that make them behave like a particle and properties that make them behave like a wave.

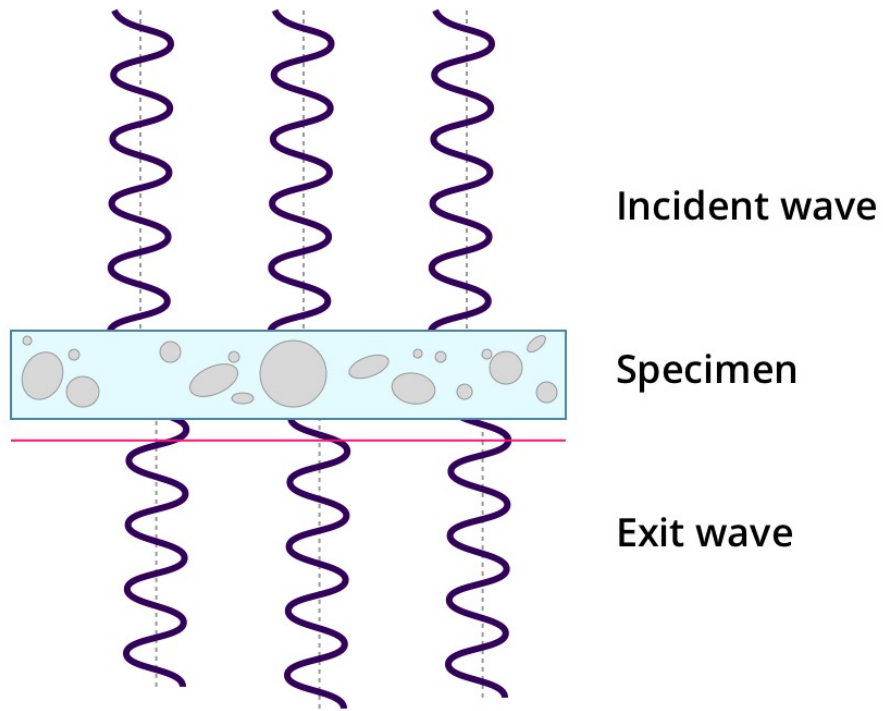
To appreciate what is happening in electron scattering you must think of electrons as particles. Scattering is what happens when an electron interacts with an object and is deviated from its original path down the microscope column by this interaction. There are three possible types of interaction: unscattered electrons, inelastically scattered electrons and elastically scattered electrons. The combination of these produce a TEM image.

Unscattered primary electrons have passed between atoms of the sample without interacting with them so their velocity and direction remains unchanged. If the electron interacts with an atom in the sample but does not lose any of its energy, it is deflected and emerges as an elastically scattered primary electron. If the electron interacts with an atom in the sample and loses some of its energy to the atom it hits, it is deflected and slowed down, emerging as an inelastically scattered electron. Because of their lower velocity, inelastically scattered electrons are affected more strongly by the magnetic lenses in the TEM and will be focussed by the microscope at a higher position in the column than the elastically scattered electrons. As a result, they do not contribute to contrast but increase the background noise in the image. In cryo-TEM inelastic scatter interactions are a serious problem as they cause radiation damage to the sample, reduce the SNR and effect the ultimate resolution. It is these inelastically scattered electrons that are removed by the energy filter.



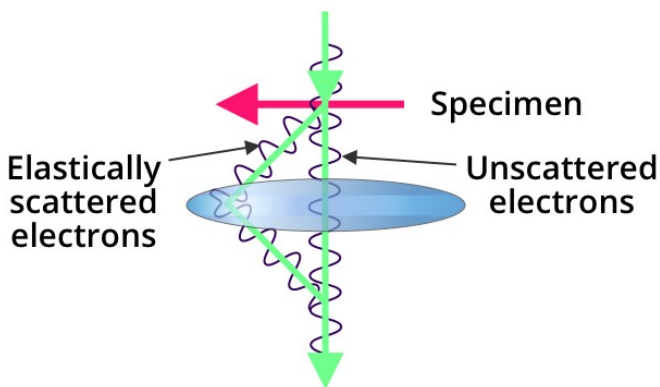
Three types of electron interactions with a specimen. A. Unscattered electrons that pass directly through the specimen without any interaction. B. Elastically scattered electrons that don't lose any energy in their interaction with the specimen atoms. C. Inelastically scattered electrons that lose energy in their interaction.

Understanding electrons as waves, helps to understand contrast in the electron microscope. The wavefront of the elastically scattered beam is dispersed in many directions simultaneously and the amount of signal scattered at a particular angle depends on the structural detail of features in the sample. So, if a sample contains lots of fine detail, the signal will be scattered at high angles. These scattered waves are subsequently focused by the microscope lens to form an image, but because of their different scattering angles, some will have to travel further than others to arrive at the electron detector. These differences in path length cause the unscattered and elastically scattered waves to interfere with each other, in some cases reducing the signal and in others, enhancing it. These phase shifts lead to enhanced contrast (phase contrast) in the image.

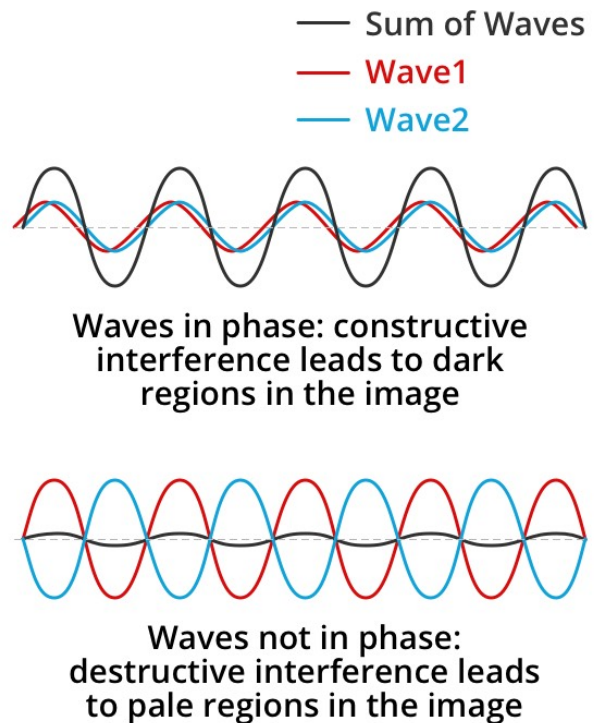


Electron wave interactions with a specimen. All the incident waves are in synchrony but after interaction with the sample there is a phase shift in the waves so the synchrony is lost.

### Phase contrast



### Interference of waves



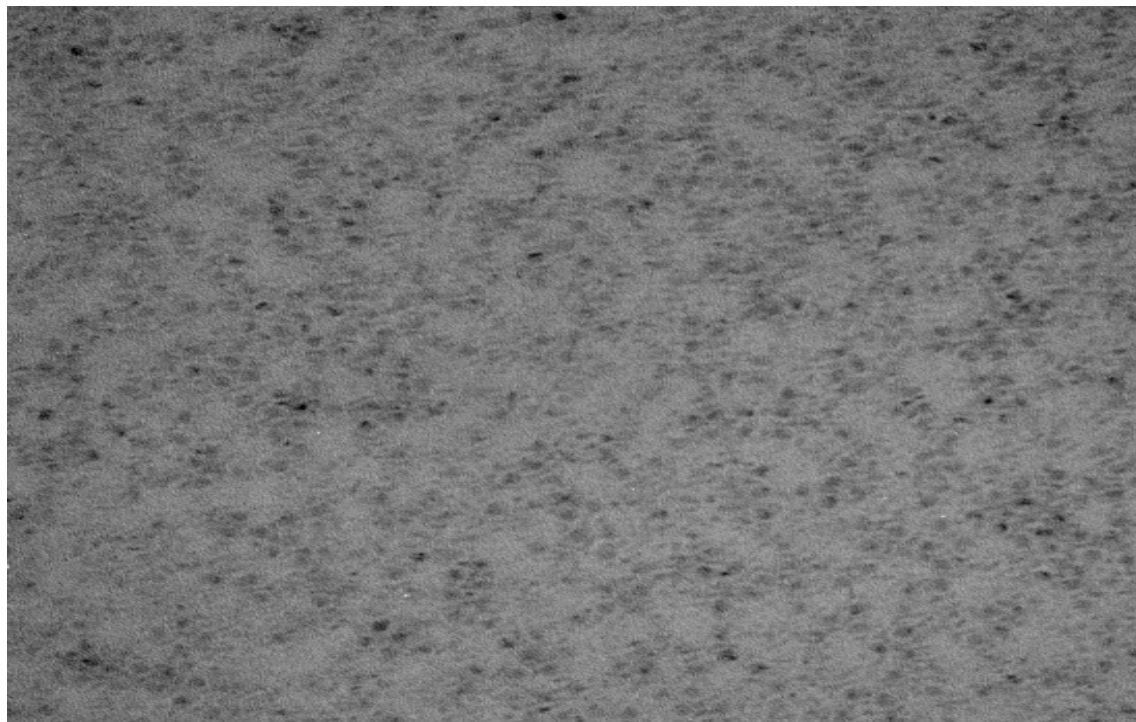
Phase contrast imaging of a typical unstained cryo-sample. When elastically scattered and the unscattered waves converge the waves in phase result in constructive interference which leads to a more intense signal and therefore darker regions in the image. If the waves are not in phase the result is destructive interference which leads to a reduced signal and therefore lighter regions in the image.

When you change the focus you change the path length of the waves. All the phase information will shift and different features will now become visible in the image while others will be lost. This will shift which wave interactions are being imaged on the detector. The more you defocus the image, the more phase contrast you get. While this added contrast

is good for larger structures, the finer detail can be lost if the defocus is too great. It is therefore a trade-off between the two and you need to capture images at different defocus settings for each sample.

The effect of defocus phase contrast is to change the information captured in the image. By working with Fourier transforms of the images, it is possible to retrieve the true information so that when the inverse Fourier transform is applied, a corrected image is generated. This is described in the next section.

Defocus is the main way of introducing phase contrast into cryo-TEM images. However it is also possible to add a phase plate at the back focal plane of the microscope which will also lead to a phase shift. Phase plates are fully described in the section on cryo-tomography .

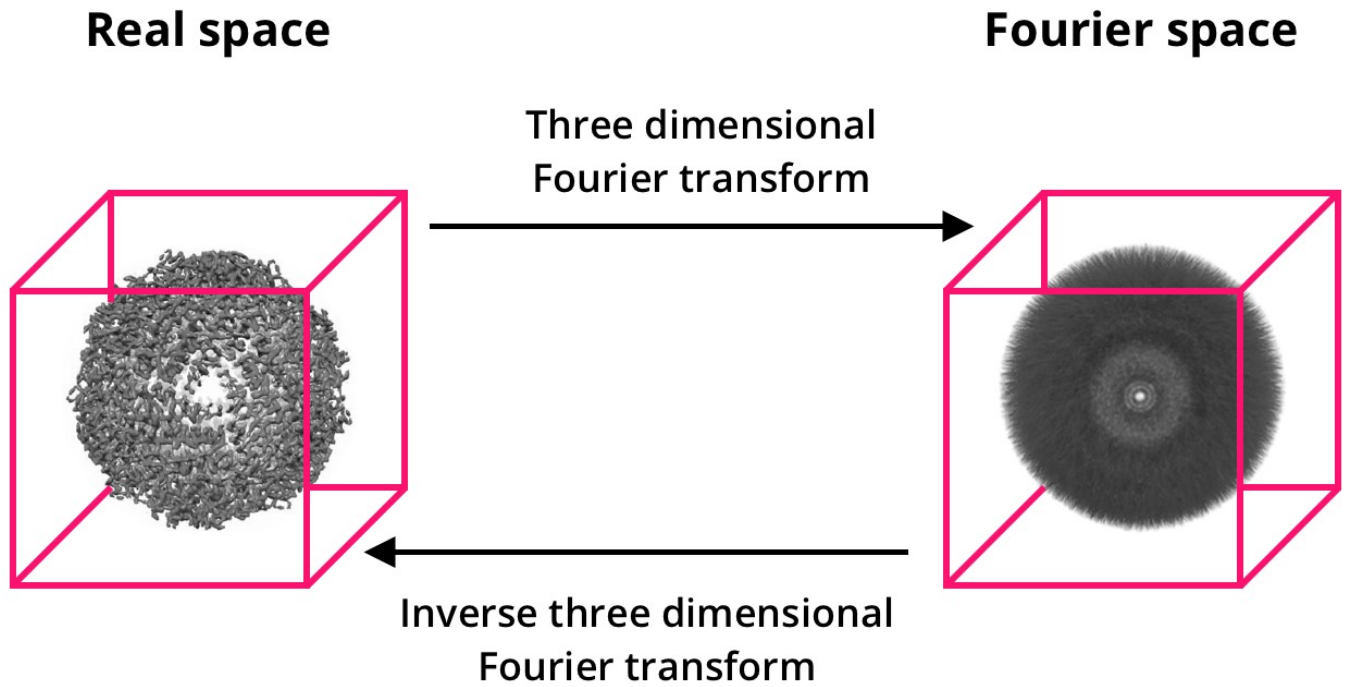


0nm

*Focus has a major effect on images. Changing the focus settings on this image of negatively stained apoferritin particles you can these effects. The In focus image show low contrast but with low defocus the phase contrast is enhanced and it becomes easier to see detail in the image. With high defocus the image becomes greatly affected. With overfocus a strange fringe effect of dark and light bands is produced and the contrast is inverted.*

# Fourier Transformation – Why do Fourier transforms

In collecting the images on the cryo-TEM, noise has been reduced through the use of energy filters, and contrast enhanced with defocus-generated phase contrast. These were described in earlier sections. This image still needs a lot of correction to compensate for aberrations introduced by the microscope and for the effects of defocus. The corrected data can then be used for the structural reconstructions. In most cases, you first need to first perform a Fourier transformation on the data so it can be easily manipulated mathematically. Once corrections have been applied, an inverse Fourier Transformation will generate a corrected image.



*This section provides a brief introduction to Fourier transforms and their use in cryo-TEM image processing.*

# What is a Fourier Transform?

---

A Fourier transform is a mathematical operation that is widely used in processing and analysing all types of digital images, sound, video and any other large complex datasets that makes them amenable to manipulation.

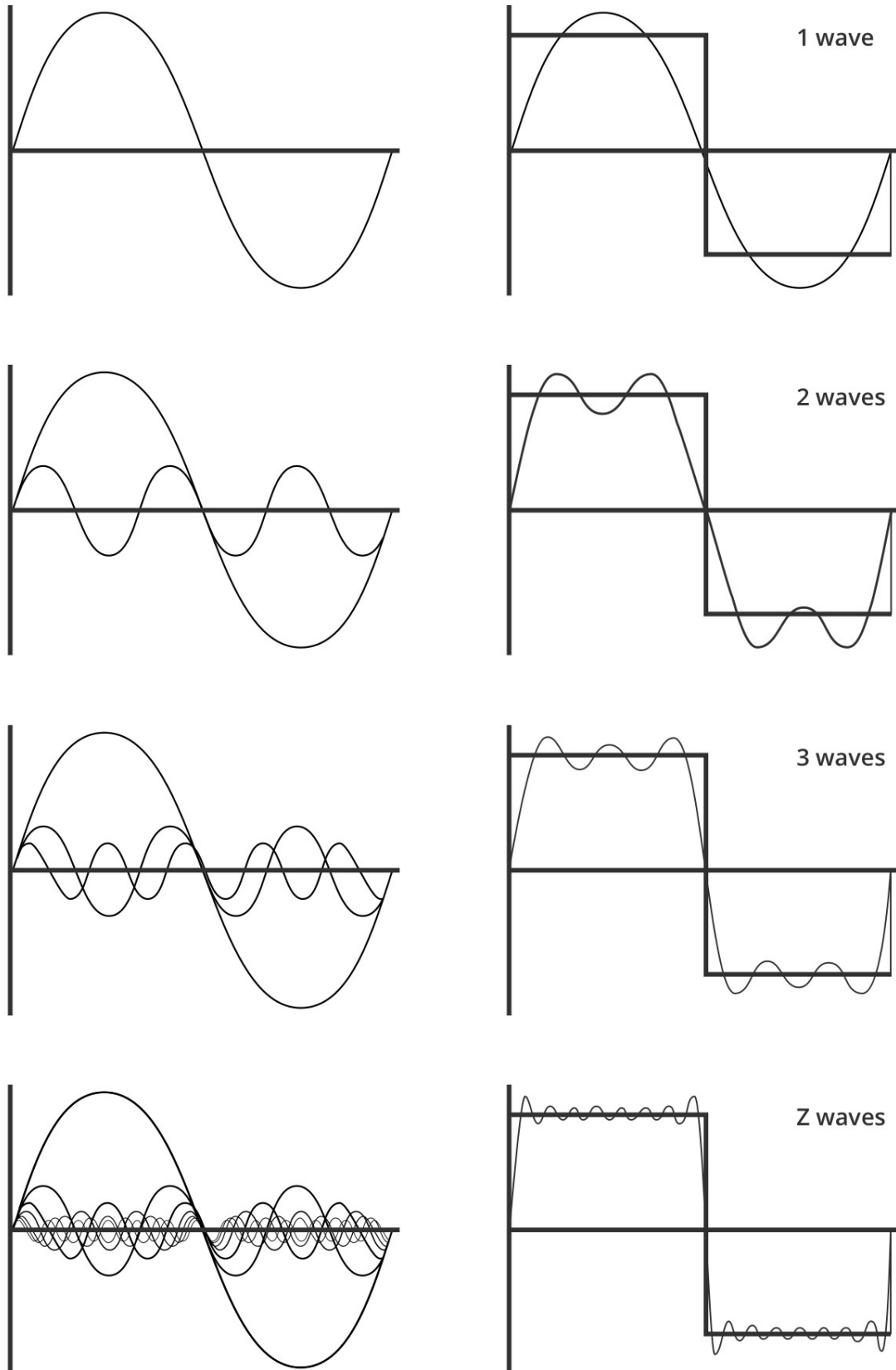
At a very fundamental level, a Fourier transform, converts the original data into a series of waves (usually sine waves) that, when added together, reproduce the original function. The series of waves is known as a Fourier series, the mathematical operation that derives the components of the **Fourier series** is known as a **Fourier transformation** and the process of summing them together is known as **Fourier synthesis**.

A wide range of natural phenomena result from the combination of many waves with distinct mathematical properties. For example, white light is composed of the different wavelengths across the visible spectrum. Mathematically, the combined waveform is described as a convolution. To do the reverse is to 'deconvolute' what we observed. This is what happens when a glass prism separates out the different wavelengths to produce a rainbow. The same separation, or deconvolution, can be achieved mathematically by performing a Fourier transformation. It can be thought of as the mathematical equivalent of using a prism to separate the different colours of the rainbow.

In performing a Fourier transformation on the data, the observed signal is converted into a different representation of the same information.

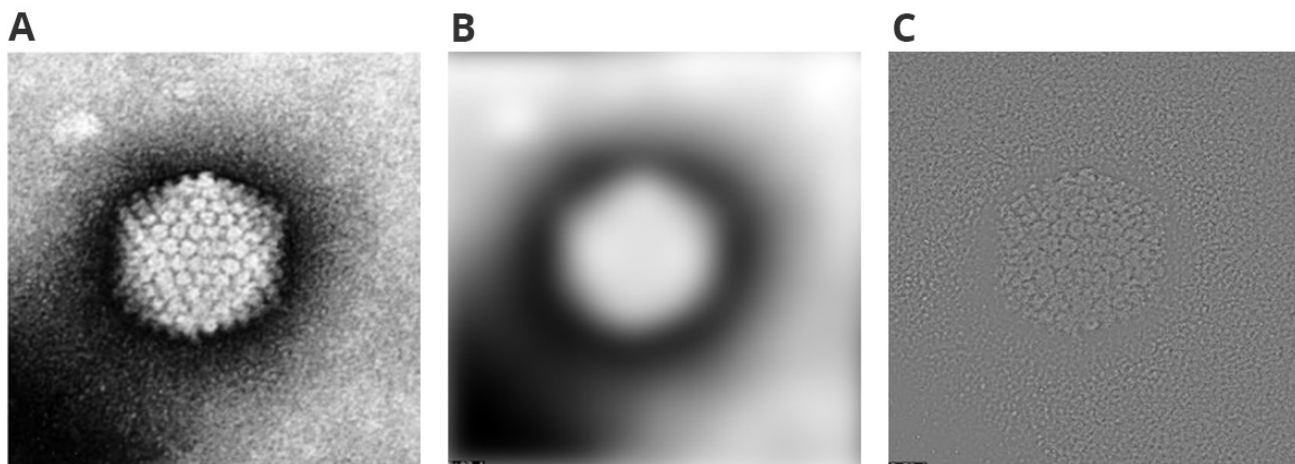
# Fourier transforms in cryo-TEM image processing

In understanding Fourier transformation, it is important to note that you can rewrite any function as a **Fourier Series**. A step function is often considered as being the most difficult signal to reconstruct in this way, since step functions have sharp edges, and sine waves do not. However, as can be seen in the example below, it can be done as the wavelength of the shortest wave used in the sum approaches an infinitely small number.



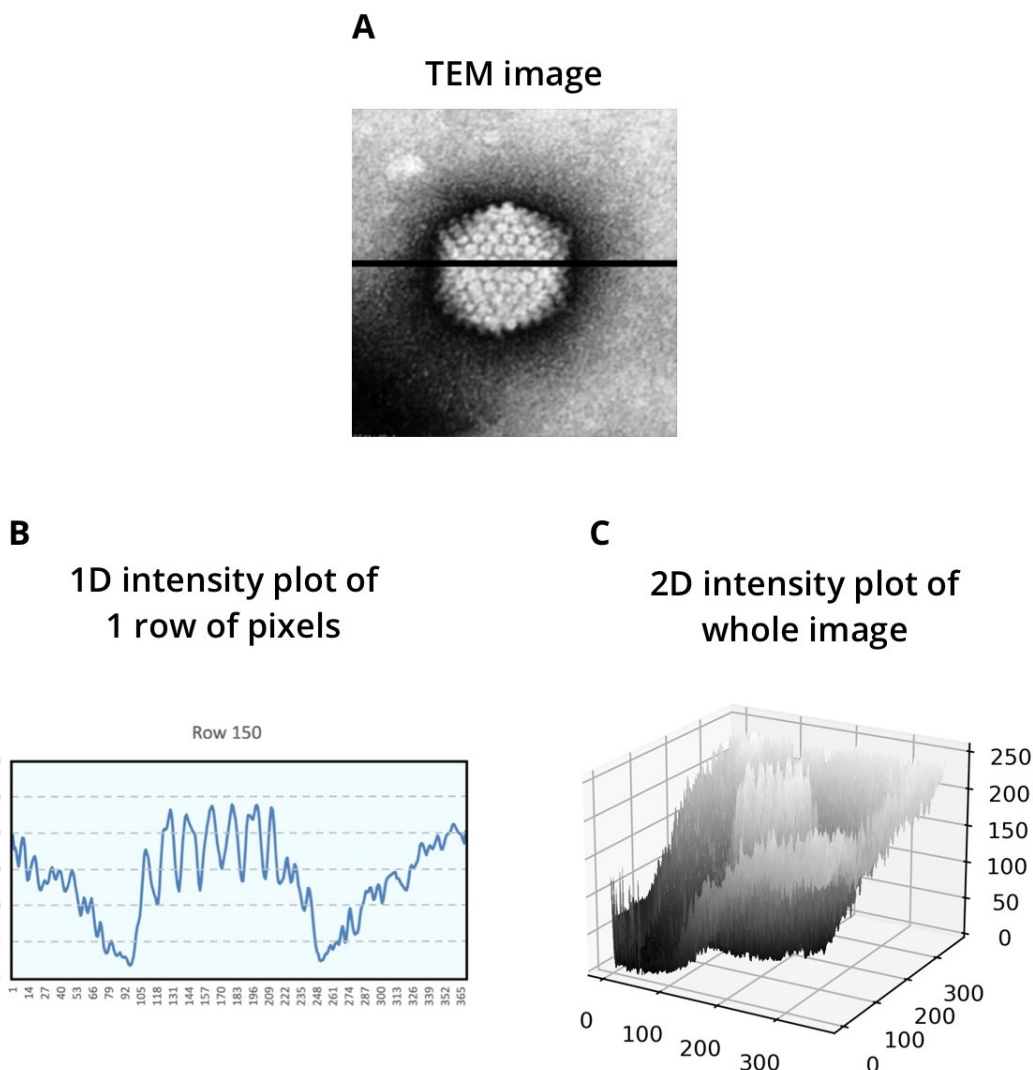
Cryo-EM images can also be represented as mathematical functions. Effectively, a cryo-TEM image is a 2-dimensional

matrix of pixel intensity values. Where there is a big difference in the intensity between one pixel and its neighbour, the shape of the plot will change sharply (such as when going from black to white). Where there are many adjacent pixels of similar intensity, the plot will change gradually. These relationships between pixel intensity across the image, shape the plot and reveal resolution. In other words, high resolution features, such as those in the centre of the viral capsid proteins in the figure below, are described by changes in intensity over a very small number of pixels, while low resolution features such as the overall shape of the virus particle are described by many pixels. Highly detailed information is described as being high spatial frequency information and the less detailed information is described as low spatial frequency information. You can see these separated out in the figure below.



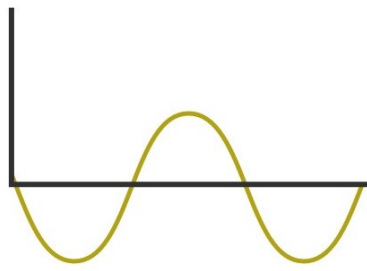
A. Electron micrograph of a negatively stained viral particle. B. The same image using only the low resolution or low spatial frequency information. C. The image when only the detailed high resolution or high spatial frequency information is used. Images courtesy of Michael Landsberg, University of Queensland.

By taking a single line through this image and representing it as a function, we show that it is possible to deconvolute even a non-periodic function into a Fourier series.

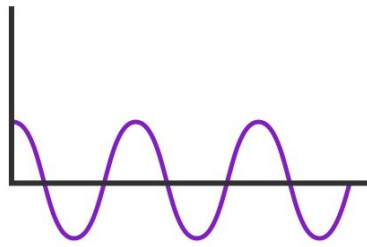




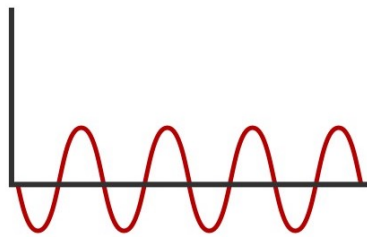
Deconstructed into a series of 1D sine waves



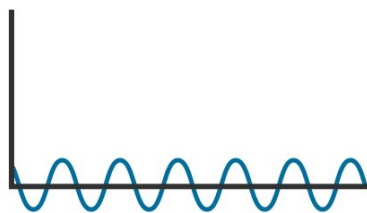
+



+



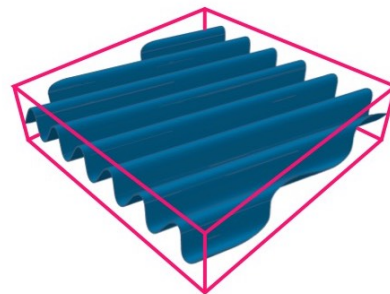
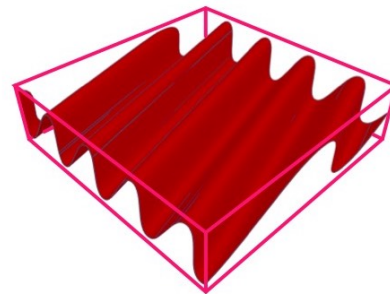
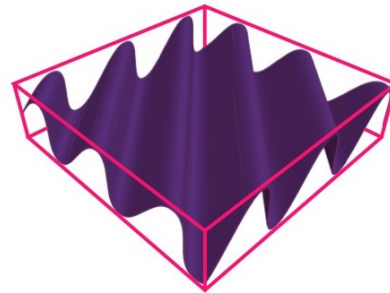
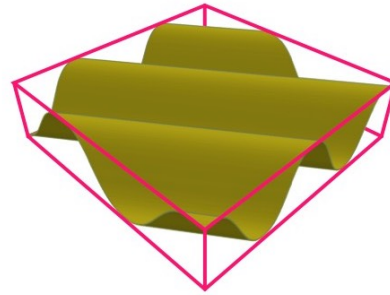
+



+

More and more  
1D sine waves

Deconstructed into 2D  
sine waves running in all  
directions across image



Fourier transform is the  
sum of all the sine waves  
needed to generate the  
shape of the 2D plot

*Schematic illustration showing the process of Fourier transformation of a TEM image.*

- A. The starting image with the line showing the row of pixels whose intensity is plotted in b.*
- B. To illustrate the concept of Fourier transformation, the intensity of each pixel along the line shown in a. is plotted. The shape of this plot can be deconstructed into a series of 1D sine waves that when added together regenerate the shape of the plot.*
- C. To do a Fourier transform on the whole image, you can understand it by visualising a 2D intensity plot of every pixel in the image. This is then deconstructed into a series of 2D sine waves oriented in all directions across the image to generate all the peaks and troughs of the 2D intensity plot. The combination of sine waves shows the relationship of pixels and their intensities to the surrounding pixels. The sum of all the sine waves across the image is the Fourier transform and gives information about the spatial frequencies in the image.*

If we consider the relationship between the components of our Fourier series and our original cryo-TEM image, we can see that short wavelength (high frequency) functions are needed to describe rapid changes in pixel intensity while functions with a longer wavelength (lower frequency) describe gradual changes. Therefore, the high frequency waves are necessary to describe high resolution (small) features of the image, and the low frequency waves are necessary to describe low resolution features. The use of frequency in this context is always referred to as spatial frequency.

For the single line through the 2D image shown above, it is possible to calculate and represent the Fourier transform as a complex series of simple waves, as we have done above. However, for an entire, large 2D image (and indeed for a 3D volume), calculating and visualising Fourier transforms quickly becomes an exceedingly difficult task. Moreover, the Fourier transformation itself involves the complex number  $i$  ( $\sqrt{-1}$ ), and so when a function composed entirely of real numbers (e.g. a cryo-TEM image) is subject to Fourier transformation, the result will be a series of complex numbers.

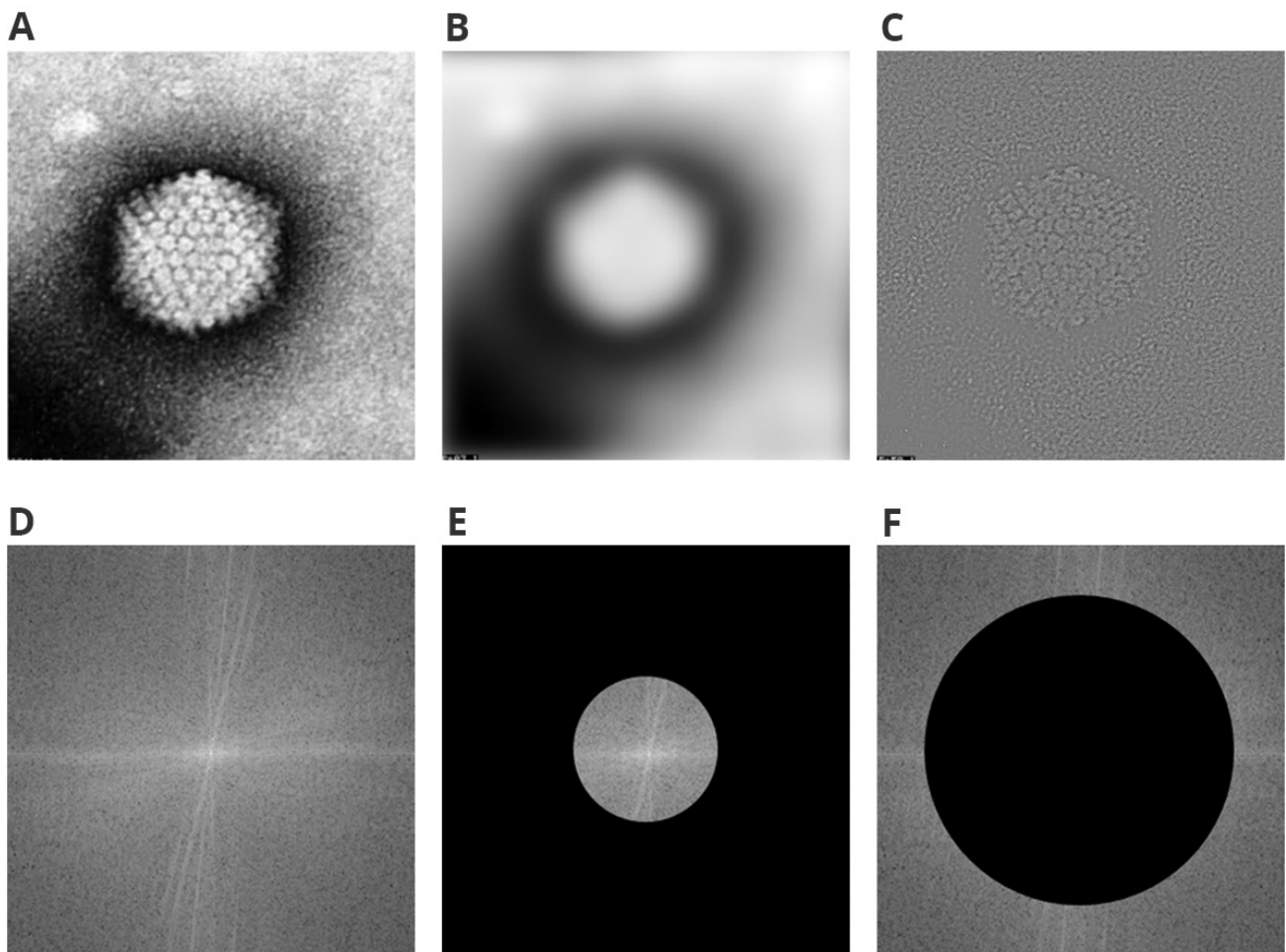
So how do we visualise Fourier transforms of cryo-EM images, and what can they tell us?

# The power spectrum

To make it possible to visualise the information in the Fourier transform we can display it as an image, but to do this we first need to process it to remove the complex numbers. The easiest way to do this is by squaring all of the values in the Fourier transform. This results in a representation referred to as a power spectrum.

The images below show the power spectrum of the virus particle image we looked at above.

Visually, the power spectrum appears to have no obvious correspondence with the image it is derived from. However, like the Fourier transform, it deconvolutes the image according to spatial frequency. Each data point in the Fourier transform contains information that defines a wave function with a given frequency and amplitude. Combining all of these waves together will reproduce the original image. Note however, that the power spectrum does not show us the phase information although this is contained in the Fourier transform.



*Images courtesy of Michael Landsberg, University of Queensland.*

The power spectrum is a radial plot with the origin at the centre. Low spatial frequency information is located closer to the origin and high spatial frequency information towards the edge. In B and E of the figure above, all the high frequency information has been removed and only the low spatial frequency information is retained. In cryo-TEM image processing this is equivalent to applying a **low pass filter** and produces the low-resolution image shown in B. Similarly, in C and F only the high spatial frequency information is kept.

# Why do we even need to look at the power spectrum?

---

While it may initially not seem very useful to visualise the Fourier transform as a power spectrum of an image, its importance lies in what it reveals about the artefacts and aberrations that accumulated during cryo-EM image capture. These affect the data in a way that depends on spatial frequency, i.e. they have a greater impact on the higher resolution information in the image. For example:

1. There is a general fall off in the quality of data obtained at exceedingly high resolutions. This can be described by the so-called envelope function.
2. The contrast transfer function introduces alterations to the data when images are recorded at the defocus values typically needed to obtain sufficient contrast in cryo-TEM images for SPA.

Other undesirable effects such as the level of astigmatism, or drift associated with an image, as well as crystalline ice contamination, are often more clearly diagnosed in the power spectrum than in the cryo-TEM image itself.

Displaying the data as a power spectrum therefore makes it easier to analyse the potential of the image to provide high-resolution data for reconstruction.

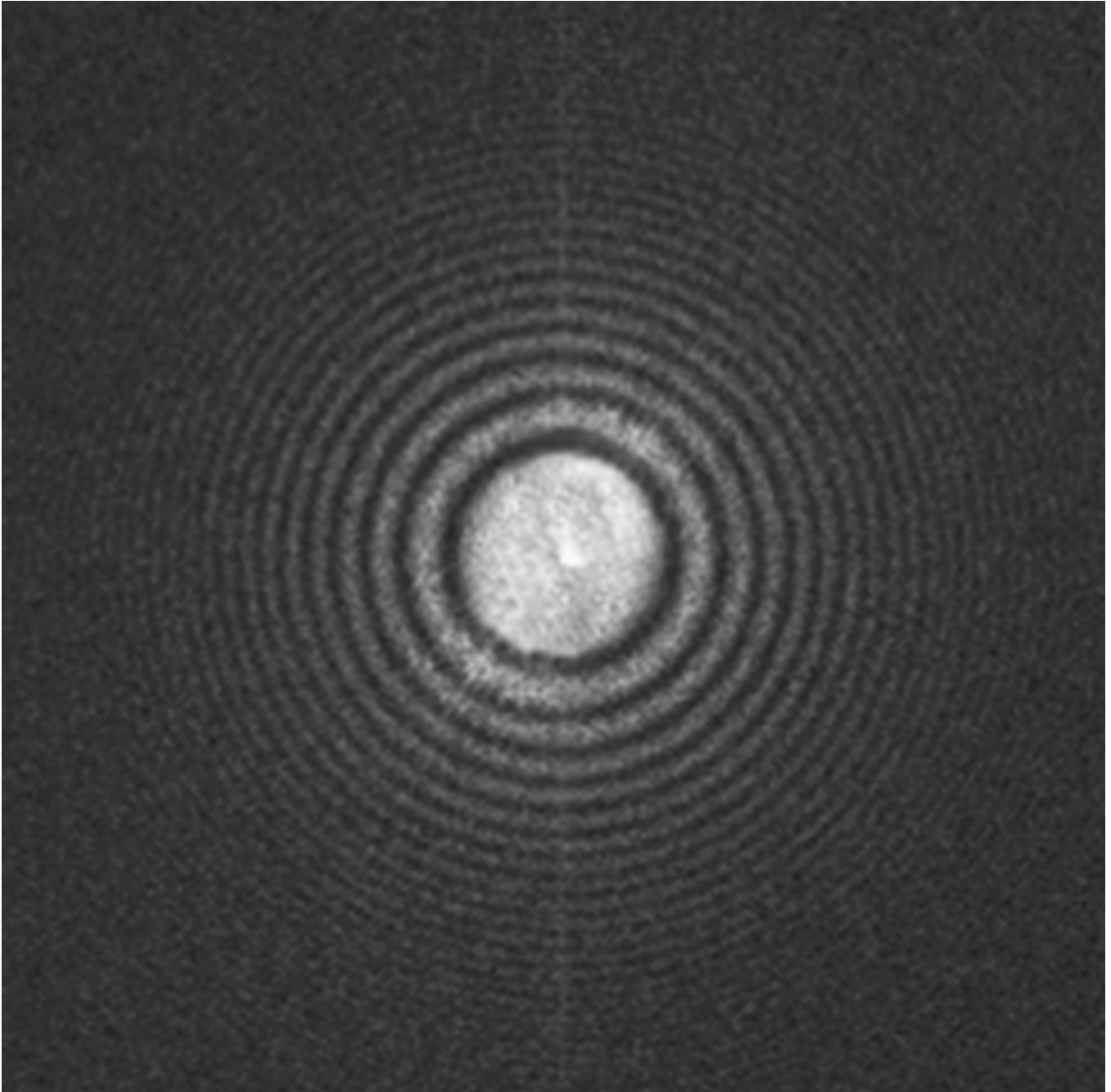
Some of the artefacts indicate that the images should be discarded, but others can be corrected during image processing, including the effect of the contrast transfer function. This is discussed in the next section.

It is worth noting that although the power spectrum is the square of the Fourier transform used for display purposes, you may sometimes see the power spectrum called the Fourier transform. This is a form of shorthand sometimes used by people in the field and should not confuse your understanding of the difference.

# Contrast transfer function

---

Recall that defocus is required to generate contrast in phase contrast imaging, and that phase contrast is the dominant source of contrast in cryo-TEM images. The power spectra of cryo-TEM images collected using a higher level of defocus often exhibits a pattern of concentric circles, called Thon rings. The intensity of the Thon rings varies depending on the nature of the material being imaged; e.g. continuous carbon will give stronger Thon rings than amorphous ice, and provided the specimen is sufficiently stable, the Thon rings will become clearer with longer exposures. The position of the Thon rings also depends on the optical parameters of the microscope including defocus and astigmatism. Recall also that in the power spectrum, information towards the centre of the image is low-resolution information, and towards the edge of the information is the high-resolution information. Therefore, in a well aligned microscope (i.e. where the Thon rings are perfectly circular), the effect of the contrast transfer function (CTF) is uniform for a given spatial frequency (or resolution).



*An example of a power spectrum from an image taken using defocus showing the obvious Thon rings. Image courtesy of Lou Brillault, University of Queensland.*

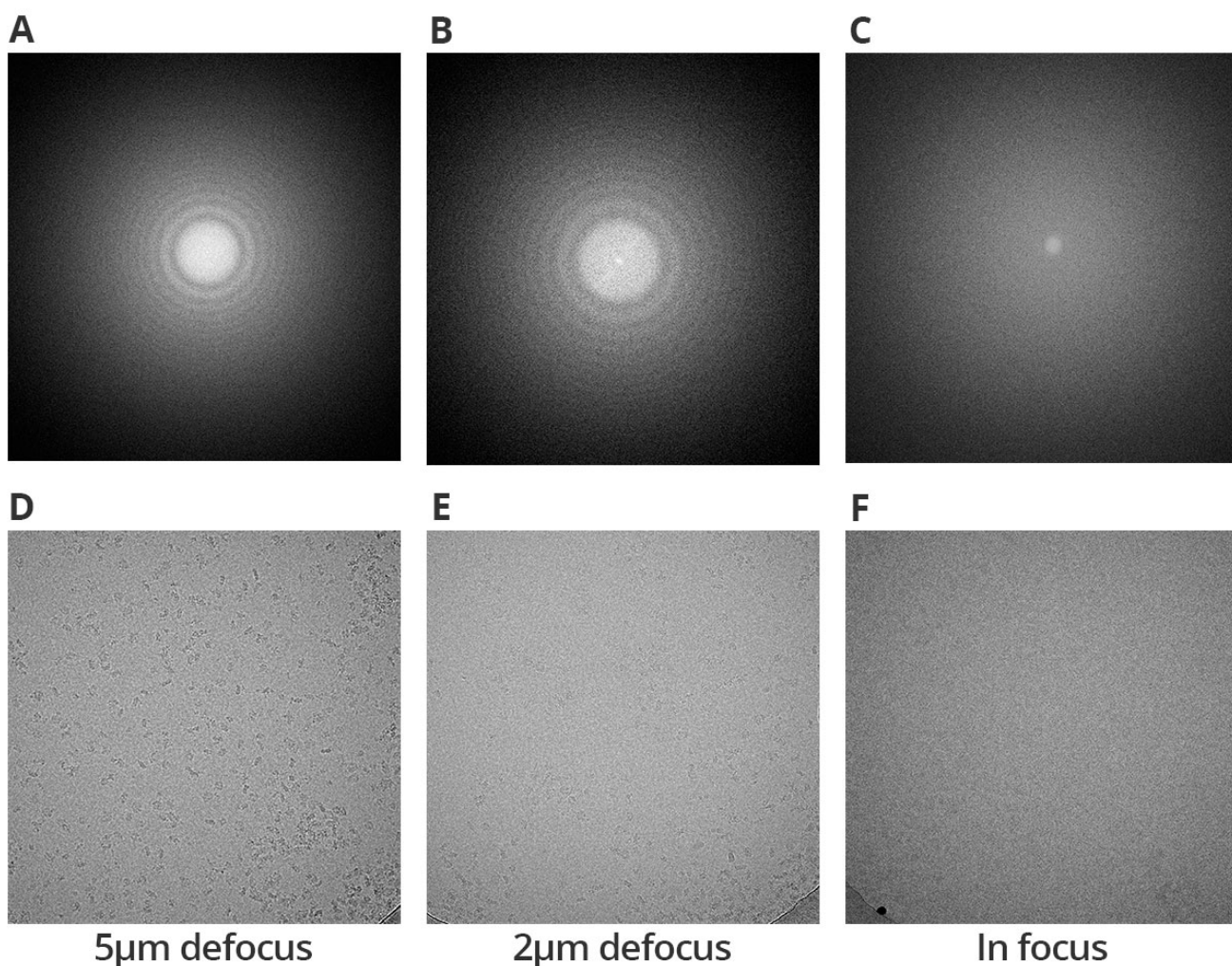
You will remember from the How Images are Formed section that in phase-contrast imaging, waves scattered by the sample and then focussed by the objective, will travel different distances as they arrive at the detector. They will therefore undergo differing amounts of phase shift relative to each other. When waves are out of phase they can

enhance or cancel each other out to some extent. This means that some of the information about the sample is strongly represented in the image and some is reduced or absent altogether. This interference is particularly pronounced when defocus is used to generate contrast.

The Contrast Transfer Function (CTF) is a measure of how much the phase shift and microscope aberrations have corrupted the image. This function describes how much contrast is recorded in the image for a given feature in the sample. Describing the CTF allows us to correct for this corruption and get back the true information.

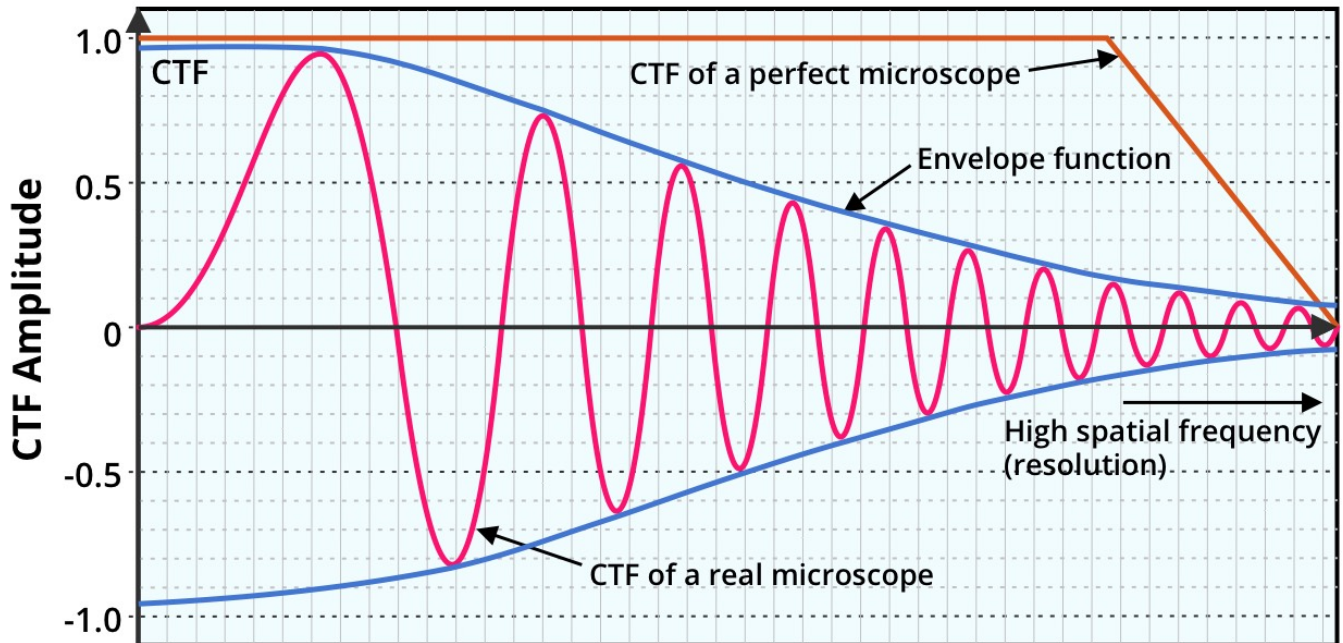
Because the amount of defocus and aberrations in the microscope are known, their effect can be calculated and compensated for to obtain the maximum amount of true high-resolution information about the original sample.

If we consider a true image of the sample – one that is not corrupted by the CTF or other aberrations – we would not expect to see Thon rings in the power spectrum. Rather, there would be a continuous distribution of information throughout the power spectrum, with fluctuations in the intensity of the data points that reflect only the underlying structural features of the sample. In perfectly focussed samples the power spectrum is closer to this ideal, although there is still some fall off in the average intensity of the data points at high spatial frequencies. This fall off is separately described as representing the envelope function of the imaging system. Combining the theoretical CTF with the envelope function gives us a picture of the effective CTF.



*Images and their corresponding power spectra for images taken at 5mm (A and D), 2mm (B and E) and in focus (C and F). The particles are more readily obvious at the higher defocus and almost invisible in the in focus image. In the power spectrum for the 5mm defocus the Thon rings start closer to the centre and do not extend as far out into the higher spatial frequencies. The opposite is true for the 2mm defocus power spectrum. In the in focus power spectrum no Thon rings are visible. Images courtesy of Juanfang Ruan, University of New South Wales.*

This CTF can be represented by a plot that corresponds to a line through the power spectrum from the centre to the edge. The shape of the plot shows how much the microscope aberrations and defocus have degraded the signal reaching the detector and therefore reveals the quality of the information (peak height) you can get from the image at increasing spatial frequencies (increasing resolution). For the perfect microscope operated at focus the CTF would be 1.



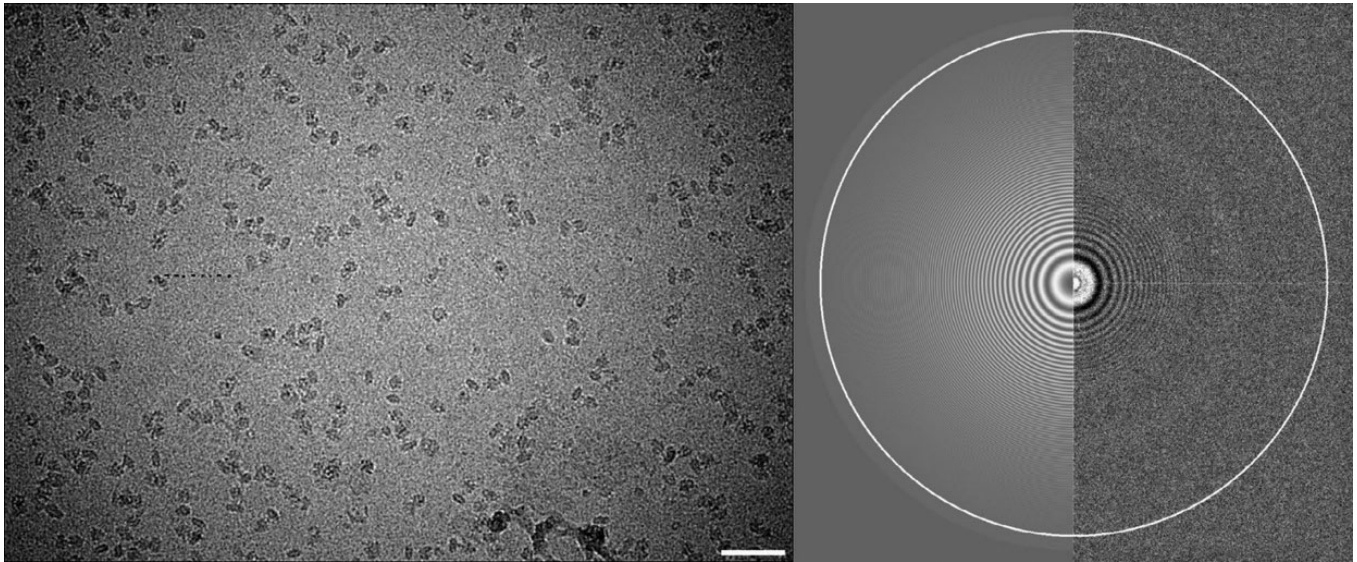
A CTF plot.

However, for the real microscope using defocus, the CTF fluctuates between alternating positive and negative maxima, corresponding to positive and negative contrast transferred to the image. The zero-crossings indicate frequencies where no information has been captured. The negative values indicate useful information but where the signal has become inverted. These negative values can be made positive by phase flipping. This is done by simply multiplying the Fourier transform by  $-1$  over the appropriate frequency ranges. This serves to correct aspects of the phase contrast effects in the image.

The information missing from the CTF, as indicated by the zero-crossings, cannot be retrieved from the single image represented in a given power spectrum. However, as you will learn later on cryo-EM reconstructions are obtained by averaging together many thousands or even millions of particle images. By recording images at different defocus settings, the information loss will be spread out. So that the different spatial frequencies that are absent from different images are recovered by combining information from many different images.

Limitations of the microscope also contribute to the CTF. These factors are called envelope functions and dampen the CTF at high spatial frequencies (high resolution). This is visualised by the decreasing height of the peaks at higher resolution. The limit to which the high spatial frequencies (outer rings) can be seen in the power spectrum indicates the maximum resolution that can be obtained from a given image. This maximum resolution is called the Nyquist limit.

You can calculate the theoretical optimal CTF of the microscope for the conditions you used. You can then compare it to the CTF for the actual data you collected. Those images that show poor correlation to the shape and resolution limit of the theoretical CTF can be discarded.



Representative image from a dataset taken of *E.coli* ATP synthase particles. The corresponding CTF showing a comparison of a theoretical CTF with the real CTF for the image. Scalebar is 50nm. Images courtesy of Alastair Stewart, Victor Chang Cardiac Research Institute.

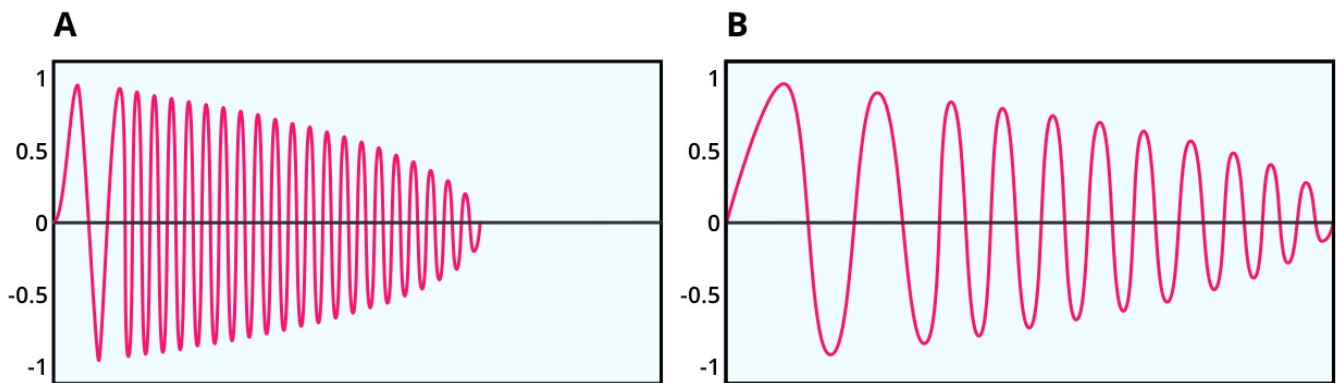
As the CTF is directly related to defocus, typical plots show the following:

With high defocus (more phase contrast in the images)

- There are frequent zero crossings indicating substantial loss of information
- The initial maxima are at low spatial frequency indicating that you get better information at lower spatial frequencies (low resolution)
- A better signal at low frequency means high contrast images
- More high frequency information is lost at high defocus

With low defocus (less phase contrast in images)

- There are fewer zero crossings indicating that high resolution information is better preserved
- Initial maxima are at higher frequencies
- This causes the features in the images to show low contrast, which may not be visible to the naked eye



Comparison of a CTF for an image with a A. high defocus and a B. low defocus. With high defocus there are many zero crossings, the initial maxima is at low frequency. In the low defocus CTF There are fewer zero crossings, the initial maxima is at higher frequency and more high frequency information is preserved.

The CTF can be empirically determined using the formula below:

$$CTF(f) = E(f) \sin(\pi C_s \lambda^3 f^4 / 2 - \pi \lambda d f^2)$$

where  $C_s$  is a spherical aberration of microscope;  $\lambda$  is the electron wavelength from the voltage;  $f$  is spatial frequency,  $d$



is the applied defocus (negative for defocus), and  $E(f)$  is the envelope function. Thus, it can be seen that the value of the CTF can be theoretically approximated if all of the other components of the equation are known. For a given microscope operated at a fixed voltage, the  $C_s$  and wavelength ( $\lambda$ ) are known. The nominal defocus is usually known for a given image but is usually fine-tuned based on the position of the zero crossings (this is actually how the autofocus function of the data acquisition software on your microscope works). The envelope function is approximated from the damping of the maximum peak heights in the CTF

If we assume that the image recorded by an electron microscope is a CTF-corrupted image, we can recover the true image by modelling the CTF and then removing it from the image by inverse multiplication. This generates the corrected Fourier transform, which can then be inverted to generate the corrected image.

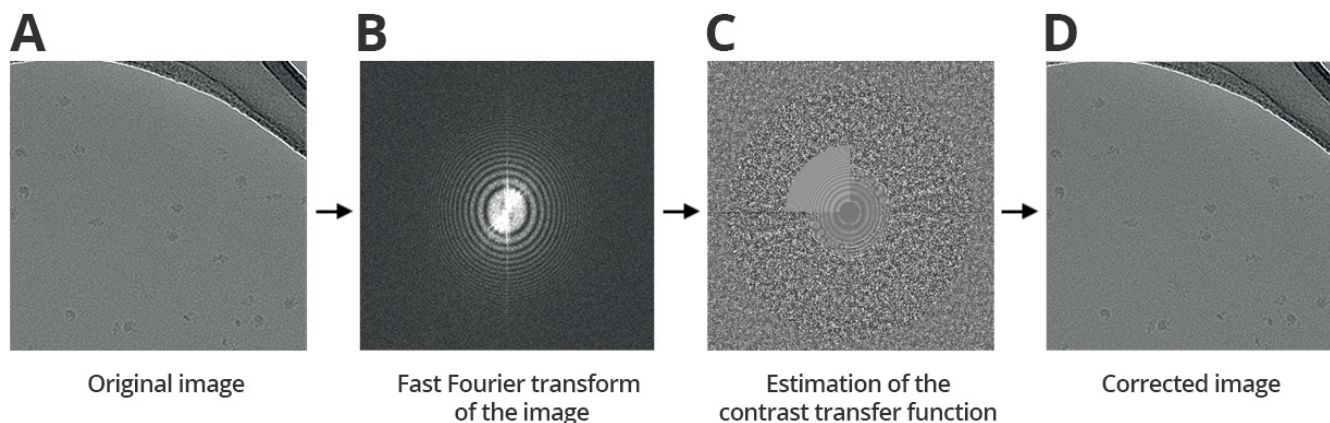


Figure showing the process of CTF correction. A Fourier transform is performed then an estimation of the CTF is calculated. Then a CTF correction can be applied to restore the correct information to the original image. The CTF here is shown as its power spectrum. It's compared against a theoretical CTF in the top left-hand quadrant to confirm its accuracy. Images courtesy of Lou Brillault, University of Queensland.

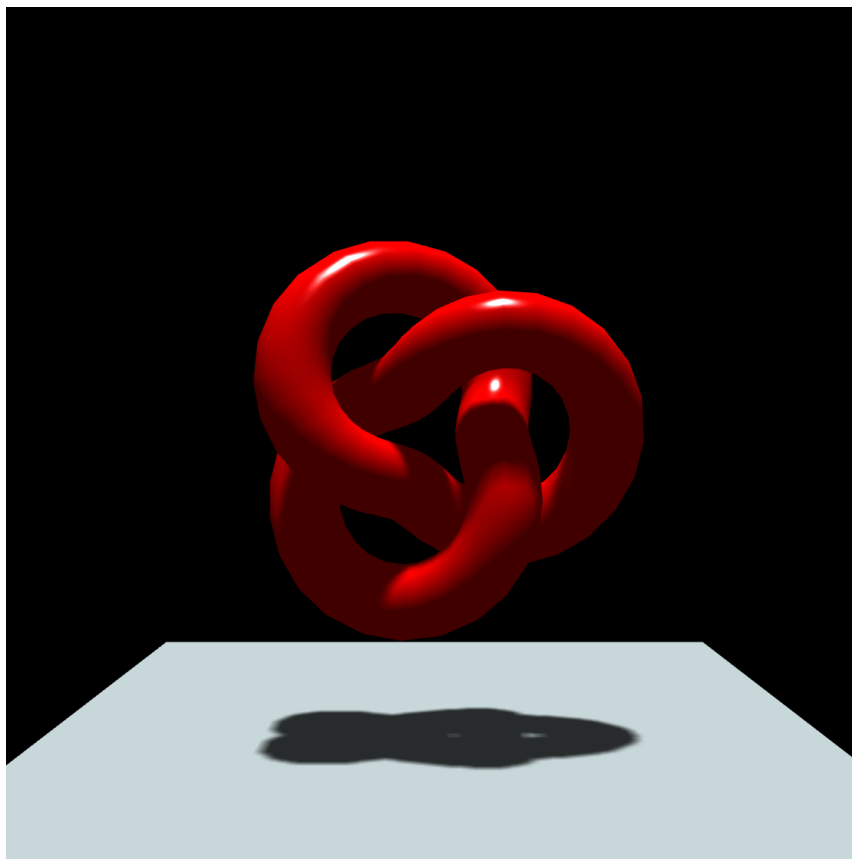
# Single particle analysis – Introducing Single Particle Analysis

---

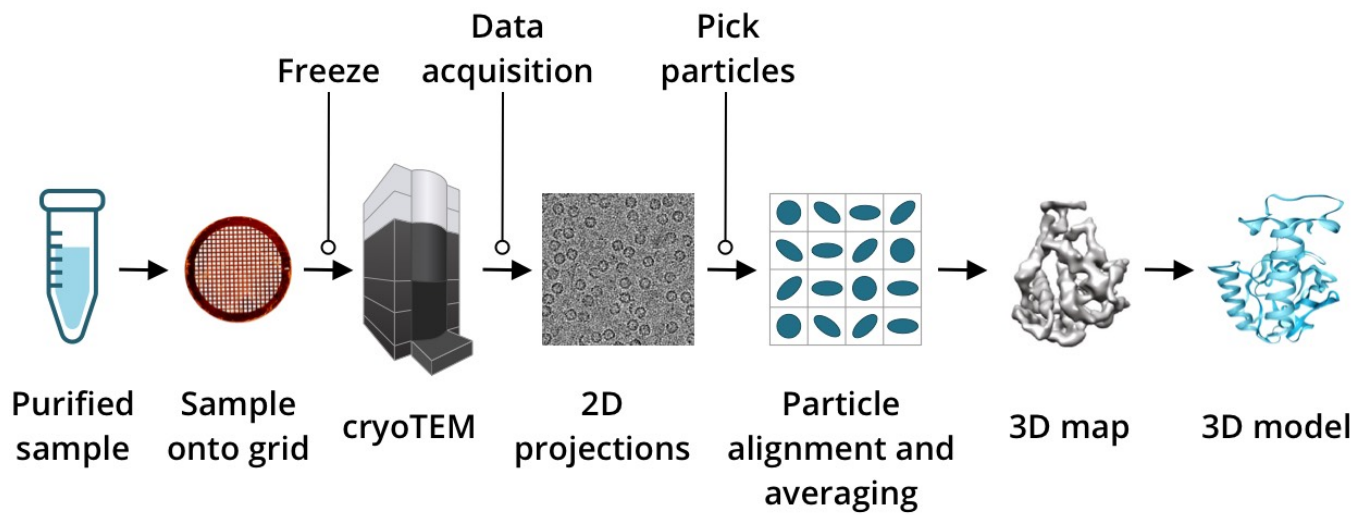
Structural biology is a branch of molecular biology, biochemistry and biophysics that relates to understanding the structure of macromolecules. In the past, X-ray crystallography was the technique used to produce high-resolution 3D models of macromolecules, but more recently with the technical advances of cryo-TEM the field of single particle analysis (SPA) is now at the forefront of structural biology. This term “particle” is used to refer to the individual biological macromolecules or complexes. Determining structures at 3Å resolution is now almost routine but an increasing number of structures of 2Å or better are reported.

The iterative improvement in electron microscopes and detectors plus more powerful computational tools has led to what has been called the “Resolution Revolution”. In 2017 the Nobel Prize for Chemistry was awarded to Jacques Dubochet, Joachim Frank and Richard Henderson for “Developing cryo-electron microscopy for the high-resolution structure determination of biomolecules in solution.

Basically, the purified macromolecules are frozen in a thin layer of vitreous ice and then observed in a cryo-TEM. Images of tens of thousands of particles are taken at very low electron dose. The rationale behind this approach is that the particles will lie in different orientations within the vitreous ice. These different orientations will lead to many different shapes being captured on the TEM image as the beam passes through the sample. Via computational analysis, these multiple images are reconstructed into the high-resolution 3D maps of the particle in question.

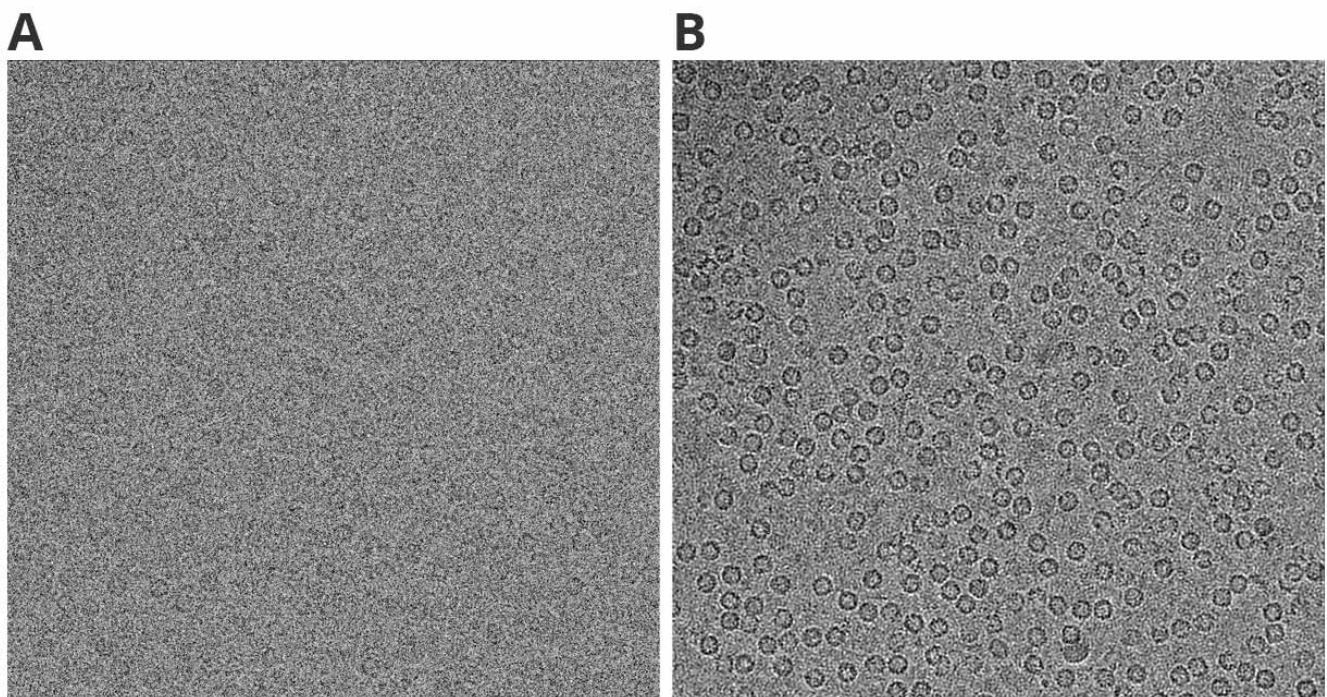


*This illustrates how the orientation affects the shape of the particles in the TEM image. Courtesy of Martyn Cook.*

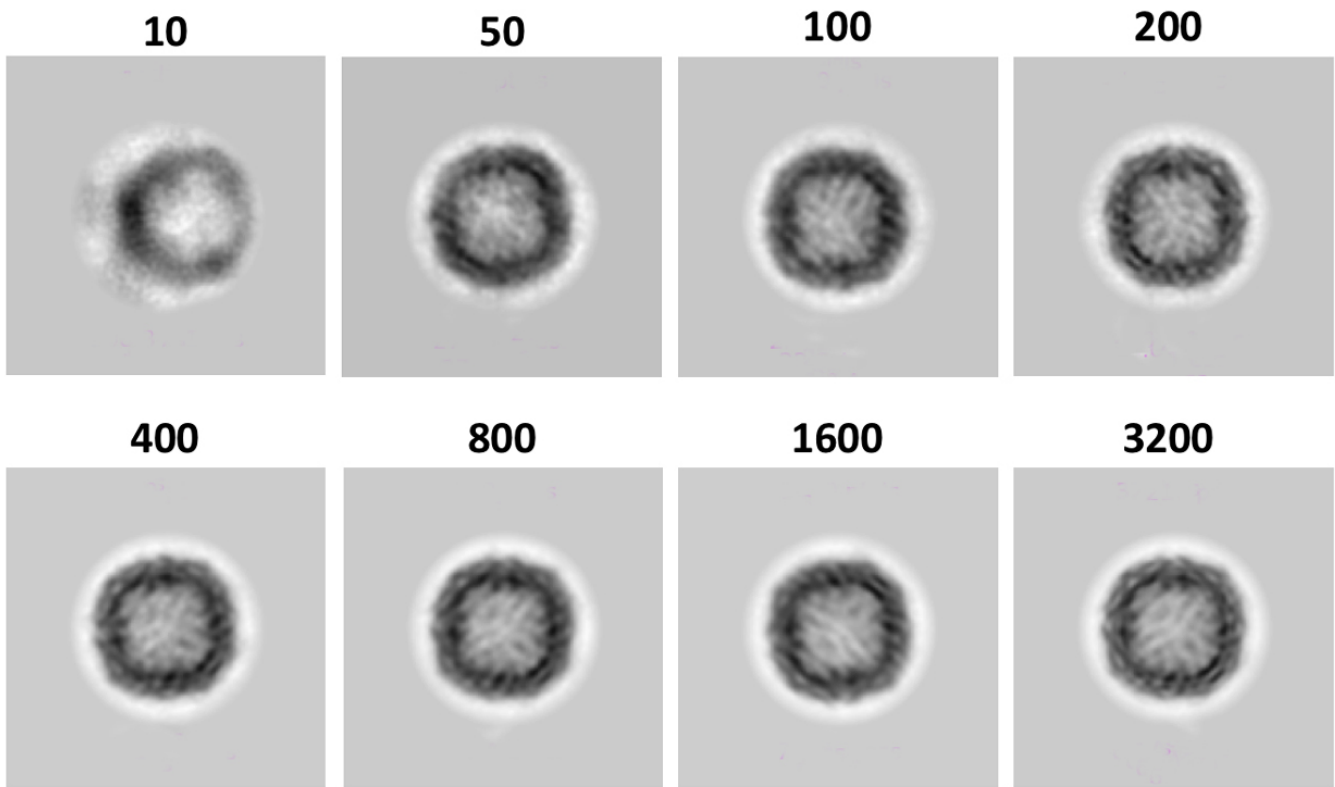


Workflow for single particle analysis

Even using ideal imaging parameters, individual electron microscope images do not contain sufficient information to provide an atomic description. To limit radiation damage to the sample the images are collected at low electron doses which are inherently noisy. To work around this, many images are collected and averaged. If identical noisy images can be grouped and averaged, the high-resolution signal in the images adds coherently, while noise is gradually averaged out.



Cryo-EM images of GroEL particles. A. Raw image captured without the use of an energy filter showing how much noise is in the image and how difficult it is to see the actual particles. This is averaged and motion corrected from the original movie. B. A low pass filter has been used on the image in A. to show the particles. Images courtesy of Nick Ariotti, UNSW.

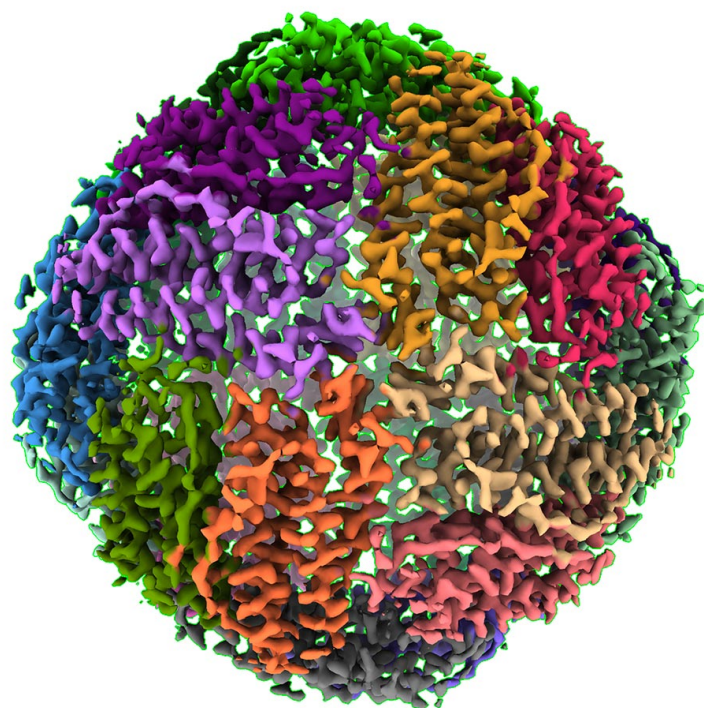


The detail in an image obtained in cryo-TEM is low and the noise is high. By averaging many similar images together the signal is increased and the noise reduced as can be seen here by averaging together 10, 50, 100, 200, 400, 800, 1600 and 3200 images of different particles. Images courtesy of Hari Venugopal, Monash University.

The word 'resolution' in cryo-EM refers to how trustworthy various features are in the 3D reconstruction map of the macromolecule, based on the ratio of signal intensity to noise intensity at a particular position.

SPA is based on several initial assumptions.

1. All particles in the specimen have identical structure
2. All particles undergo 3D rigid body transformations (rotations, translations)
3. Particle images are interpreted as the projection of the common structure plus noise.

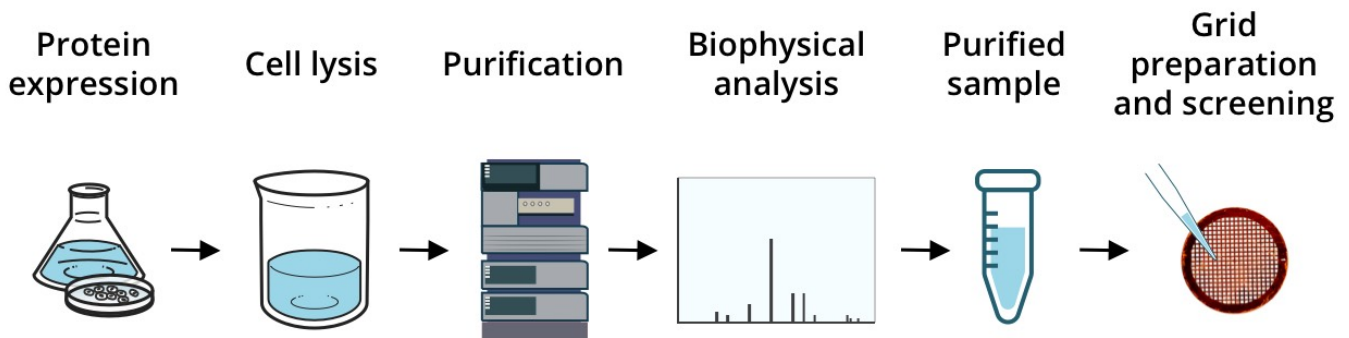


Structure of apoferritin solved using single particle analysis. Image courtesy of Nick Ariotti, University of New South Wales.

# Biochemical preparation and stabilisation

High resolution reconstructions are only possible if the process starts with an ideal sample. So, sample preparation is crucial to the whole process and as much time must be donated to this as any other stage of the operation. This involves the expression of the protein or protein complex of interest, its purification and biophysical analysis.

Having a monodisperse preparation with particles of approximately the same mass, shape and size is essential before starting a study of this type. Size exclusion chromatography can be a good gauge of the monodispersity of the sample, showing if there are aggregates or even dissociated complexes present. Protein stability, integrity and activity should be verified by various biophysical techniques and sample concentration is adjusted before EM grid preparation.



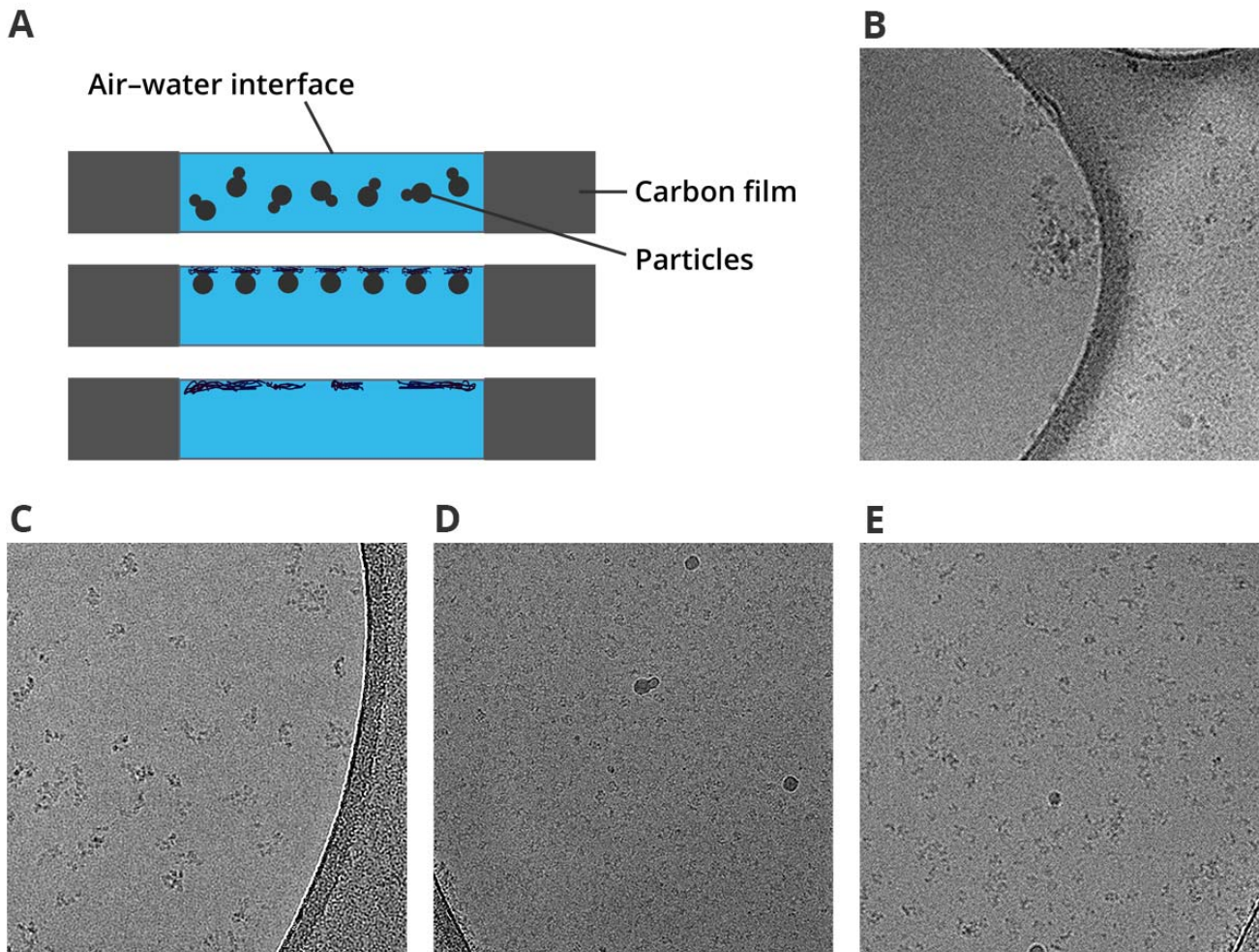
*Protein purification workflow. Proteins of interest are expressed in cell cultures and different cell disruption methods are utilized for releasing cytoplasmic proteins into solution or to obtain cell membrane extracts. The proteins are purified via techniques like liquid chromatography. Protein stability, integrity and activity is verified by various biophysical techniques to ensure the samples are ready for electron microscopy screening*

## Stabilisation of the sample

Instability of the particles can cause denaturation or aggregation of particles or preferential orientations to occur in the preparation. The physiological conditions under which a macromolecule is prepared and stored have an important impact on its stability, so even the suspension buffer can be critical. Many different conditions should be trialled for their effects.

On occasions it may necessary to stabilise the protein to avoid conformational variability. This can include addition of a particular molecule that binds to the particle to maintain structural conformation. A range of different solutions have been used for this purpose, including Fab antibody fragments. Of course, the added molecule is now part of the structure to be considered during analysis.

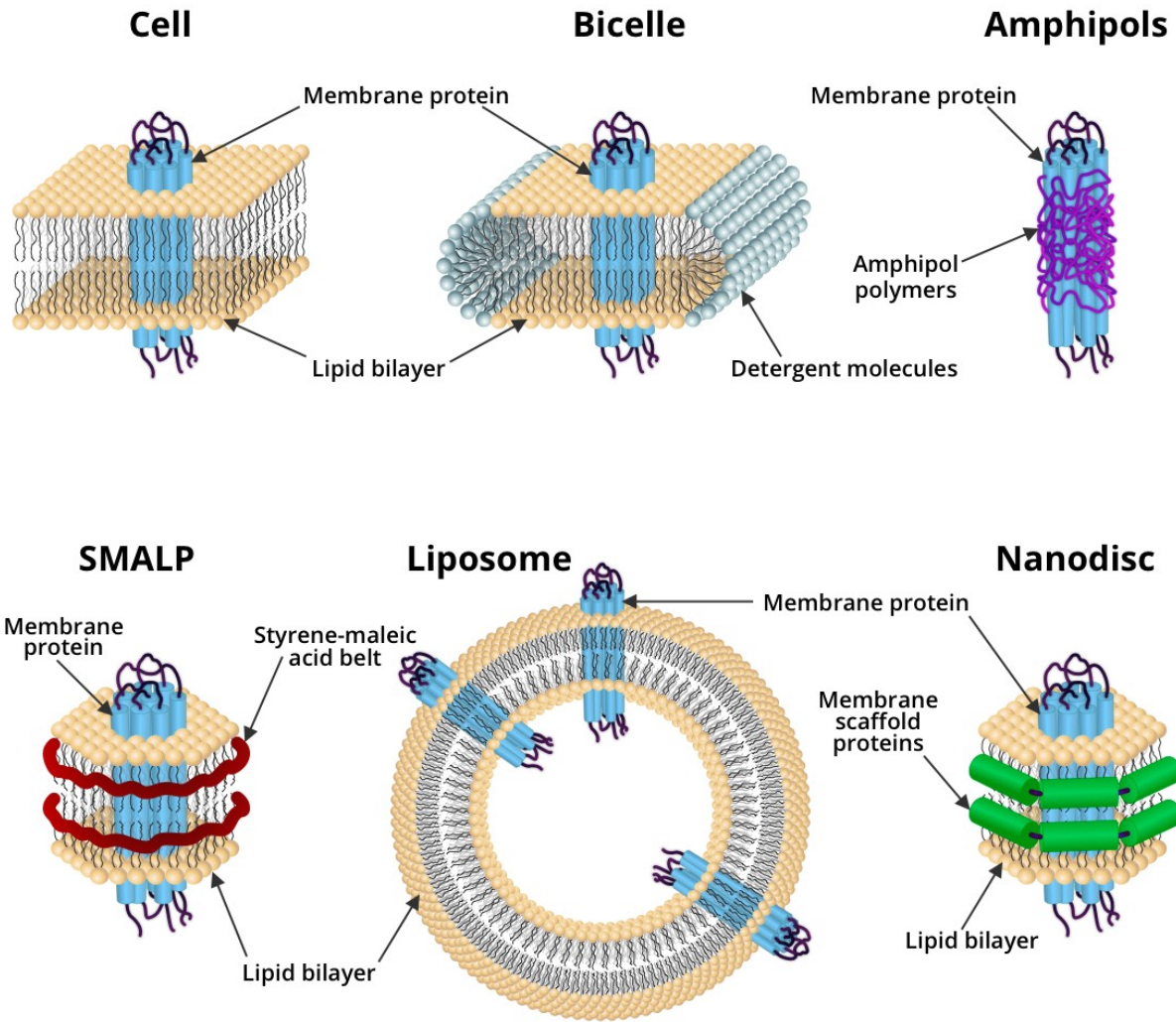
Chemical crosslinking of the proteins and protein complexes of interest can also provide more stability by covalently bonding closely associated regions of the protein, thus preventing denaturation. However, this should be done with care to ensure that it doesn't in itself introduce structural artefacts. Glutaraldehyde in low concentrations is often used for this purpose. Ultracentrifugation of the sample through a gradient containing increasing concentrations of the cross-linking agent allows doing this in a more controlled manner as the bands on the gradient should contain a homogeneous population of particles. This process, known as GraFix, largely prevents intermolecular crosslinks and favours intramolecular ones.



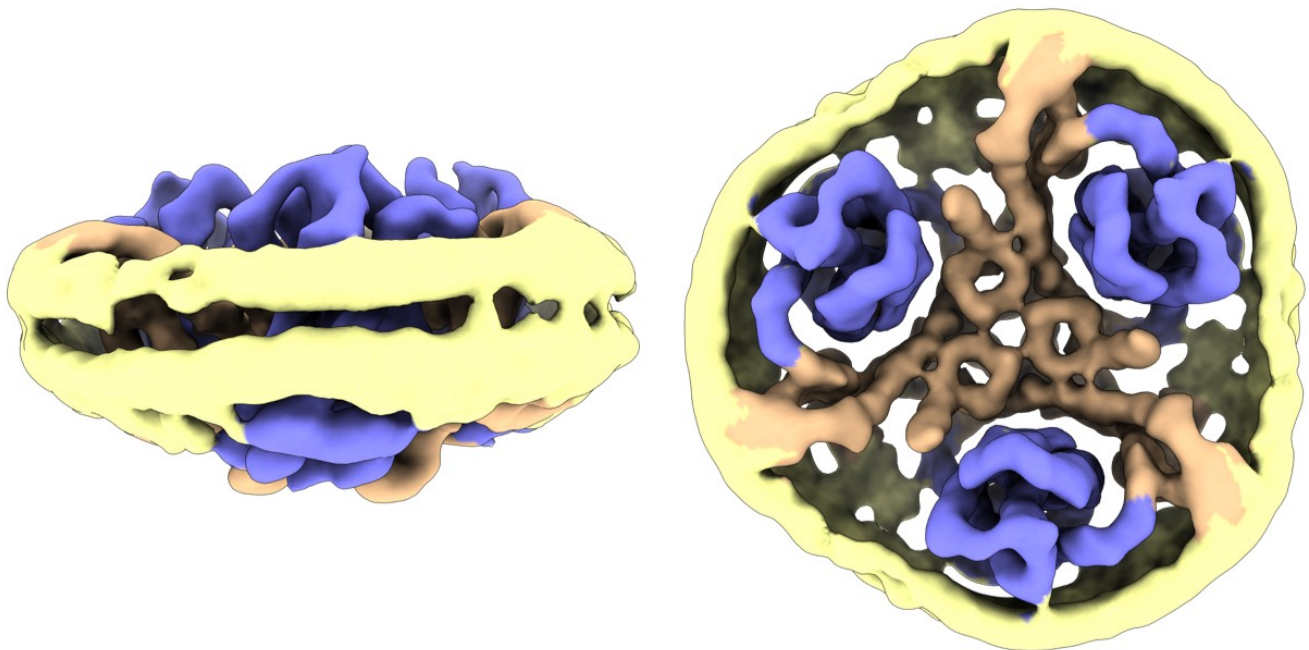
*Examples of different methods to stabilise particles. A. In some cases during freezing of proteins on a grid they rapidly move to the air-water interface. B. An example of this phenomenon leading to aggregation. C. the use of cross-linking with glutaraldehyde, helps an unstable oligomer to not unfold at the air-water interface. D. The use of different buffer conditions and different salt concentrations can also help to stabilise the particles. E. addition of a detergent at a very low-concentration can a) produce a surfactant layer at the air-water interface to avoid the protein unfolding b) and can reduce the surface tension and getting better and thinner ice. Unfortunately these conditions can lead to changes in the particle or affect the resolution but in some cases there may be no alternative and at least a low resolution map may be constructed. Images courtesy of Lou Brillault, University of Queensland.*

Membrane proteins play particularly important roles in cells and it is estimated that 20–30% of the genes in all known genomes encode membrane proteins and yet their structures are highly underrepresented in the Protein Data Bank. They have been difficult to crystallise or study by other techniques, but cryo-TEM has been successfully used for the structural studies of many membrane proteins and is now the method of choice. It is necessary to solubilise them from their biological membranes and then to stabilise in an analogous micelle, membrane or other substrate. This can involve major experimental work and also be specific to the protein of interest.

The choice of the correct detergent to solubilise them from the membrane lipidic environment can be critical. Recently a new class of solubilising agents has been designed, consisting of a mixed copolymer with a hydrophilic backbone and hydrophobic side chains, known as amphipols. These have many advantages including improved stability, enhanced contrast, and improved particle distribution. Nanodiscs, a region of the membrane bilayer held together by a belt of membrane scaffold proteins have also been used for stabilising the protein or protein complexes for SPA. This area continues to expand and several other techniques like liposomes, bicelles and styrene-maleic acid copolymers particles have also been used.



A comparison of the different methods of membrane protein stabilization. After Sgro, G.G and Costa, R.D. *Front. Mol. Biosci.* 2018, 5,74.



Structure of trimer glutamate transporter that was stabilized using a nanodisc as shown in yellow. A. Top view. B. Side View. Courtesy of Alastair Stewart, Victor Chang Institute, Sydney.

# Specimen screening by negative staining

It is important to know as much as possible about the sample prior to actually performing cryo-TEM, to ensure the stability and homogeneity of the particle.

The simplest way to perform visual screening is to use negative staining with a room temperature TEM (described briefly in the Transmission Electron Microscopy module). Basically, the sample is deposited on the supporting film of a TEM grid and embedded in a layer of a heavy metal, which gives high contrast allowing visualisation of even the fine structure of the sample. The background is stained darkly while the specimen appears pale, hence the term negative staining.

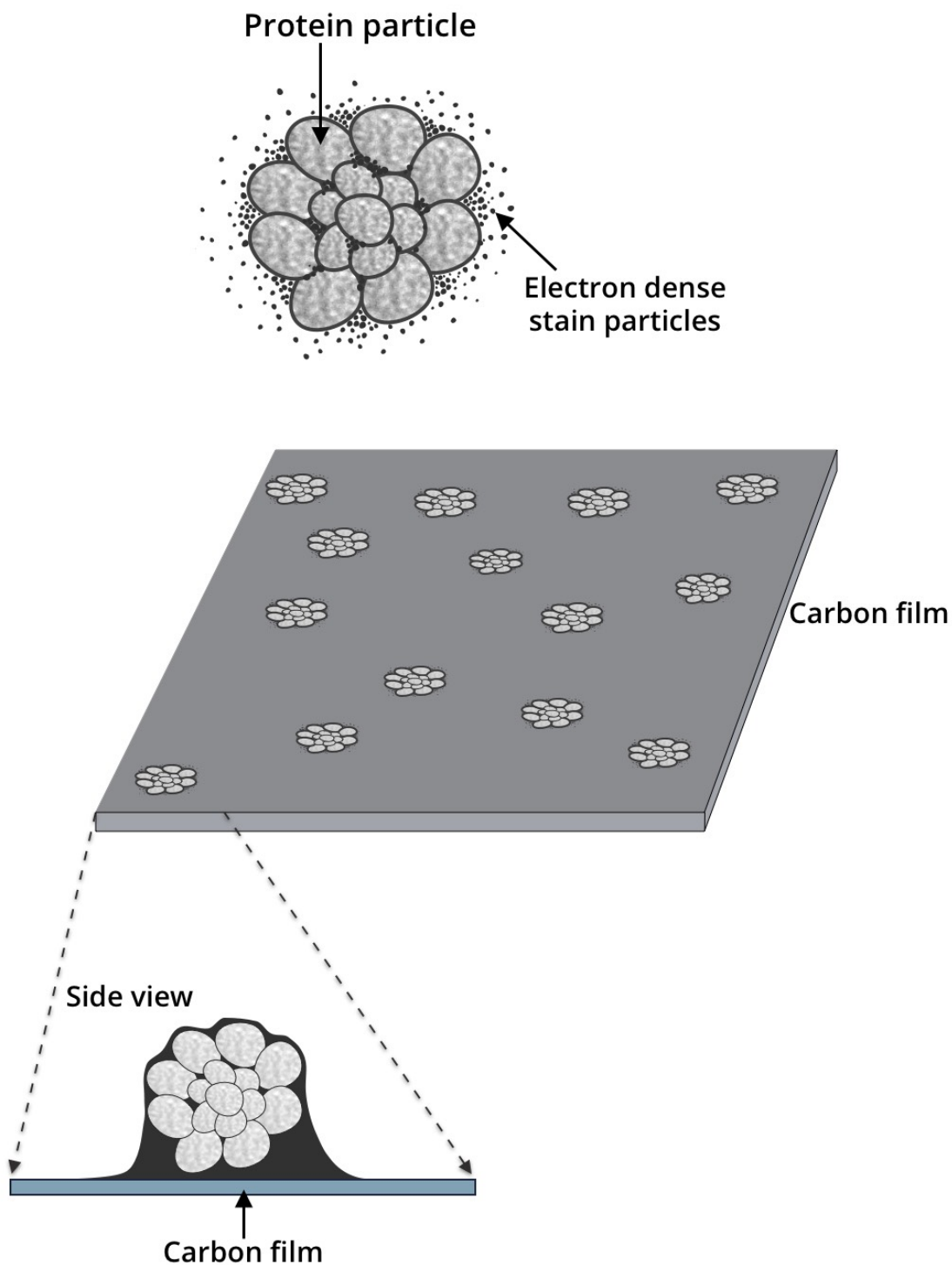
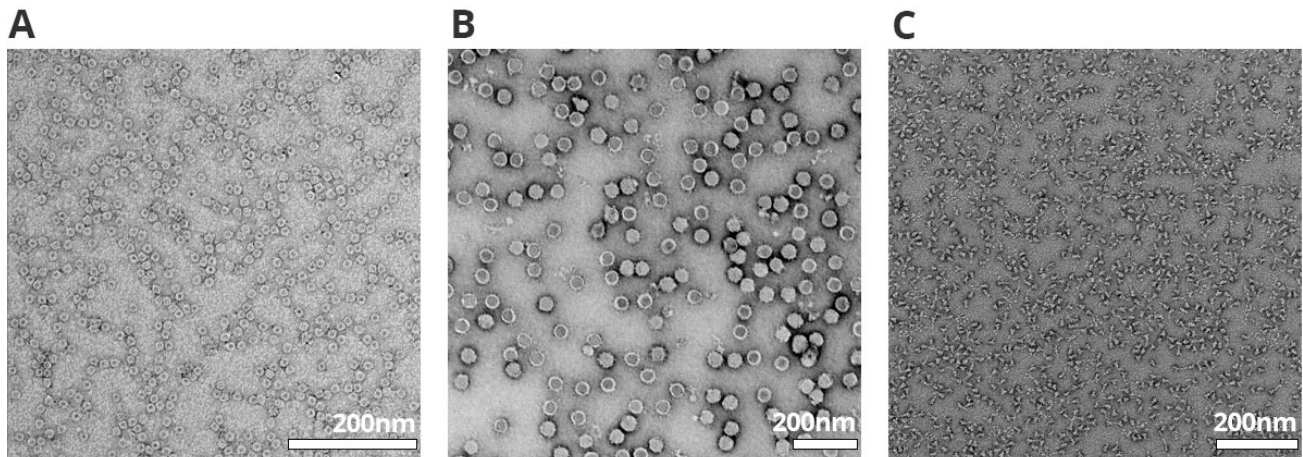


Diagram showing the principle of negative staining with the sample appearing light against a dark background of heavy metal stain.

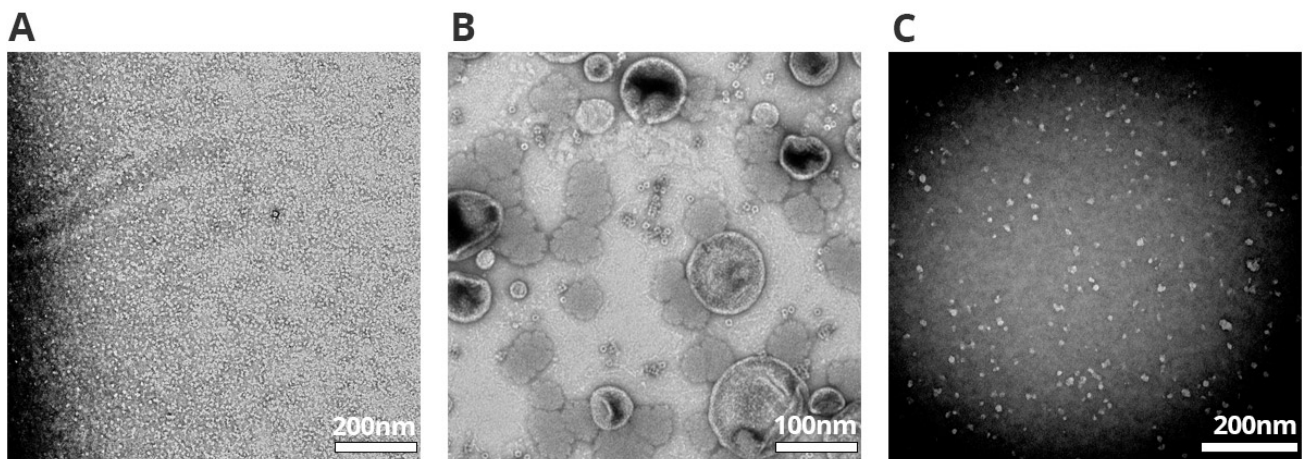


Many different stains are used for negative staining, including phosphotungstic acid and ammonium molybdate, but uranyl acetate at a concentration of 1-2% is the most common for single particle work. It is sensitive to light and needs to be filtered or spun to remove precipitates immediately before use.

While it is a quick and easy technique, limitations associated with the relatively large grain size and non-uniform dehydration artefacts limit the interpretation of structural features to a resolution of  $\sim 20 \text{ \AA}$  at best. Well stained samples will give information on particle distribution and homogeneity. Low resolution 3D reconstructions are possible using negative staining and can sometimes provide a starting reconstruction that can later be refined with cryo-EM.



Examples of good negative stained particle preparations. A. Apoferritin. B. Virus-like particles. C. SARS-CoV-2 spike protein. Images courtesy of Naphak Modhiran, University of Queensland.



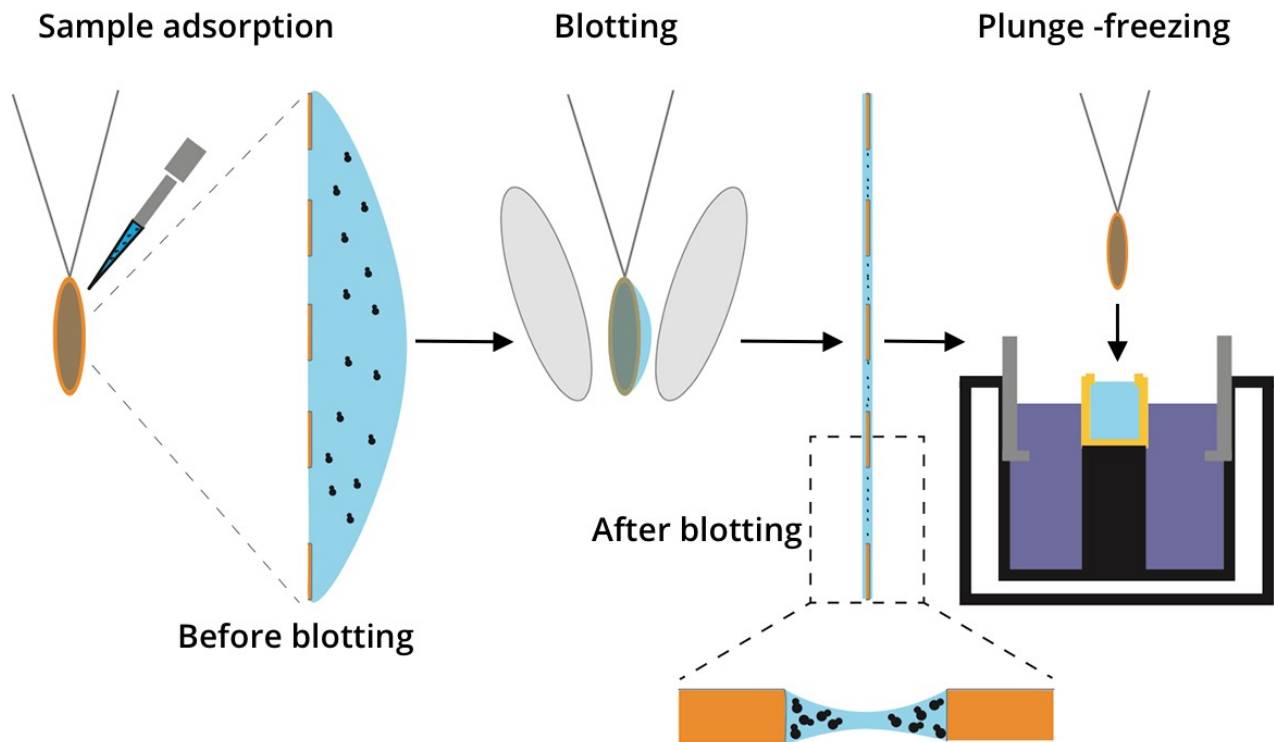
Examples of poor negative staining preparations. A. Poor stain distribution. B. Contaminants in the preparation and low particle numbers. C. Staining too heavy. Images courtesy of Naphak Modhiran, University of Queensland

# Vitrification

The purpose of vitrification is to preserve the purified sample in a thin layer of amorphous ice on a TEM grid so it will be presented to the cryo-TEM in as near as possible to its original native state.

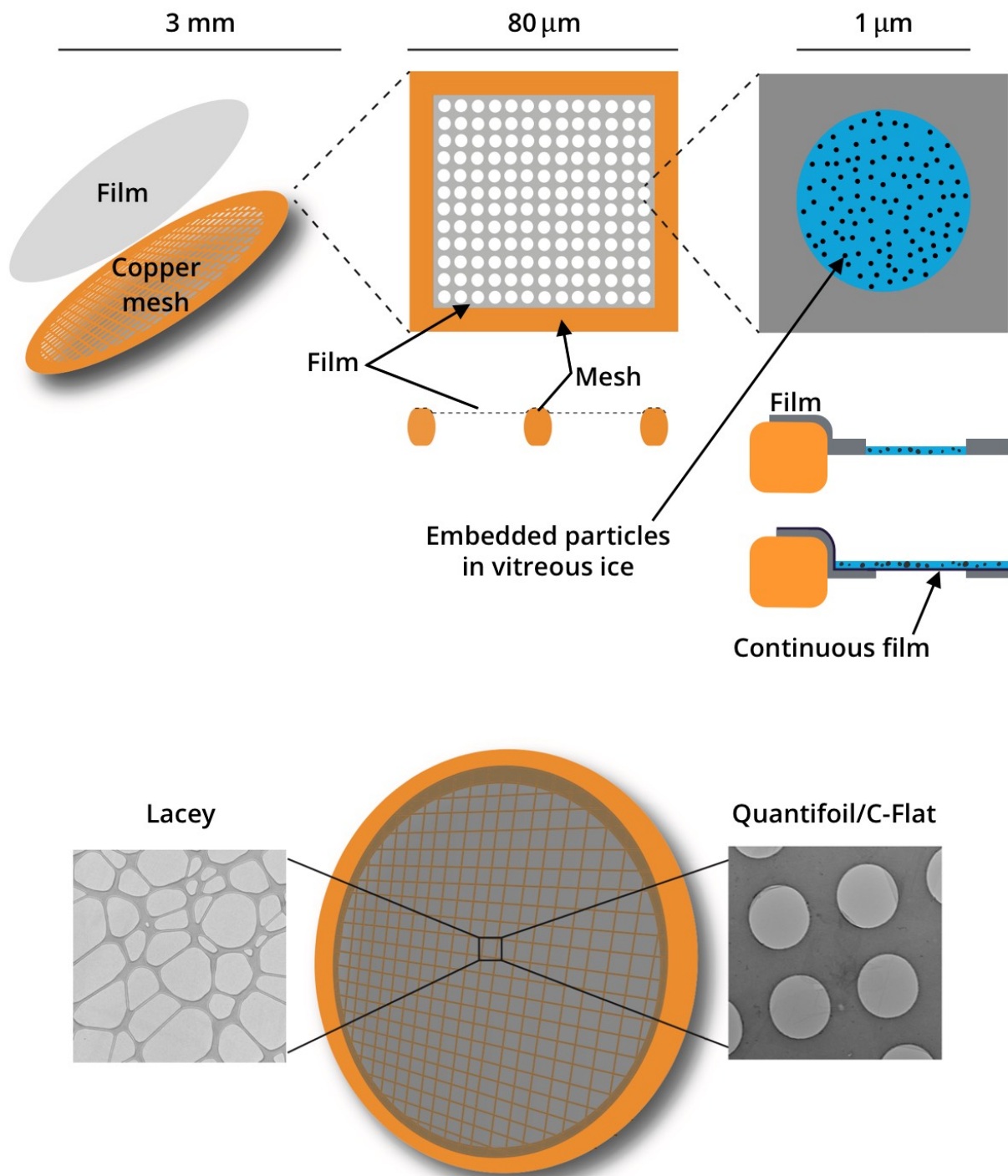
Generally, the way that samples are prepared for SPA studies involves three main steps:

1. a small liquid droplet containing the suspension of particles is applied to the carbon surface of an EM grid
2. the liquid droplet is blotted with filter paper until only a very thin film of fluid remains
3. the grid is then plunged into the cryogen.



*Workflow for loading the sample particle solution onto a grid, blotting and then plunge freezing into liquid ethane. Figure courtesy of Lou Brillault, University of Queensland.*

The grids used for this are holey carbon coated so that the ultrathin frozen solution of particles is suspended in the holes with no supporting film sitting behind it. Films with a regular repeating array of circular holes (commercially prepared as Quantifoil or C-Flat grids) are usually used because they facilitate automated data collection and the even spacing and shape allow for a more repeatable particle distribution. Alternatively, grids with irregular hole size and distribution, such as lacey carbon, that can readily be prepared in the lab, can also be used.



*The copper EM grid is coated with a thin layer of perforated amorphous carbon. Commercially available grids have an array of regularly sized and spaced holes. Lacey films with irregular holes have also been used but the random nature of the holes makes good particle freezing difficult. The sample is frozen in a layer of vitrified water in the holes. In specific cases, application of an additional continuous film (for example amorphous carbon) over the holes can be beneficial. Figure courtesy of Lou Brillault, University of Queensland.*

Several different commercial plunge freezing instruments are now available that allow control of all the freezing parameters such as temperature, humidity, blot force and blot time. In general, the most commonly adjusted parameter to alter ice thickness is the blot time, which controls how long the filter paper is held against the grid. The aim is that the particles should be evenly spread across the grid in a broad distribution of orientations. Ideally, for cryo-TEM the particles should be contained in a thin layer of vitreous ice, with a thickness as close as possible to the dimensions of the particles themselves to minimise multiple scattering events and maximise sample contrast in the TEM. Achieving the perfectly prepared cryo-EM grid, however, can be a difficult process and often requires extensive trial and error.

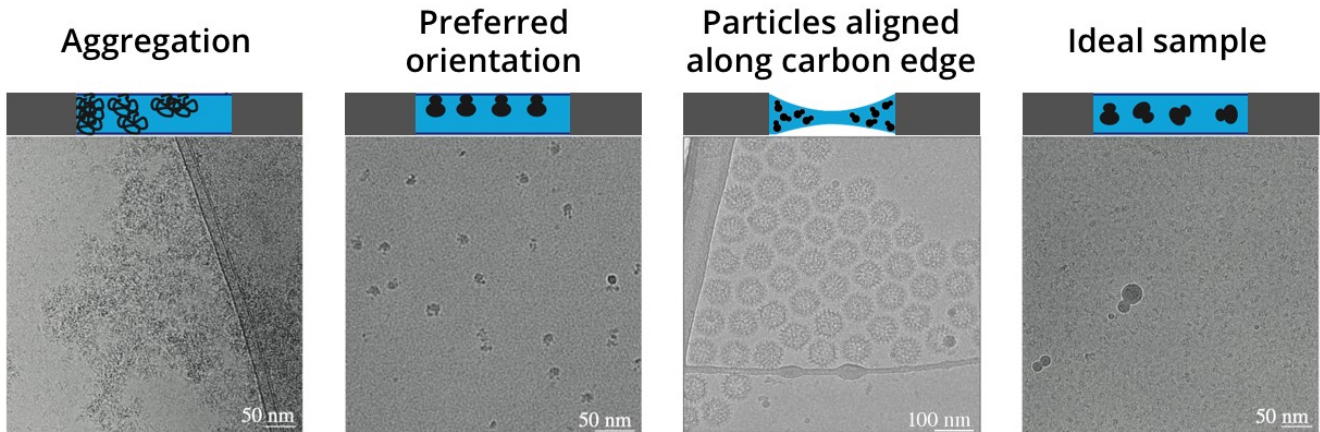
Once the specimen is frozen, the grid is then stored in liquid nitrogen in specific grid boxes until it is ready to be loaded into the electron cryo-TEM for imaging.

# Optimisation of orientation and distribution

An ideal frozen cryo-TEM sample for SPA contains particles that are evenly distributed and that present a range of orientations. However, this is not so easy to achieve and many issues can arise:

- proteins are prone to denaturing or aggregation
- they can preferentially adhere to the carbon film and so not distribute evenly across the holes
- not present a wide range of views as they preferentially align in specific directions.

It can take some trial and error to achieve the ideal sample and screening within the cryo-TEM is always necessary prior to acquisition of the final data.

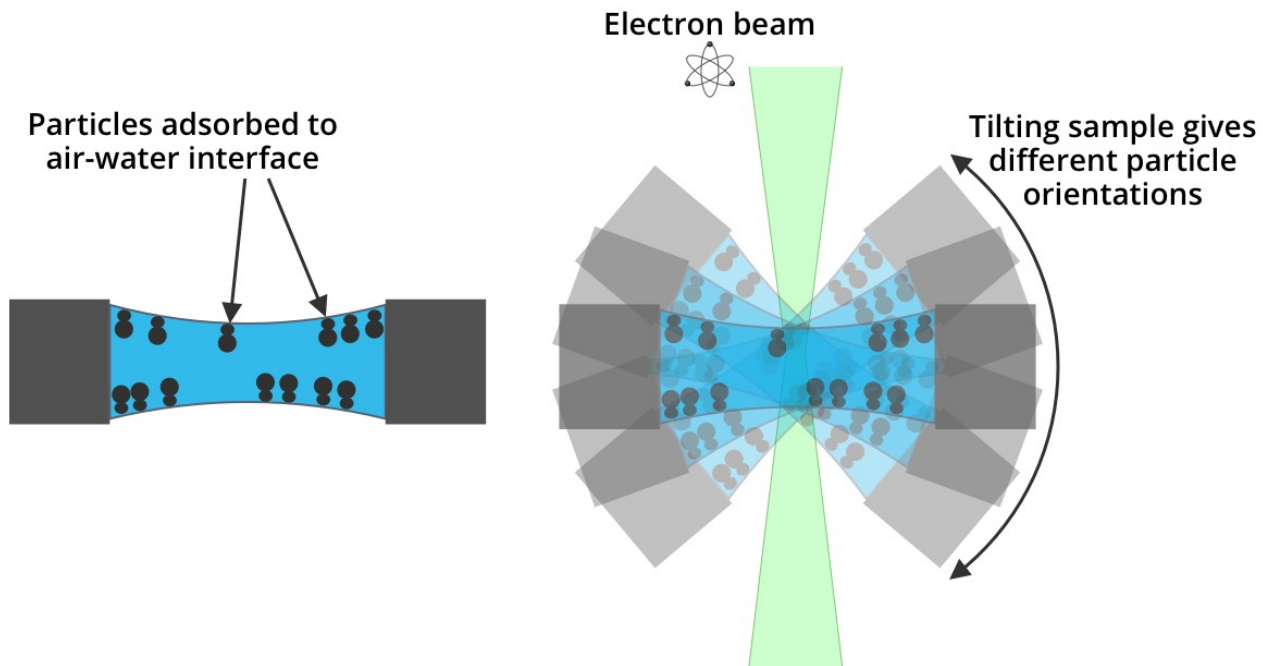


Examples of poor particle distribution, showing aggregation and preferred orientation at the air–water interface and along the edge of the carbon film. Figure courtesy of Lou Brillault, University of Queensland.

Particles tend to preferentially gather at the air–water interface and this contributes to a lot of the issues encountered during vitrification. Most crucial is that the particles orient in only the one direction. By adding another thin film, usually carbon, graphene or graphene oxide, over the holes to produce a continuous film, the particles have something to adhere to. This can overcome some issues like low particle concentrations and distribution across the holes, and lead to more random orientations of the particles. However, the additional carbon film will reduce the signal to noise ratio.

Glow discharge, exposing the grids to a low-energy gas plasma, is used to make the surfaces more hydrophilic to allow more even spreading of solutions across the grid. Performing this in an amylamine-enriched atmosphere gives a net positive charge to the carbon film, which can repel the particles and force them into the holes. Hydrophobic grids can have a similar effect.

If there is great difficulty in obtaining an even distribution of orientations another possibility is tilting the grid. The unfortunate side effect of this is that the ice layer becomes thicker at the higher tilt angles reducing image quality. However, algorithms have now been written that can help to alleviate this issue.



*A. Particles can align to the air-water interface so they all show the same orientation. B. Tilting the grid to different angles will give different orientations of the particles.*

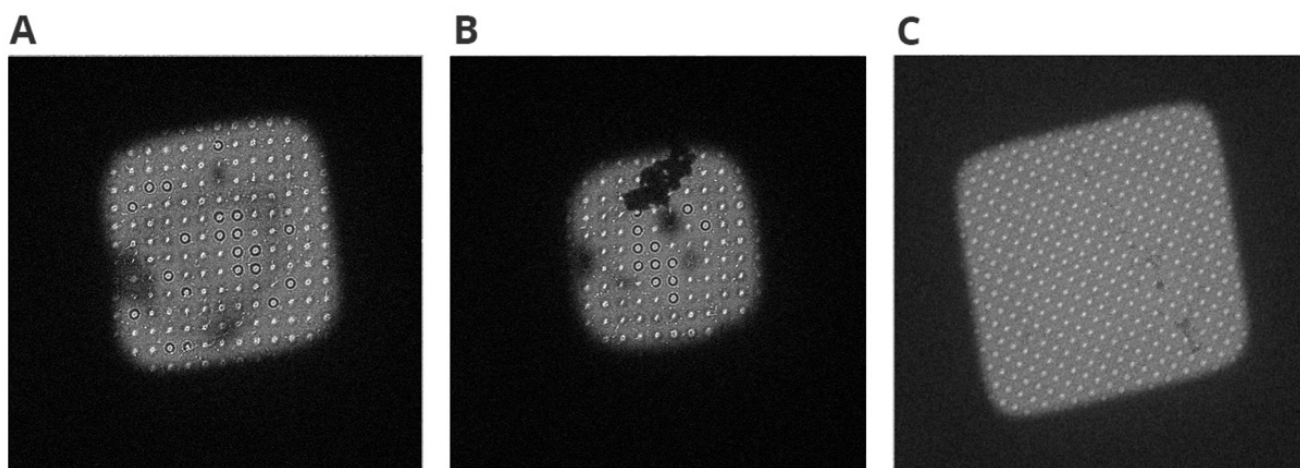
New freezing instruments have been developed that are designed to overcome particle adhesion to the air-water interface. They deposit ultra-small droplets onto the grids in a time scale that prevents this redistribution of particles. This also means that only very small volumes, from nanolitres to femtolitres, of the suspensions are needed. Various technologies have been used to do this, including a piezo dispensing device, electrostatic systems, pin printing and ultrasonic sprays, as well as cryojet freezing. Commercial versions of some of these are now available.

# Specimen screening by cryo

While screening using negative staining can be very informative about the sample quality there are many issues associated with the vitrification process that can cause major problems for SPA. It is therefore necessary to do another set of screenings of the fully frozen particle sample in the cryo-TEM before proceeding. This screening is incredibly important to the whole process as it is not worth progressing to the actual collection of the data on anything but a very good sample. This ideal sample contains a good distribution of homogeneous particles that is supported by a thin layer of vitreous ice.

During the screening phase, images are recorded at a range of magnifications to check the value of a sample for cryo-TEM data collection and most specifically ice and particle quality.

A low magnification view of the entire cryo-EM grid, called an atlas, is constructed by stitching together a series of images to produce a grid overview. Here, ice thickness can be discerned by the electron transparency. The dark areas where it is overly thick are discounted. At medium magnifications it is possible to check for ice crystals, poorly vitrified ice, or other contamination as well as for regions of thicker ice within the holes. If the ice is too thick the signal-to-noise ratio will be poor.

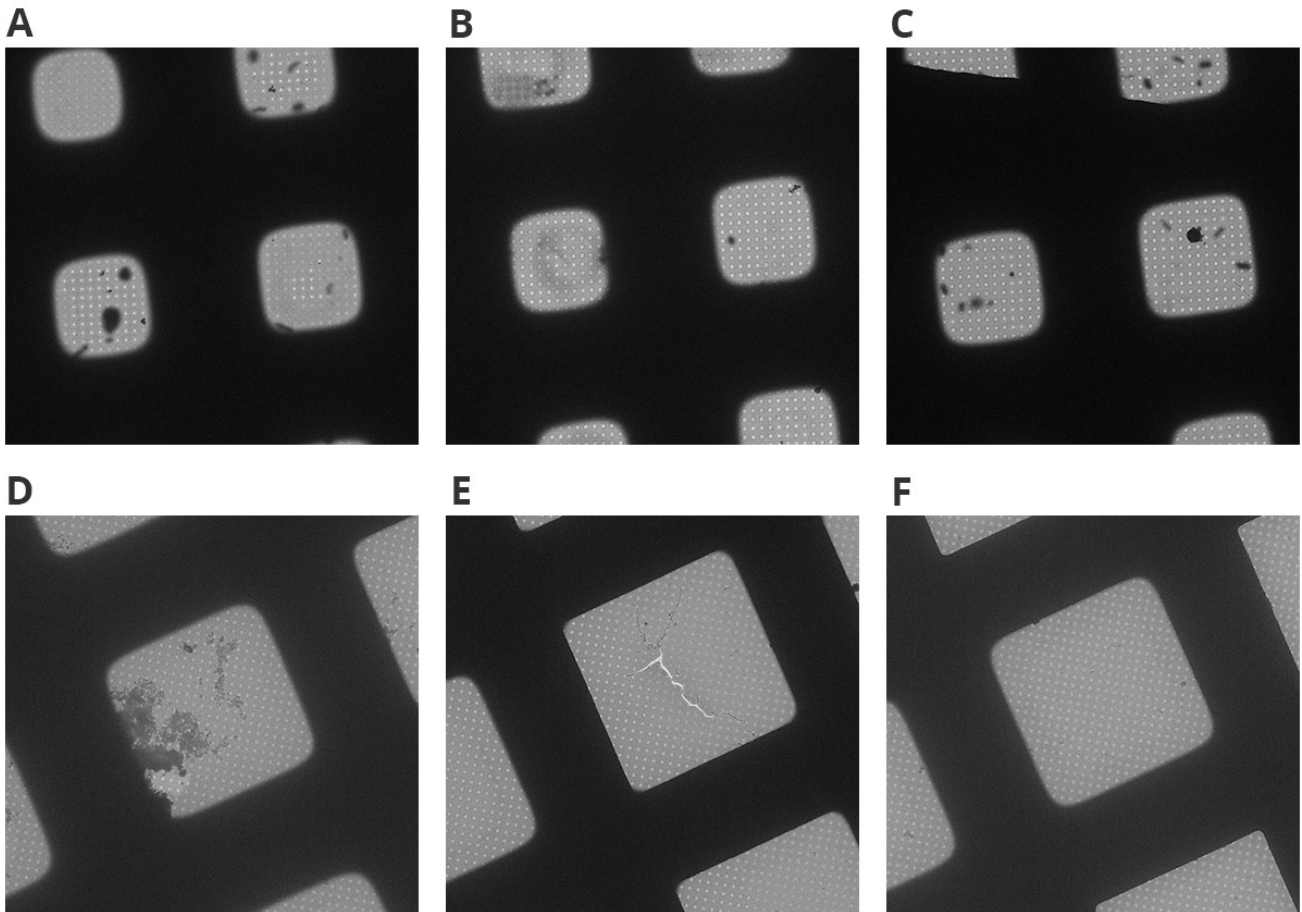


*How to tell good grid squares worthy of closer inspection A. There are some good holes that exhibit an even pale colour as well as poor ones with darker regions of thicker ice, and holes with a dark circle around them that are dry holes that have been too heavily blotted so are now empty. B. Some similar issues to those in A and this square has areas of thick ice around the edges that obscure a large region of it. C. Almost all of the holes in this square would be good as they show an even pale colour. Small amounts of ice contamination obscure a couple of the holes.*

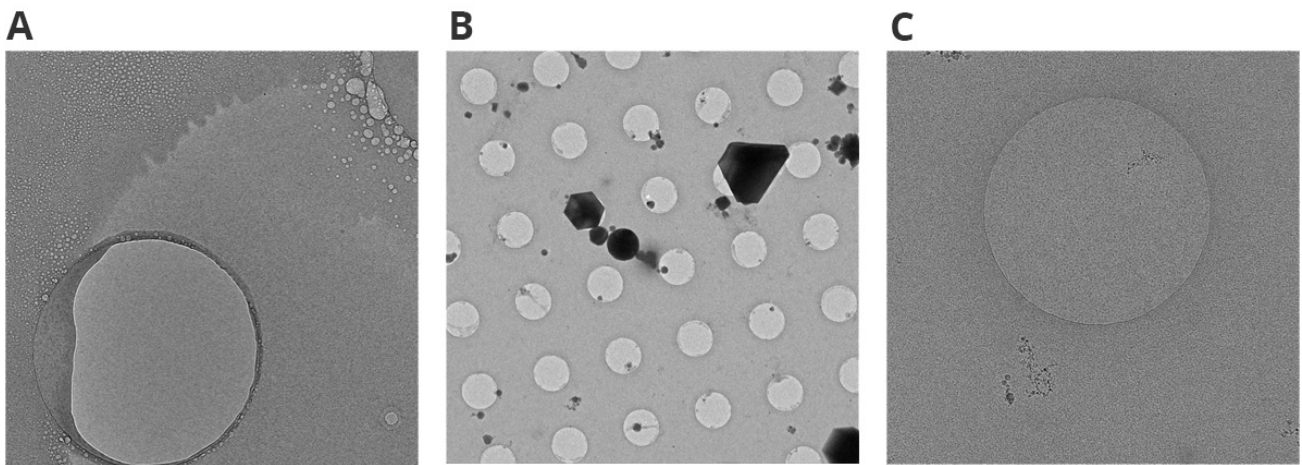
Higher magnification views allow the checking of the particles themselves to ascertain traits of the sample, including:

- concentration (ideally plenty of particles are present but not overlapping or touching each other)
- aggregation
- denaturation
- non-uniform particle distribution (e.g., particles preferentially incorporating in the hole's centre or at the carbon edge)
- preferential orientation.

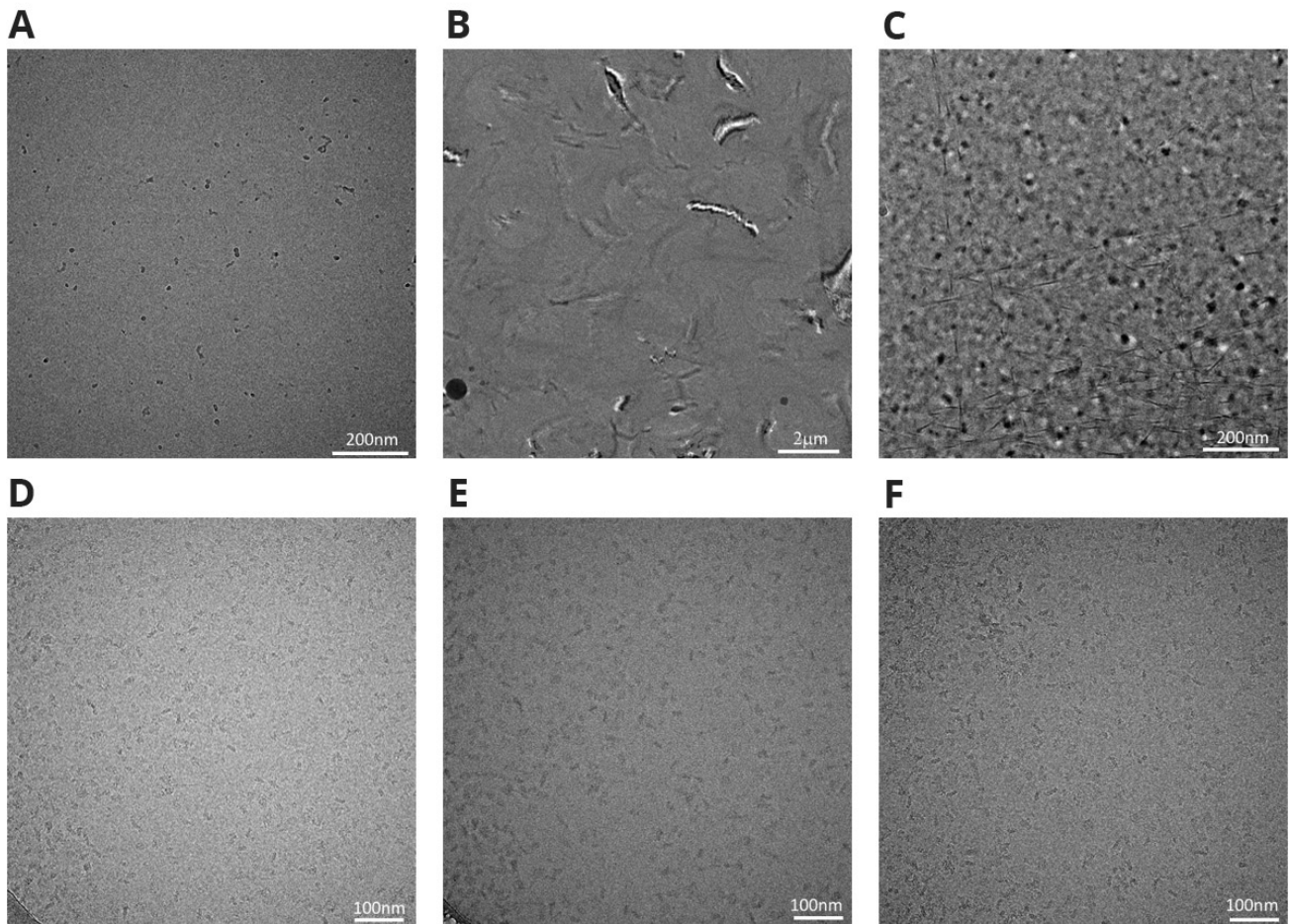
Some issues like particle damage are often more easily recognised during post-imaging analysis such as 2D classification. In these raw images seeing the particles clearly enough to evaluate them can be tricky due to the poor signal to noise and the low contrast so it may be necessary to increase the defocus especially for smaller particles.



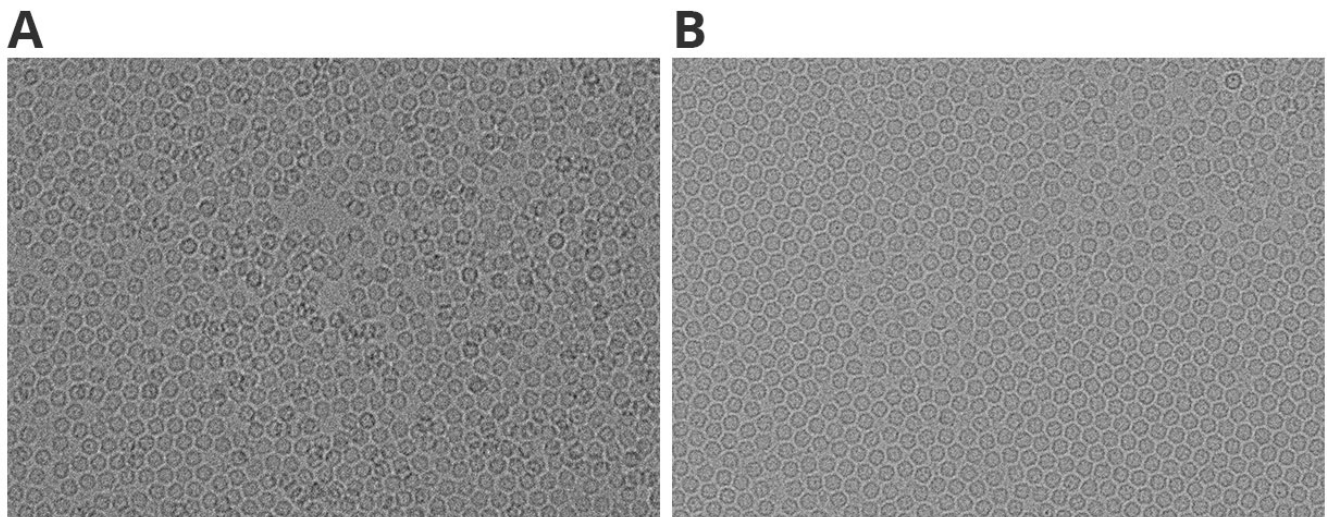
Problems with vitrified samples. A, B, C, D show regions of thick ice and contamination. E. a crack in the grid film. F. This is an ideal grid with ice of a good thickness. Images courtesy of Juanfang Ruan, University of New South Wales and Lou Brillault, University of Queensland.



Problems with vitrified samples. A. Radiation damage, B. Large hexagonal Ice. C. This is an ideal grid with ice of a good thickness. Images courtesy of Juanfang Ruan, University of New South Wales and Lou Brillault, University of Queensland.



*Problems with vitrified samples. A. Ethane contamination, B. Ice crystals. C. Ice crystals. D. Good particles. E. same area as in D but showing radiation damage after beam exposure. F. aggregation of particles, especially at the edge of the hole adjacent to the carbon, which is on the left of the image. Images courtesy of Juanfang Ruan, University of New South Wales and Lou Brillault, University of Queensland.*



*Problems with vitrified samples. A. The concentration of the particles is too high as many are overlapping each other. B. Good hole with good concentration of particles. Images courtesy of Naphak Modhiran, University of Queensland.*

The cryo-TEM SPA workflow is an iterative process that requires going back and forth between sample purification, grid preparation and grid screening in order to obtain the ideal sample on which to perform the analysis.



# Data acquisition

---

After your sample and grids have been optimised you are ready for cryo-TEM data collection. Of course, a standard set of microscope alignments should be performed to ensure that the imaging parameters of the instrument are set up to allow capturing of high resolution images. The microscope must be aligned with parallel illumination to avoid deterioration of the images due to the small local variations in defocus and magnification.

As stated earlier, vitrified samples are quite susceptible to radiation damage from the electron beam. To reduce this problem the microscope must be operated in 'low dose' mode, where the sample is exposed to a minimal electron dose sufficient to allow enough information to be acquired in the resultant image. Of course, images of this type will be incredibly noisy and useless as single images. As mentioned previously, data acquisition in the microscope involves taking large numbers of images containing many particles and then by averaging all these images the high-resolution information is achieved.

During grid screening, the holes where the sample quality is sufficient for data collection, are marked in the software so the microscope can return to them for image acquisition.

The standard workflow for collecting images is a search (target)-focus-record strategy.

- The search takes place at low magnification and moves the beam to the region of the sample to be imaged.
- To adjust the focus, the microscope moves to an area adjacent to area to be imaged so the sample itself is not exposed to the beam during the procedure. This is usually done on the carbon film.
- Record moves to the exact location for image acquisition.

Stage movement should be restricted as this slows the process, waiting for the stabilisation after each move.

Speed of data collection is important and beam deflection to successive acquisition positions is now used. Aberration-free beam tilting strategies compensate for this shift to ensure optimal beam alignment for imaging. The data is acquired as a movie of many frames which are later aligned and averaged. All the data collection is performed by systematically moving across the grid to all the hole locations marked at the screening phase. The important consideration in these approaches is speed of acquisition and the new faster readout detectors and aberration-free beam-tilt acquisition helps make this possible. The microscope can be programmed to do this process over hours to days.

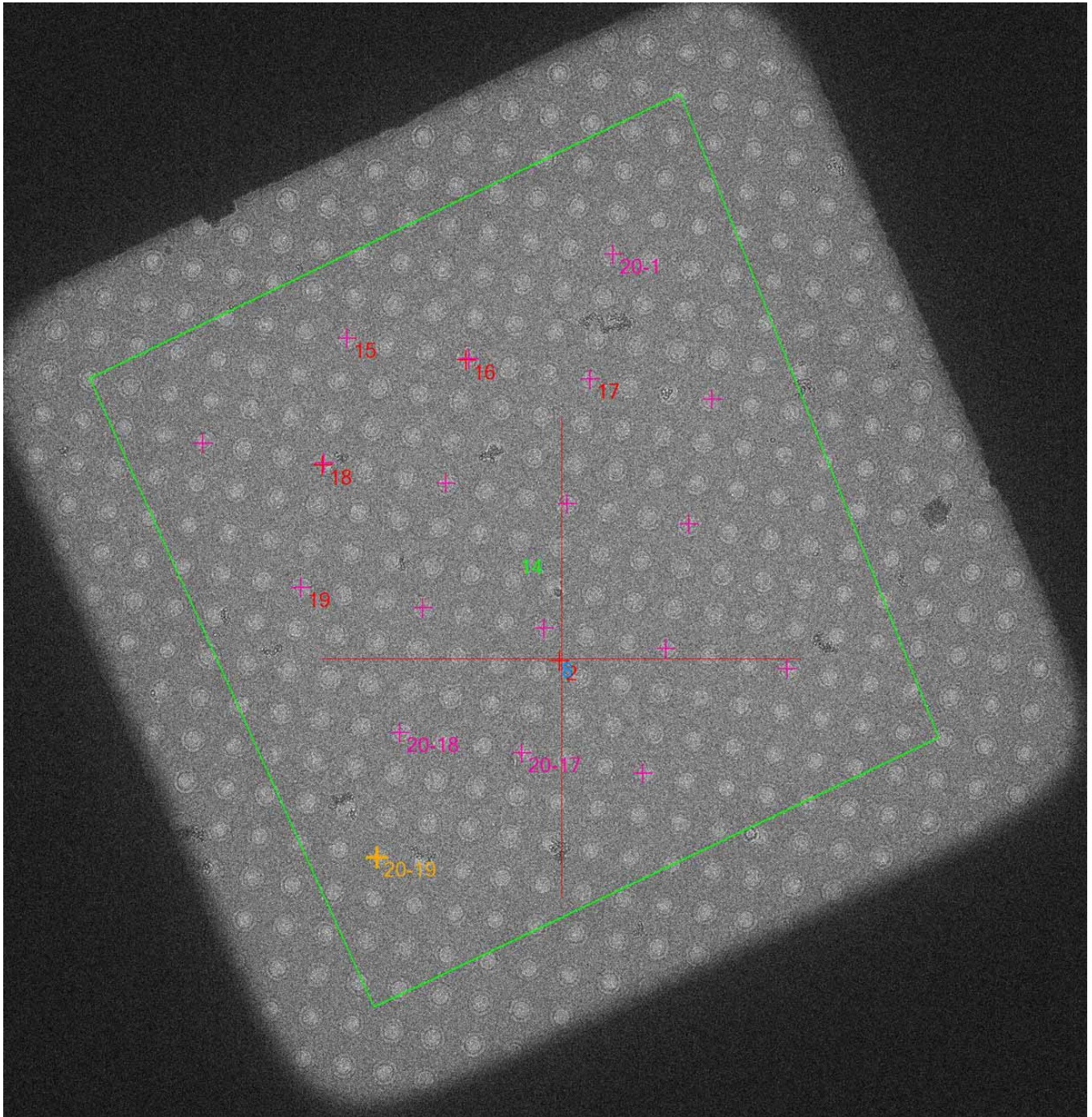
Collecting a single movie from a hole is commonly performed using one focus point for an array of holes laying adjacent to this. Collection of several datasets from the same hole improves throughput and thousands of movies can be collected in a day.

Several parameters need to be addressed in order to work out the best recording settings:

**Defocus:** This setting is a compromise between high defocus giving high contrast but decreased resolution and low defocus with lower contrast and more high-resolution information. Both high and low contrast data are valuable with the high contrast data often used for initial alignments during processing. Usually, a smaller defocus is used for large particles and a higher defocus is used for smaller particles. Typically defocus settings are between -0.5 to -1.0  $\mu\text{m}$  with a maximum of -2.0  $\mu\text{m}$ . The microscope will collect images at a range of defocus settings from the set point as this information is necessary to allow CTF correction, so it is this range that is being set with defocus. Recent work is showing that for the highest resolution, data should be collected as close to focus as possible.

**Magnification:** This relates particularly to resolution as it determines the pixel size. According to the Nyquist Theorem the highest theoretical resolution will be twice the pixel size, though this is limited by other microscope, detector and processing issues. Higher magnifications will give higher resolutions but more beam damage and a smaller number of particles per image.

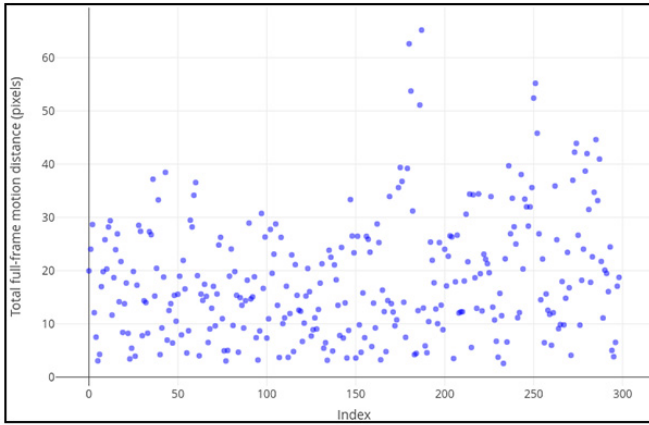
**Dose:** The dose used is a balance between causing radiation damage and producing sufficient signal to obtain high resolution information. Typically, exposures of 30-50  $\text{e}/\text{\AA}^2$  are used but doses as low as 25  $\text{e}/\text{\AA}^2$  have been used to acquire the high-resolution data. The later frames in the movie suffer from accumulated higher dose and so are 'dose weighted' or exposure filtered to have less influence during initial processing.



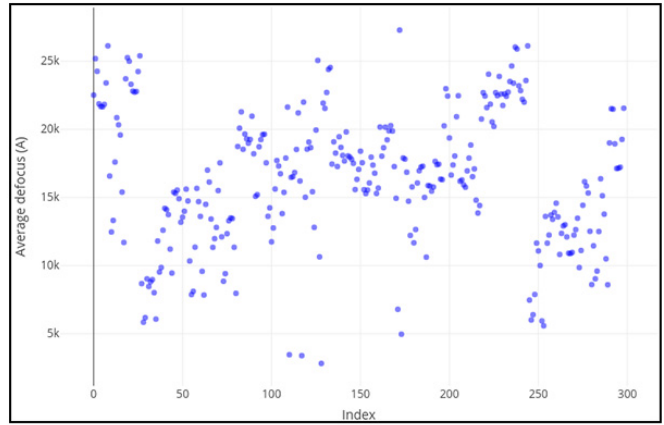
Low magnification image of a grid square showing the holes marked for data acquisition. The pink cross marks a location where imaging will take place in the 9 surrounding holes. The focus point will be on the carbon adjacent to the central hole of the nine. Image courtesy of Lou Brillault, University of Queensland.

Modern cryo-TEMs monitor the data collection giving direct feedback about its quality, by measuring parameters like motion, average defocus, relative ice thickness and even estimated resolution CTF fit. A lot of image processing is actually performed on-the-fly during acquisition of the data. Initial motion correction, dose weighting and averaging can all be done at this time.

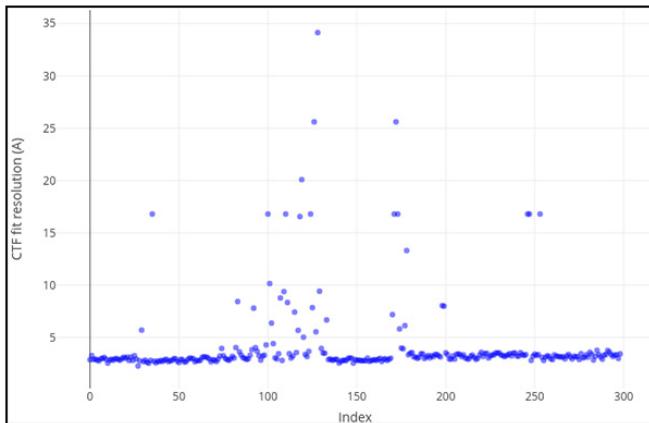
## Total full frame motion



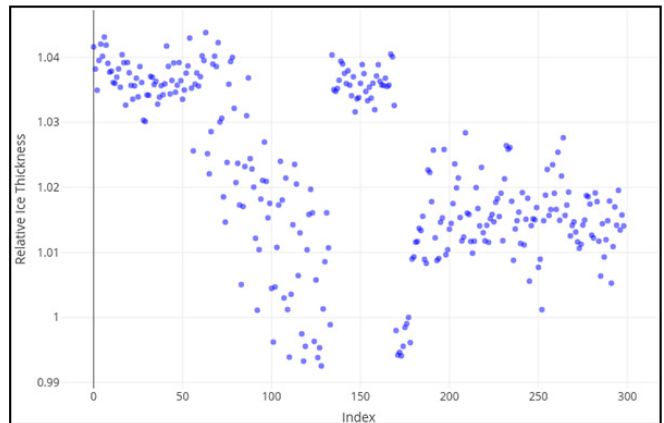
## Average defocus



## Estimated resolution of CTF fit



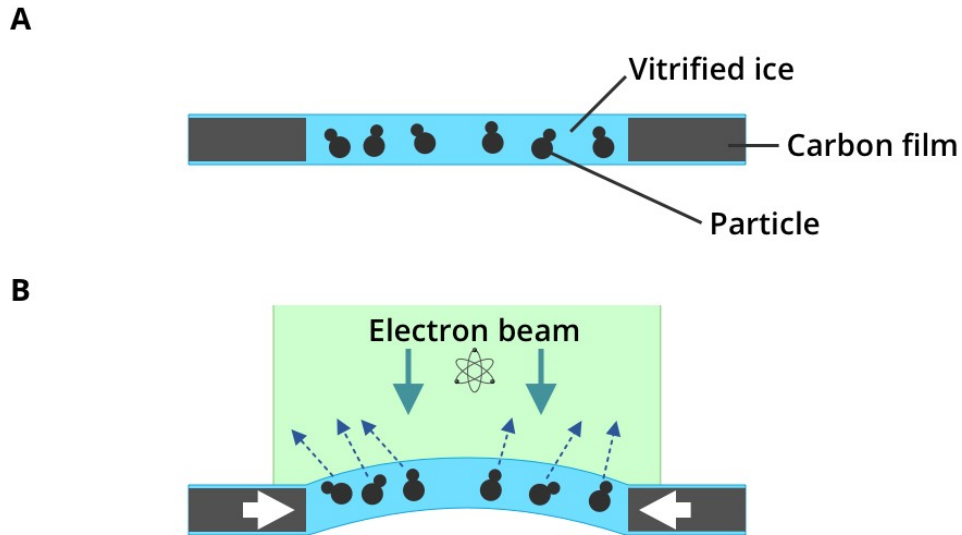
## Relative ice thickness



Information on the quality of data being acquired can be accessed during or directly after imaging. The index on the x axis is the movie number. In this case the total frame motion, the average defocus, the estimated resolution of the CTF fit and the relative ice thickness have been calculated. If these figures are not within prescribed limits, individual movies or the entire the data set could be abandoned. Figures courtesy of Michael Landsberg, University of Queensland.

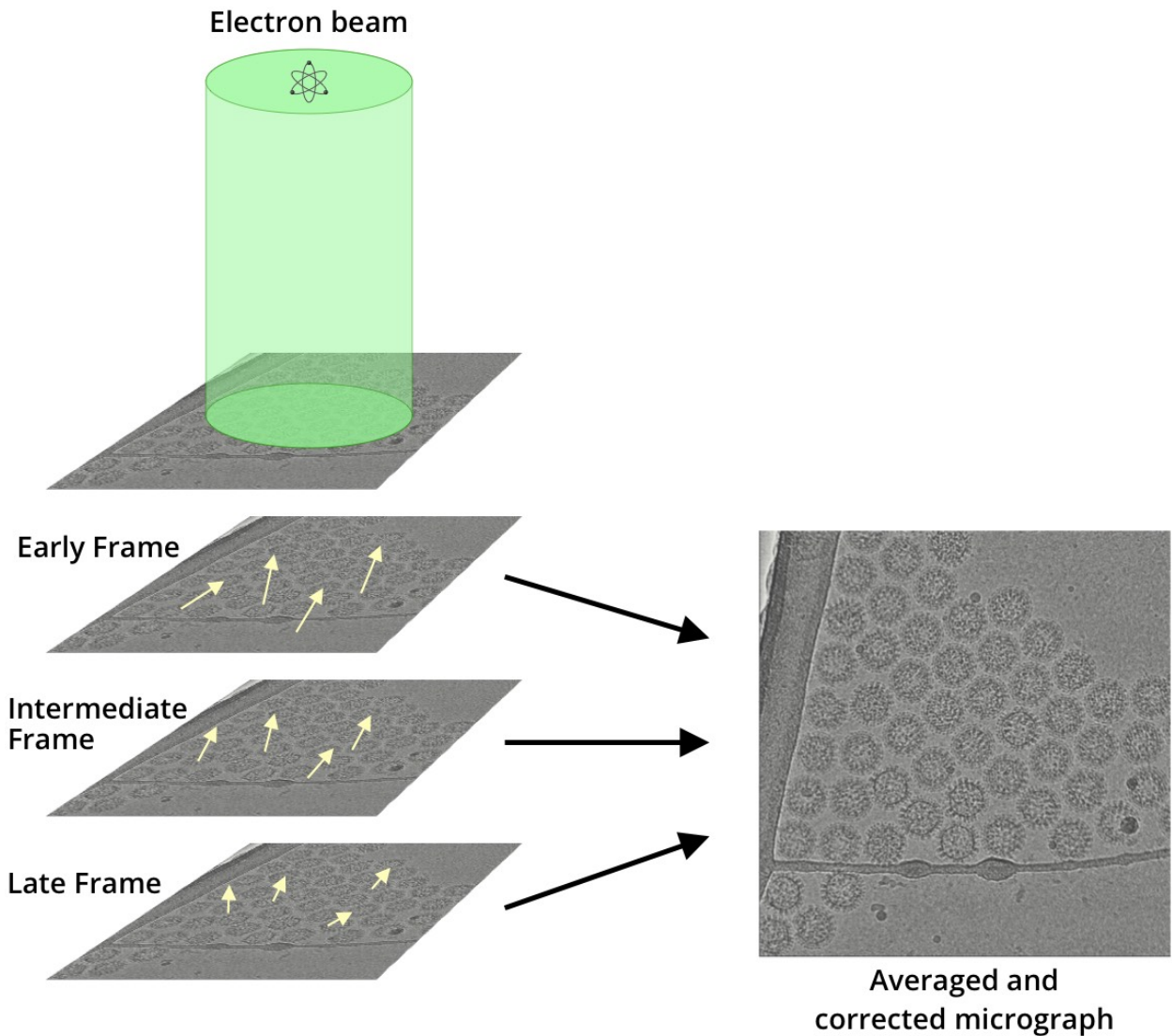
# Motion correction

Despite the use of the low electron doses for imaging, the electron beam induces specimen movement resulting in blurring of high-resolution details. The development of the MAPS direct electron detector with fast readout of data can address this problem by acquiring multiple subframes with the dose fractionated across each. However, the subframes of the acquired movie do not align because there will always be some beam induced motion. Algorithms have been developed that align them to correct for this beam-induced motion in a process commonly known as motion or drift correction.



*A. Particles vitrified in ice in a hole in the carbon film. B. During electron beam radiation the carbon film reduces the size of the hole and pressure is increased in the ice. These effects cause the ice to move in random directions causing both shifts and rotations.*

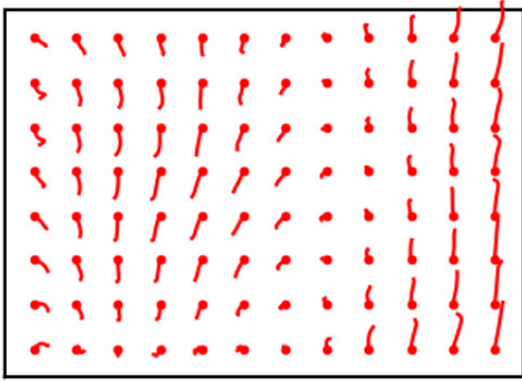
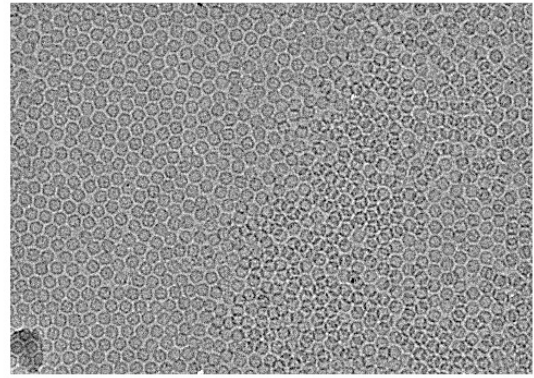
The initial radiation damage causes strong movement which is not uniform across the grid. This drops off with further irradiation and the later subframes show little to no movement.



*Motion is different in different regions of each micrograph in the movie stack and the movement becomes less in the later micrographs as the sample settles. Motion correction compensates for the movement, aligning the micrographs perfectly and then averaging them to give a single image. Figure courtesy of Lou Brillault, University of Queensland.*

The motion correction can be done in two ways:

1. Global motion where the motion of the whole image is averaged using a cross-correlation between individual subframes. The alignment is then based on this. However, it is not a rigid body motion and different particles move in quite independent ways. To compensate for this, the image is divided into a set of small squares or patches and the motion is calculated for each of these.
2. It is also possible to correct for movement at the individual particle level but this is usually done later during the refinement stage of 3D reconstruction. A combination of the global and patch methods is used for initial image alignment. Using motion correction software all the subframes of a movie are combined and averaged to produce a single image. In new software it is possible to perform motion correction on-the-fly during the acquisition.

**A****B**

A. Diagram showing trajectories of particles in different patches within the subframes from the beginning to the end of the movie. Motion is not the same in all regions of the sample. B Motion corrected image showing good quality particles. Figures courtesy of Michael Landsberg, University of Queensland.

# Dose weighting

---

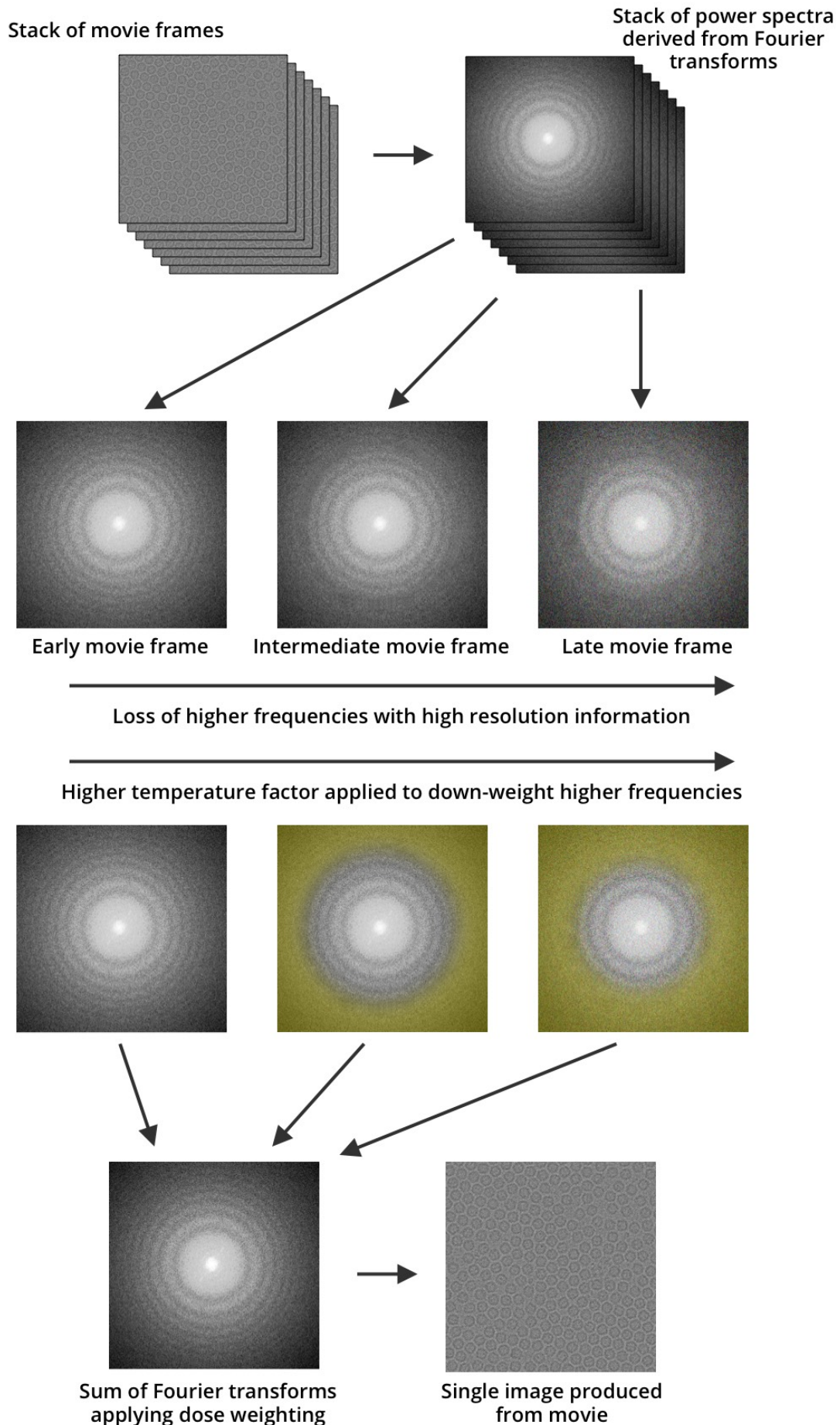
The electron beam radiation damages the frozen biological sample during the course of exposure. While the use of low dose operating conditions of the microscope reduces this, damage to the sample is inevitable as the electron dose increases.

The initial subframes collected in the movie will have only had a low electron dose and show little damage, keeping all the high-resolution detail but with very little contrast. These early frames with the highest resolution features also exhibit the greatest amount of motion.

By comparison, the later subframes have been exposed to a much higher dose, causing greater beam damage but with less movement. These later frames have higher contrast but more noise and less detail. This shows up in the power spectrum as less high frequency information (the outer rings) and more low frequency information in the form of higher contrast (the inner rings). The use of dose weighting or exposure filtering means that these higher resolution Fourier components in the later frames are down-weighted in the averaging of the frames.

The goal of dose weighting is to prevent further noise from accumulating at high resolution. The benefit of doing this is to still enhance the low-resolution SNR, or image contrast, without reducing the high-resolution SNR. Dose weighting is applied at the same time as motion correction.

However, the use of all information, ie., without dose weighting can still be very useful, particularly to the constructions of the initial low-resolution models where the higher resolution information can make it difficult to align classes easily and accurately. So, often two datasets are made, a dose weighted and a non-dose weighted set. These are directly linked so the high-resolution information can be added back once initial alignment is complete. This often happens in the background of the software and is not directly seen.



*The later frames in the movies suffer from increasing radiation damage which results in loss of high frequencies and an increase in noise. Dose weighting down-weights the higher resolution Fourier components in the later frames by applying a progressively increasing temperature factor (represented in yellow in the diagram) while retaining the low frequency information. When the Fourier transforms of all frames are summed using dose weighting the result enhances the low resolution SNR without reducing the high resolution SNR in the Dnal image. After CryoEM 101*



# Averaging

---

Even under perfect low-dose cryo-TEM conditions, individual electron microscope images do not contain enough information to provide an atomic-resolution description of a biological specimen. These images are inherently noisy because you need to use a low dose of radiation to minimise damage. This means that in a single image there isn't enough information to fully describe the specimen. As a result, cryo-TEM of biological molecules makes use of image averaging. This has the effect of removing the randomly located noise and enhancing the consistent structural information.

The vitrified sample contains multiple copies of identical structures and therefore each image from a vitrified sample of macromolecules shows identical structures presented in different views. If images of the same structure in the same view can be grouped and averaged then the high-resolution information in the images is added together, while noise is gradually averaged out. This high-resolution signal becomes clearer and clearer as more images are averaged. Averaging is used at different places along the SPA workflow, adding together subframes in the captured movies and summing together all images of particles in a 2D class. It is also used in the refining processes of the 3D reconstructions.

# Particle picking

---

Each corrected image contains many different particles in many different orientations. To be able to use each of these orientations in the reconstructions it is necessary to identify them and then extract them as individual particle images. To make a high-resolution 3D reconstruction it may be necessary to average hundreds of thousands of particles. During the workflow a large percentage of particles will be discarded due to their poor quality and often only 5 to 10% of the initial particles will be used in the final map. So, it may be necessary to select millions of particles in the original set to allow for this.

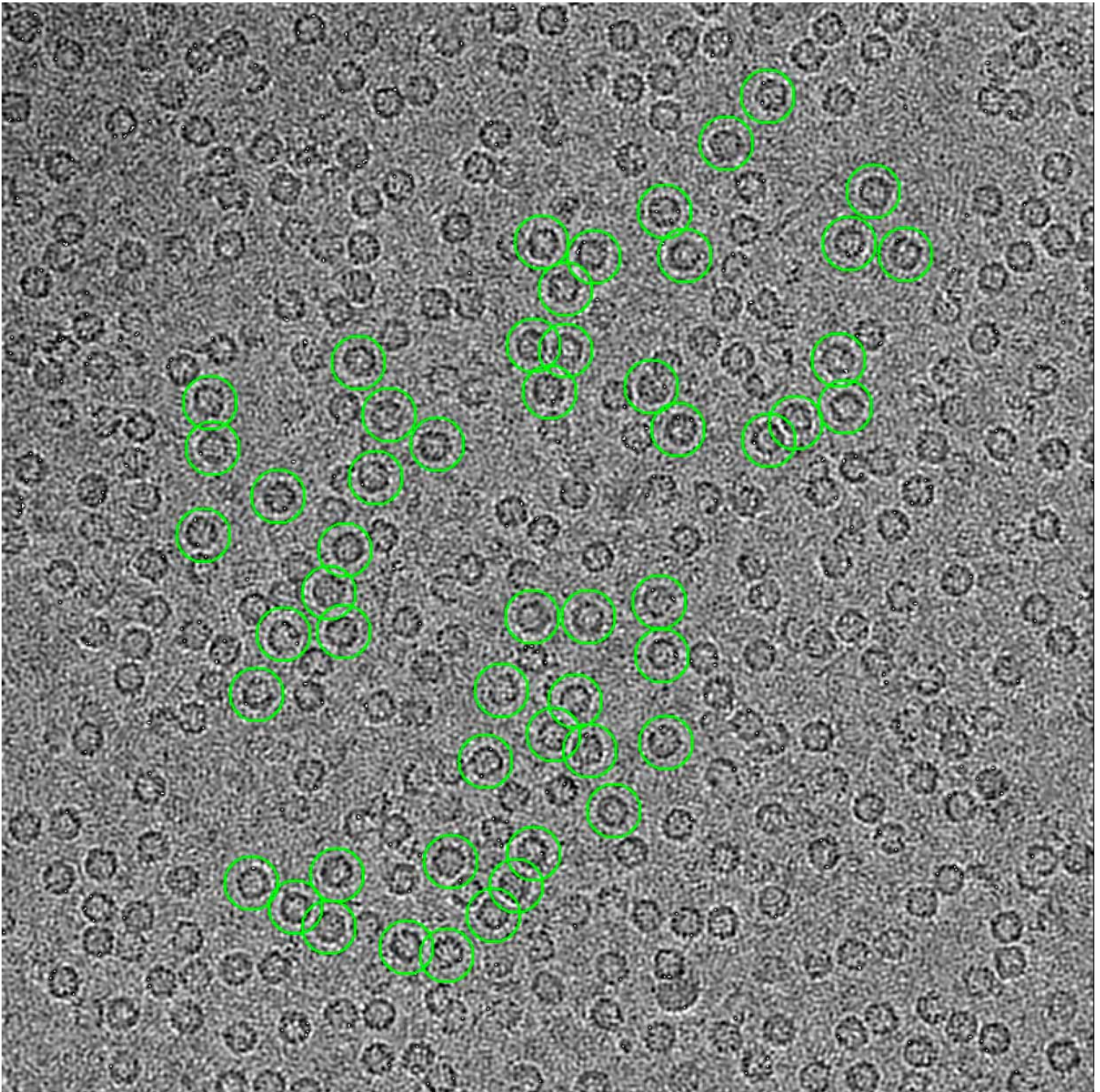
Because of the high noise and poor contrast, particles are often difficult to see in the images. To improve this and to make them more visible two strategies have been used.

1. A strong low-pass or median filter is applied to raw data. These filters suppress the fine-grained noise and enhance the contrast. These filters mask out the high frequency information in the Fourier transforms as was shown in the Fourier transform section.
2. Denoising of images provides great clarity and higher contrast. A convolutional neural network (CNN) can be trained to denoise the data and this can work well on small particles (<50kDa) that can be particularly difficult to distinguish.

Once the particles have been selected the images are again returned to their original quality to remove the effects of these strategies.

There are several methods for particle picking.

1. Manual picking - This is very labour intensive and so is really not used now for selecting the full dataset. However, a small number, perhaps hundreds to thousands of particles can be picked manually to help to train methods like Template Picking.
2. Template picking - The manually picked particles are used as templates that the software can then use to identify particles. A correlation score is set for matching to this template to maximise the number of particles being picked. Unfortunately, this can introduce a bias in the particles picked.
3. Blob picking - This works best on particles that have a roughly spherical shape. The software picks out all blobs of a given size range. While this is unbiased it can pick lots of non-particles such as similarly sized ice contaminants. So, the resultant data needs a lot of cleaning up later.
4. Well trained CNN-based selector systems currently have the highest accuracy for most datasets, especially as they intuitively improve their performance.



*Image of particles showing those that have been manually picked. This template will then be used by the software to pick out all similar structures from all images. Image courtesy of Nick Ariotti University of New South Wales.*

Once they have been identified, the particles need to be extracted so they can be used in further analysis. This is done as separate squares, each containing a single particle. The size of the particle 'box' is an important parameter for several reasons.

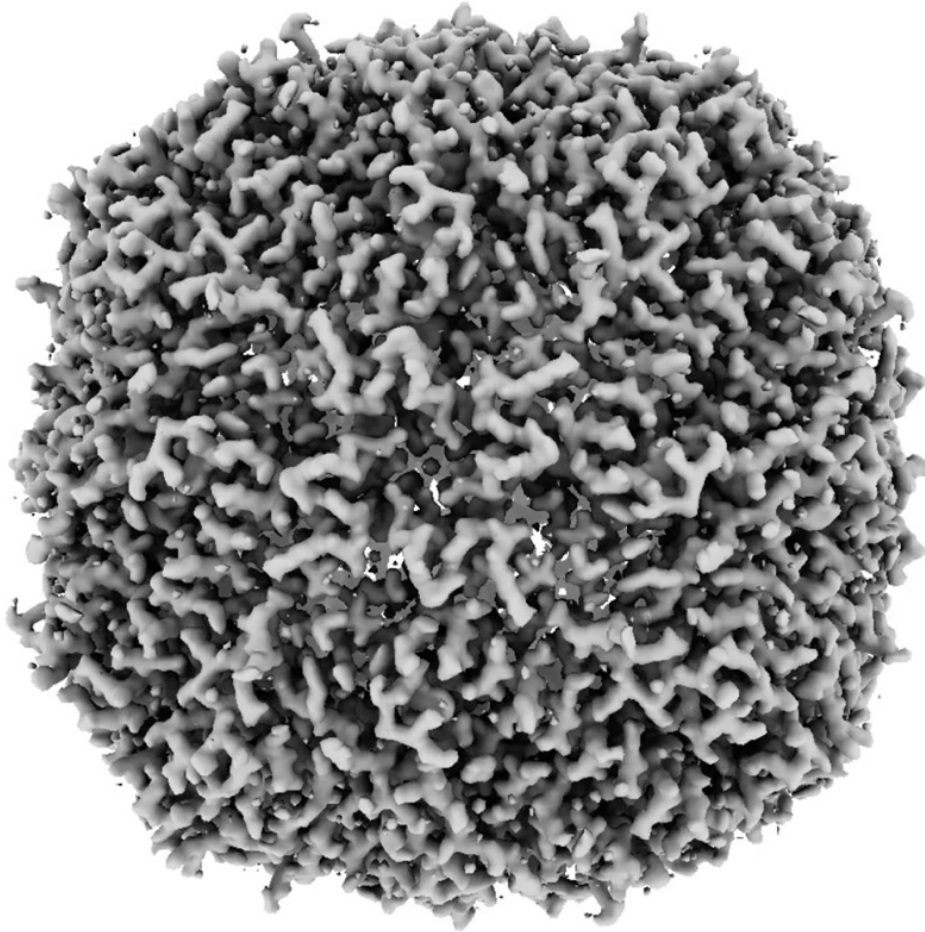
- The background noise around the particle is used in later analysis so enough must be available for this.
- The particle is often not central in the square so there needs to be enough background on all sides.
- The defocus means that high-resolution signal can be delocalized far outside the obvious particle boundaries
- Making the box too big leads to unnecessary computing at later stages of the analysis.
- Generally, the length of the side of the box should be 50% larger than the diameter of the particle.

## 2D classification

---

The problem with particle picking, no matter what algorithms are used, is that many junk particles and even non-particles have been selected. This step is an ideal way to clean up the data before further analysis. Only the best quality images showing a range of different particle orientations, should be included or the resolution of the 3D maps will be greatly reduced.

The idea is to group together all similar images of particles into specific groups or classes. This should take into account, orientation differences as a result of x and y translation and also rotation. SPA programs are designed to find both compositional and conformational differences and identify the images that are somewhat similar to each other, and that are present in high enough numbers to justify the creation of specific classes. All the images within the class are then averaged to give a single representative image with good SNR relative to the original raw images.



Checking of these class images provides an excellent way to evaluate the quality of the data. It can show:

1. if there is heterogeneity in the sample, from contamination, a breakdown product or alternate conformations.
2. the presence of contamination like ice that may have been identified as particles
3. if there is enough information to accurately distinguish orientations.
4. enough 2D classes to show well-resolved features
5. if a wide range of orientations are represented so that a high-resolution 3D map is possible. If certain orientations are underrepresented it may be necessary to go right back to the preparation of new vitrified samples looking for ways to ensure the sample contains particles in all orientations.
6. poor classes that should be disregarded. This is good way to clean up the dataset and large numbers of particles are usually removed.

While this evaluation can be valuable for cleaning up the dataset it can often mean that the original sample preparation is not good enough and the entire dataset should be discarded. When a new sample is prepared, look at new methods of preparation to overcome the problems.

Performing multiple rounds of iterative 2D classification can refine the classes and clean up the dataset even further.

## 3D reconstruction

---

The first consideration before starting the 3D reconstruction is whether there are actually enough particles to achieve a reconstruction at the desired resolution. The Crowther equation gives a good approximation.

$$N = \pi \frac{D}{d'}$$

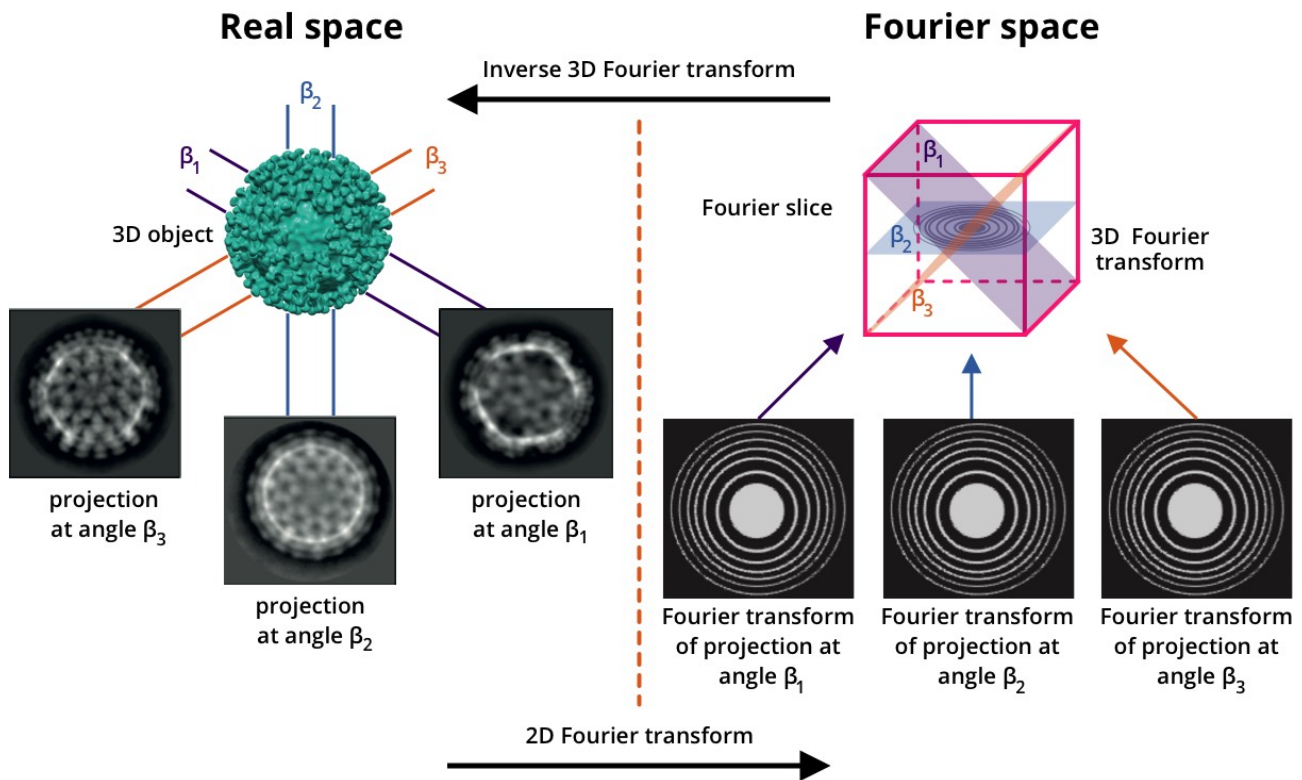
$N$  is the number of particles (or minimum number of unique projections needed),  $d$  is the resolution and  $D$  is the diameter of the particle. This could also be presented as

$$\Delta\theta = \frac{d}{D}$$

$\Delta\theta$  is the angular increment between the orientations. The size of tilt angles between the successive orientations will prescribe how well the 3D reconstruction will be covered. Missing orientations means a less complete 3D Fourier transform and so poorer resolution in those particular regions of the reconstructed map. This is a rough estimate as many other factors influence the resolution.

There are 2 main approaches for the 3D reconstruction

1. Projection-matching alignment. This is based on the Central Section or Fourier Slice Theorem. Basically, the Fourier transform of a single 2D projection of a 3D object is a central section through the 3D Fourier transform of that object perpendicular to the direction of the projection. Images of the object in many different orientations provides lots of different central sections. Combining all of these 2D Fourier transforms together gives a 3D Fourier transform and a 3D inverse Fourier transform of this will produce a reconstruction of the original object. This involves determining the orientations of all the projections in the dataset by comparing against a known model 3D map. The model can come from a low resolution negative stain derived reconstruction, an X-ray model or an EM map of a homolog and should be low resolution to avoid introducing any bias.



*Central Section Theorem. The 2D projections from particles in different orientations are converted to 2D Fourier transforms. Combining all the Fourier transforms from all the orientations produces a 3D Fourier transform. Performing an inverse Fourier transform on this will produce a 3D image of the object in real space. Figure courtesy of Lou Brillault, University of Queensland.*

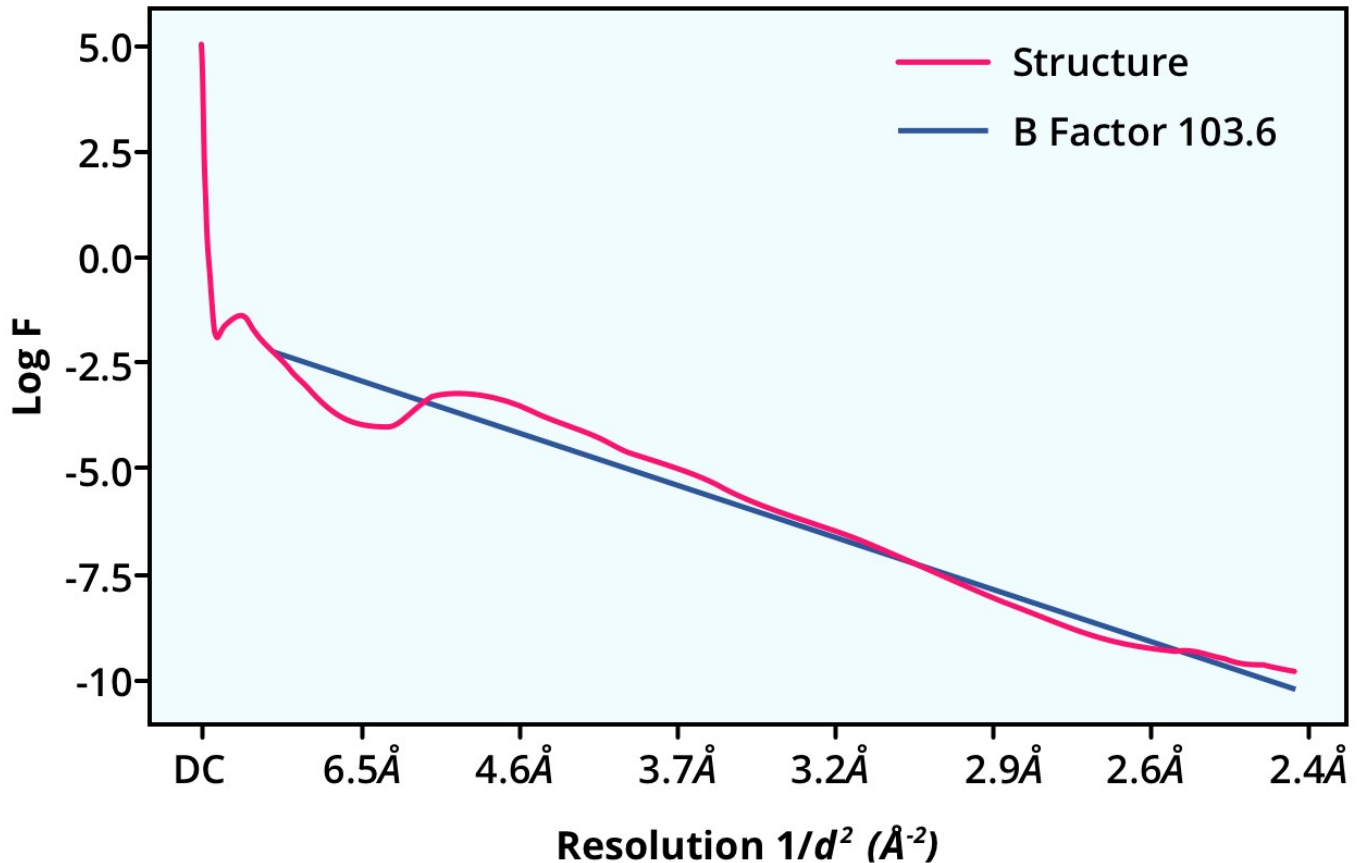
2. Maximum likelihood methods. These do not need a model to compare against for the initial orientations but consider all possible orientations of the particle and assign weights to each direction according to their probability. It finds the most likely 3D reconstruction for the dataset by maximising the probability that the observed particle images would be generated, given the cryo-EM reconstruction produced during the refinement. The maximum likelihood approach is best for data that has high levels of noise, like cryo-TEM data.

Both techniques produce new maps that could be of low resolution, between 20 to 60Å, that serve as a new reference structure for the next round of alignment. This process keeps cycling to produce improved higher resolution maps each time. The iterations continue until there is no improvement in reconstruction resolution at what is called convergence.

3D classification of the maps helps again to evaluate the quality of the data, often showing heterogeneity that wasn't obvious in the 2D classification and leading to the removal of more particles from the dataset. It may also indicate missing orientations or a favoring of specific orientations that could bias the models. This could mean preparation of new samples, trying to avoid the orientation issues.

The signal in the final 3D reconstruction is dampened at high frequencies due to many issues both during imaging in the microscope and during the image processing. The measure of each of these signal losses is an attenuation envelope. There are many envelopes that lead to deterioration of the data and they can include things like optical imperfections in the imaging system, the thickness of the ice and noise-induced errors in averaging alignments. It is possible to determine an aggregate envelope function that encompasses all of these elements. This is described as the "B factor". The B-factor is really a number estimated from the data that tells you about the rate at which the signal-to-noise ratio deteriorates, relative to resolution (or spatial frequency). The 3D map is sharpened by applying a negative B factor to each Fourier component to counteract these effects. The B factor can help to guide the reconstruction as it can be used to give a more accurate estimate of how the resolution will improve with an increased number of particles. It can be estimated from the slope of a Guinier plot which graphs  $\log F$  (the log of the amplitudes in the three-dimensional Fourier transform squared) against the inverse of the resolution squared for each refinement. At a very simplistic level,  $\log F$  can be considered as representing the amount of signal in the data. The B factor can also be measured using the slope of a Rosenthal-Henderson plot which also graphs the inverse of the resolution squared for each refinement but against the logarithm of the number of particles in the corresponding subset.

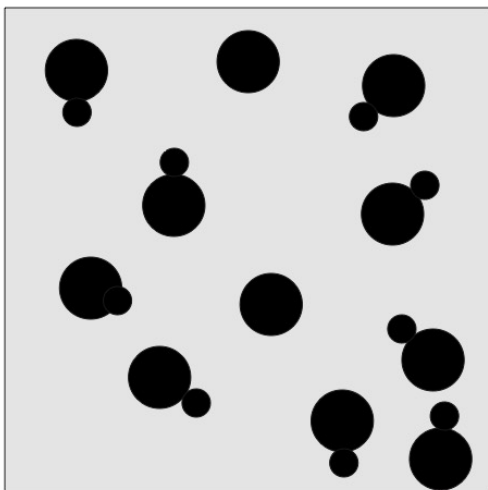
## Guinier Plot



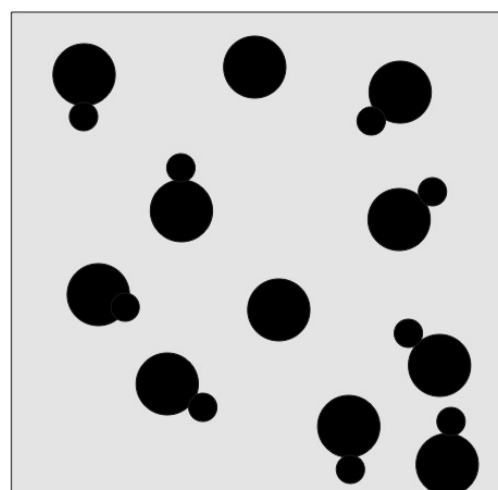
A Guinier plot of data from a refinement of apoferritin. The slope of a straight line fitted through the data gives the B factor.

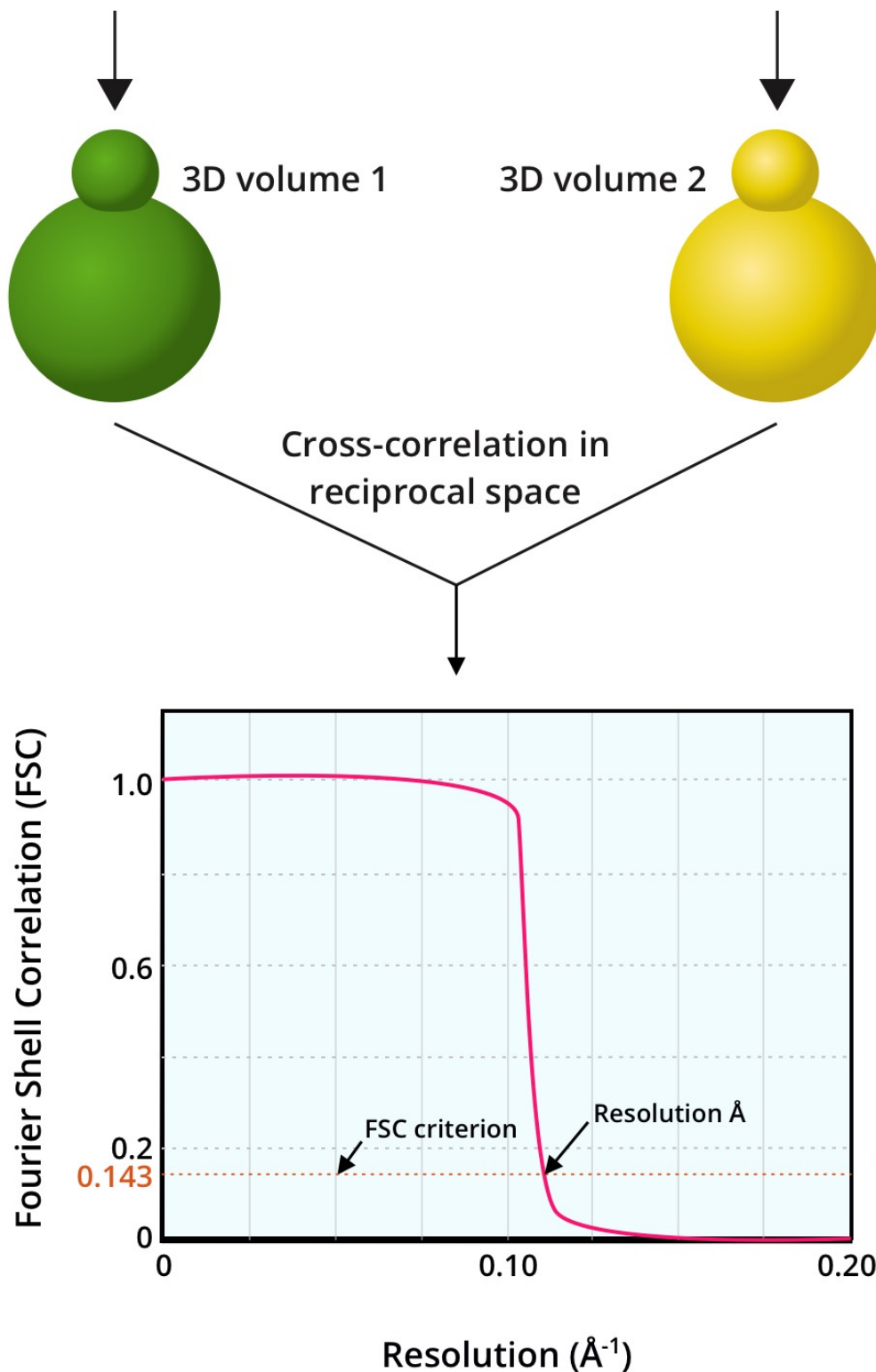
Typically, the global resolution of maps is measured by a “gold-standard” procedure. This involves splitting the original data into two halves and independently refining each to produce two reconstructions. A comparison between these two maps is done in 3D Fourier space. A correlation between corresponding Fourier shells (spatial frequencies that are the 3D equivalent of Thon rings) in reciprocal space is produced. This is called the Fourier Shell Correlation (FSC). The average value for all shells are plotted as a curve with the correlation on the Y-axis and spatial frequency on the X-axis. The FSC is really a measure of the SNR of the map, so a correlation of 1 is a perfect correlation with no noise while 0 represents no correlation or just noise at the spatial frequency. The spatial frequencies are measured in the units of  $\text{\AA}^{-1}$  which is a direct reciprocal of  $\text{\AA}$  so this can be used for reading the resolution of the maps. The cryo-EM community has now accepted that the value of 0.143 is the threshold for reading the resolution as seen on the example graph.

Half data set 1



Half data set 2

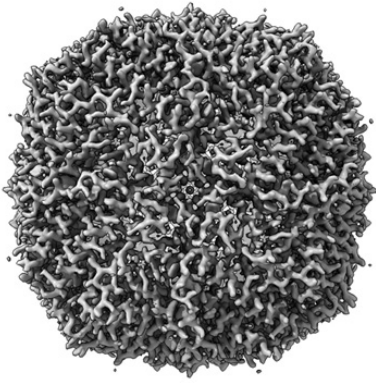
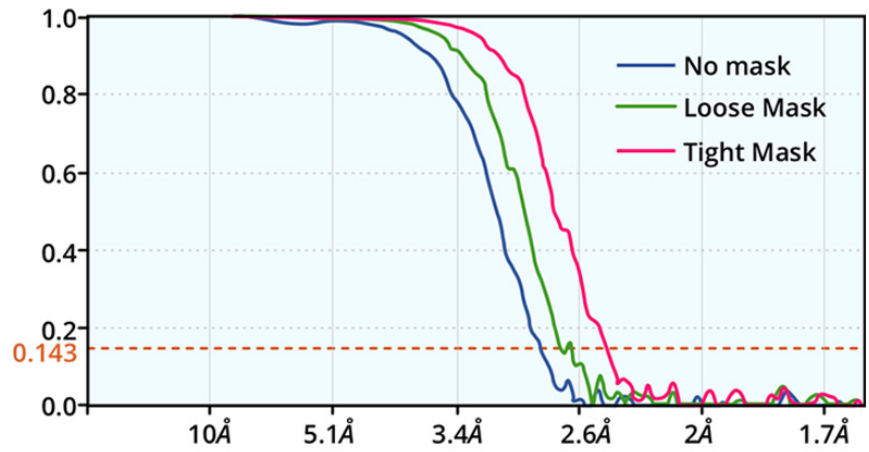




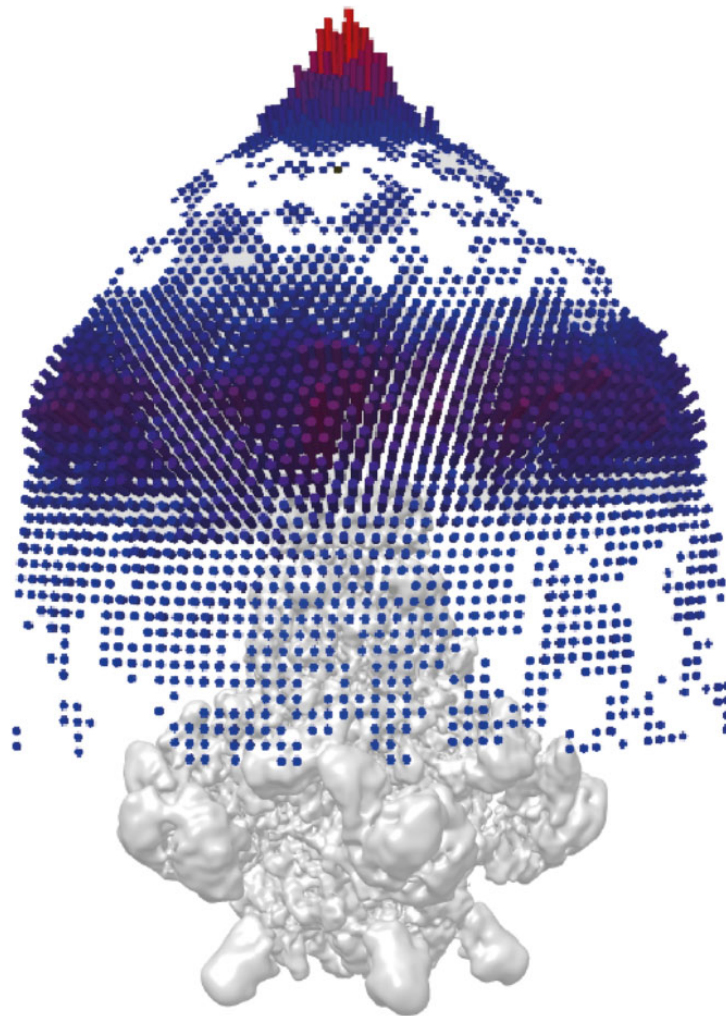
*Gold standard of map refinement. The dataset is divided into 2 half sets and the 3D reconstruction is done on each. A Fourier shell correlation between the 2 shows the resolution of the map at the value of 0.143. Figure courtesy of Lou Brillault, University of Queensland.*

3D refinement of models is a very complex process and many different strategies have been adopted to address specific issues. For one thing the resolution of different regions of the model can be quite different and so specific refinement of the region is necessary. One way to address this is to apply a soft 3D mask on the specific part, so the classification will be focused solely in that area.

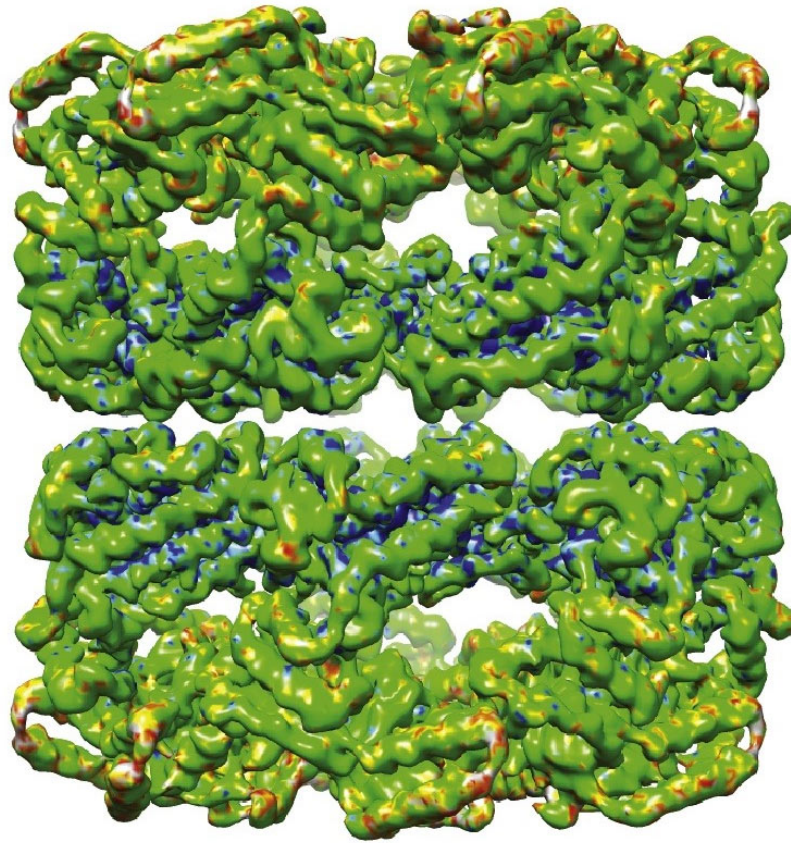


**A****B**

FSC graph for an apoferritin map showing the resolution for the map with no masks used, a loose mask and a tight mask during refinement. The resolution is read at the 0.143 correlation.



Angular distribution plot showing the particle orientations contributing to the final map (red: high occurrence, blue: low occurrence). From such a plot it is possible to tell if certain orientations are under-represented in the map. This is from a reconstruction of the pore-forming A subunit from the Yersinia entomophaga ABC toxin and is overlaid on a map of this. Image courtesy of Michael Landsberg, University of Queensland.



*Map of GroEL rendered according to local resolution. Blue indicates the highest resolution regions and red the lowest resolution regions.*

# Validation

---

Map validation is to ensure that the 3D map you've created really is a true representation of the original sample, it's like a quality control. While this is often the final step of the process, the 3D reconstruction refinement itself should also be guided by the validation measures to ensure that the map is continuously improving at each iteration.

The true validity of a map is judged by whether it contains high-resolution features that are expected for the macromolecule of interest. Are there features that look like  $\alpha$ -helices or are there densities for side-chain residues where they are expected to be seen? Of course, this should be done with respect to the resolution of the constructed map. The map is validated against the atomic model for the macromolecule predicted from its genetic sequence. This may in itself not be accurate and the model itself can be improved through validation.

This can be tested in many ways:

1. producing a large number of independent reconstructions using the same method to improve convergence
2. comparing the results produced by different methods to check for consistency
3. verifying that the resulting reconstruction has the expected features, particularly the secondary structure
4. fitting of known sub-structures from other methodologies.

## Sub-tomogram averaging

---

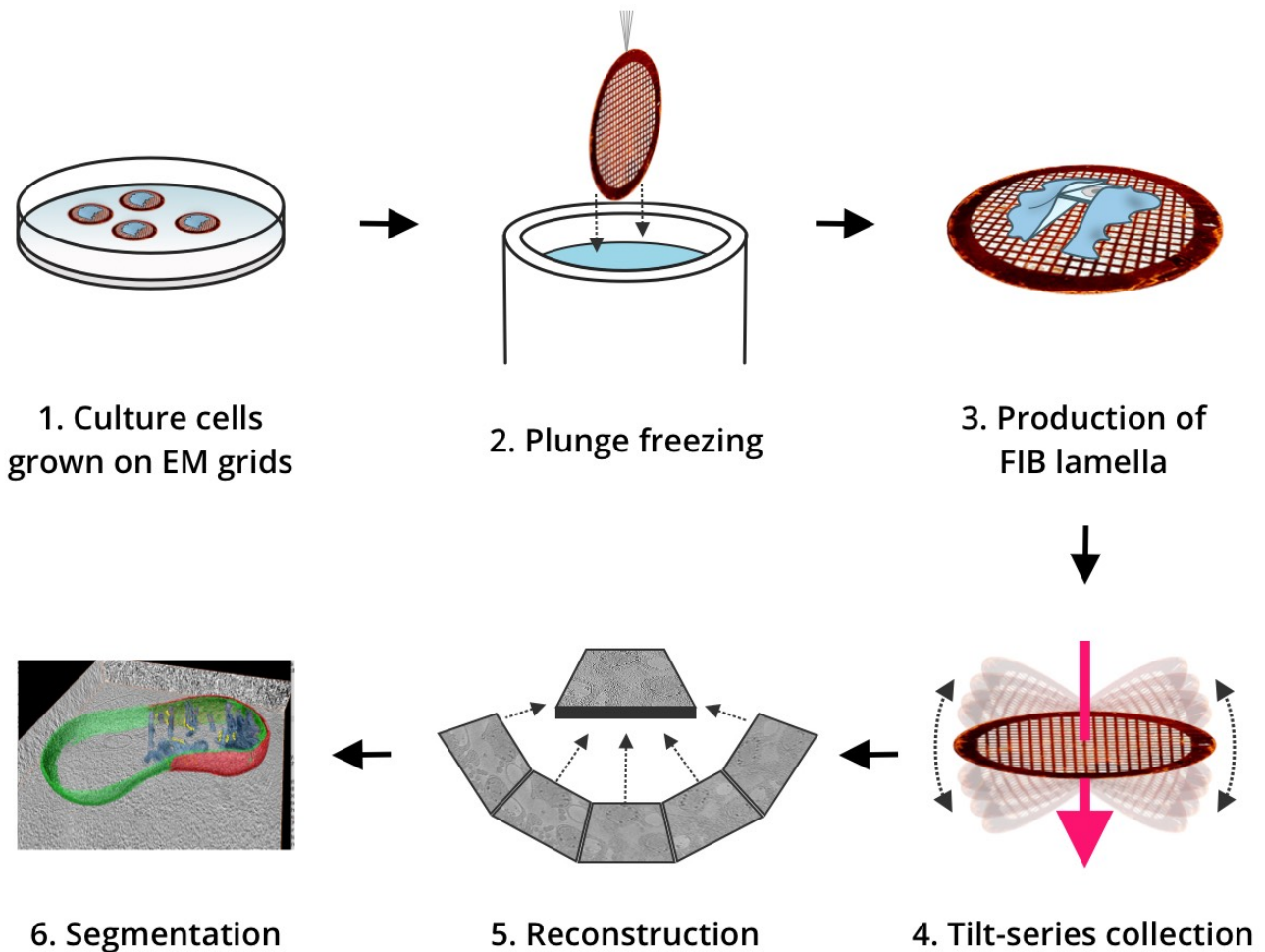
While SPA techniques are usually used for studies on purified particles, sub-tomogram averaging has found some use in helping to refine 3D reconstructions. This involves obtaining tomograms that are 3D reconstructions made from images collected by tilting a cryo protein sample through a range of angles. Sub-tomograms of the individual particles of interest are extracted, aligned and averaged to improve the SNR and the high-resolution 3D structure. The sub-tomograms are 3D volumes rather than the 2D projections in SPA.

It is not a widely used technique for analysing purified particles. However, it has been used for generating models to be used in SPA. Potentially there is more information in the tomogram than in a single 2D projection so it could prove to be more useful. Recent studies utilising new sub-tomogram averaging software that particularly address issues related to sample motion and deformation have produced  $<4\text{\AA}$  resolution of particles in situ in a cell and 2–4 $\text{\AA}$  for isolated particles.

# Cryo-tomography (cryo-ET) - Introducing cryo-electron tomography

Cryo-electron tomography (cryo-ET) is a technique that reconstructs 3D information from a sample. Unlike SPA this is usually performed on larger samples, isolated particles like viruses or bacteria or eukaryotic cells. The power of the technique is that cellular ultrastructure at a range of resolutions can be achieved so that it bridges the gap between the cellular and the molecular structural resolutions.

The frozen samples are tilted through a range of angles so a series of 2D images are captured that can be computationally combined to produce a 3D reconstruction. This is similar to a CT scan except that here the sample is being tilted rather than the beam source.



*Workflow for cryotomography of cells.*

- 1. Cells are grown on gold grids.*
- 2. The grids are plunge frozen in liquid ethane.*
- 3. Using the FIB the ROI in the cells is thinned into a lamella.*
- 4. The tilt series of images is collected in the cryo-TEM.*
- 5. The tomogram is reconstructed from the images in the tilt series.*
- 6. The structures of interest are delineated from the dataset by segmentation*

The technique offers many advantages

1. As with all cryo-EM techniques imaging is performed on vitrified samples so the structure as near as possible to the native state.
2. It puts the structures into a cellular context, giving the relationship of organelles to one another, plus information on molecules within their cellular environment.
3. It can reveal different structural and functional states of large protein complexes within the cellular environment

However, it does suffer from certain limitations

1. As with all cryo-EM techniques the sample suffers from radiation damage, so imaging must be done using low dose parameters, meaning that SNR is poor. The electron dose per tilt image is even lower than in SPA.
2. As in SPA, the signal is produced mainly by phase contrast, meaning that image restoration is needed to retrieve the real information.
3. Only thin samples can be used, usually <500nm when using a 300kV TEM, meaning only small samples can be studied or thicker samples must be thinned down.
4. The sample must stay at the centre of the images during data collection so that it is possible to align all images in the tilt series.
5. Due to constraints of the microscope and holder  $\pm 90$  degrees of tilting is not possible. In practice it is usually only possible to get to  $\pm 60$ –70 degrees meaning that some data is missing. This is called the missing wedge.

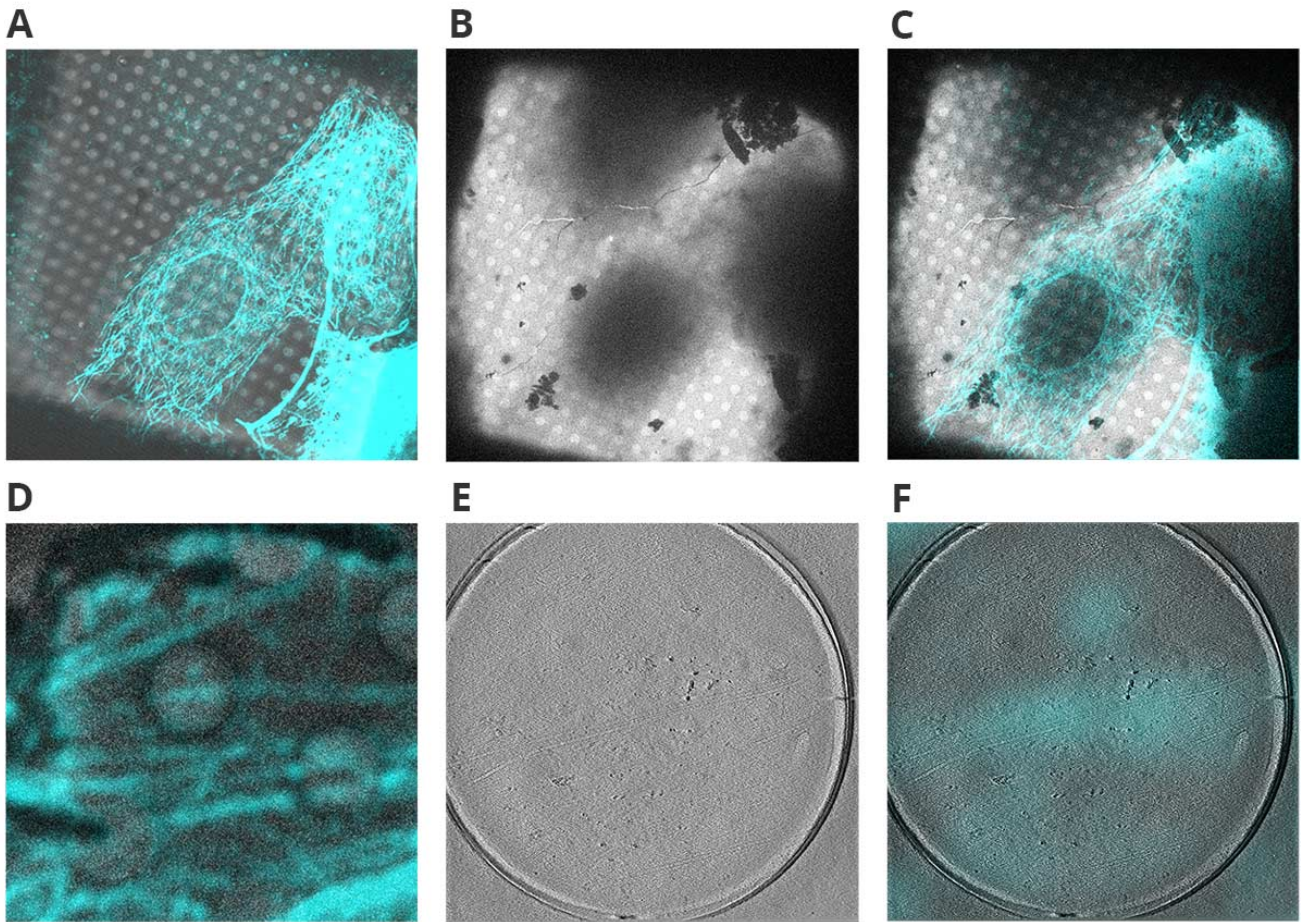


*Image from a cryo-tomogram of a Ptk2 cell showing abundant endosomes, multivesicular bodies, cytoskeletal elements including actin and microtubules, ribosomes and some endoplasmic reticulum. The cell is sitting over a hole in the carbon film. Image courtesy of Nick Ariotti, University of New South Wales.*

Within a cryo-tomogram high-resolution molecular structures can also be elucidated, using sub-tomogram averaging. Small subvolumes containing a structure or molecule of interest are extracted from the tomogram, aligned, averaged and through iterative processes, a 3D reconstruction at high-resolution, <1nm, is obtained. The section on Sub-tomogram Averaging describes this in more detail.

Unfortunately, because of the larger cellular volume it can be difficult to locate the structure of interest. Correlative

microscopy using cryo-fluorescence light microscopes can aid in this process. The signal from proteins of interest tagged with a fluorescent probe can be imaged in the cryo-light microscope and this image overlaid onto the TEM images to precisely identify the region of interest.



*Cryo-CLEM. A. A ptK2 cell imaged with a cryo-fluorescence light microscope. The cell is expressing the fluorescently labelled microtubule associated protein, EGFP-DC. B. Cryo-TEM image of the same cell. C. Image A is overlain on image B so the location of the microtubules can be seen within the cell. D. Higher magnification image of the same fluorescence within the cell showing regions of the cell which are lying over holes in the supporting carbon film. E. higher magnification cryo-TEM image of a cell lying over a hole in the carbon film. F. Cryo-fluorescence light microscope image overlain on a cryo-TEM image identifying the relevant regions containing the microtubules of interest. Images courtesy of Nick Ariotti, University of New South Wales.*

# The TEM for cryo-ET

---

Most modern cryo-TEMs are capable of acquiring cryo-ET data but there are several specific requirements

1. A 300kV field emission cryo-TEM. As the samples are relatively thick and as they become thicker relative to the electron beam during tilting to high angles, a high voltage microscope of 300kV is necessary. The higher voltage gives a greater penetration depth (mean free path for inelastic electron scattering) of the electron beam with less electron scattering. This increases two-fold between 100 and 300kV.
2. An energy filter as described in the SPA section is necessary to improve the SNR of images by removing the inelastically scattered electrons.
3. A very stable and well calibrated stage that will tilt to angles of  $\pm 60$  degrees or greater.
4. A direct electron detector operating in dose fractionation mode as used in SPA studies is required to improve the SNR and correct for image drift.
5. The appropriate software to control the microscope operations during the capture of the tilt series. This is a relatively complex operation controlling many parameters during the acquisition of the tilt series.



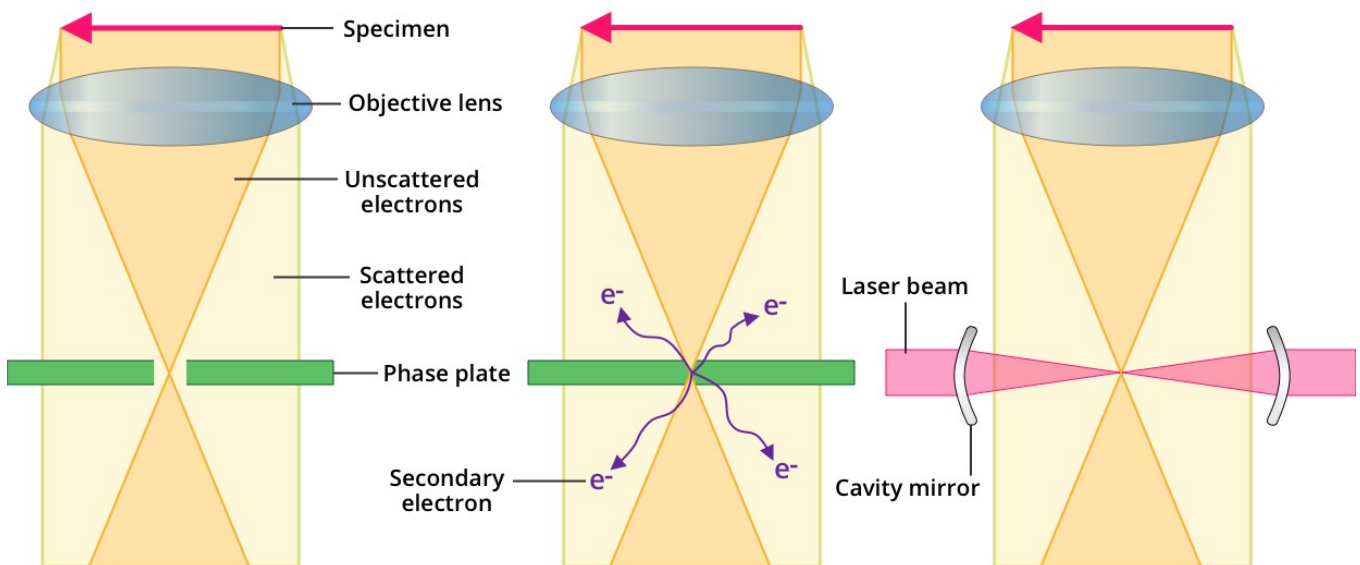
*A 300kV CryoTEM. Image courtesy of Georg Ramm, Monash, University."*



# Phase plates

An alternative to the defocus-based methods for improving image contrast is the use of phase plates. Three types have developed to improve image contrast.

1. The simplest is the Zernike phase plate which is a thin film of amorphous carbon with a small central hole that is placed at the back focal plane of the objective lens. This allows the non-scattered electrons to pass without phase shift creating a relative phase change between the transmitted wave and scattered waves from a specimen, leading to enhanced contrast in the image. Unfortunately, over time these easily degrade due to contamination, and so need to be changed regularly. They also produce fringe artefacts in the images and are difficult to use because of alignment issues.
2. The most commonly used is the Volta Phase Plate (VPP), is a hole-free thin film of amorphous carbon is also mounted at back focal plane. This thin film plate is electrically charged creating a change in electrostatic potential, causing a phase shift in the unscattered transmitted wave relative to the scattered waves. Being hole-free the Volta phase plate doesn't suffer from the problems associated with the Zernike phase plates.
3. The laser-based phase plate involves use of mirrors to amplify a laser beam tens of thousands of times and to use this to cause the phase shift. As there are no physical materials in the electron beam path there will be no information loss. These are still in their development but show great promise for the future.

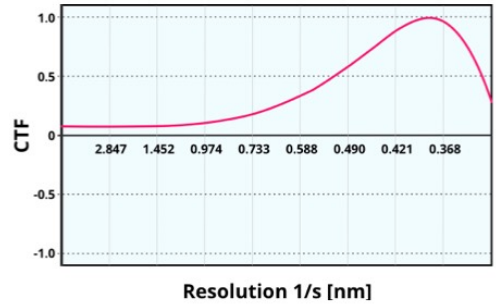
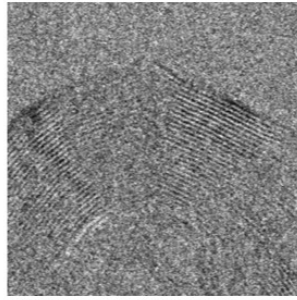
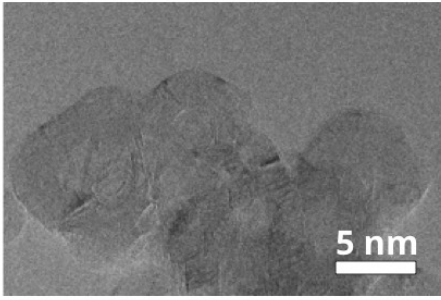


Comparison of the types of phase plates. A. Zernike phase plate which utilises a hole in a carbon film to produce the phase shift. B. The Volta phase plate where the phase shift is produced by electrical change in the film. C. laser-based phase plate. The intense laser beam causes the phase shift. After [JEOL](#).

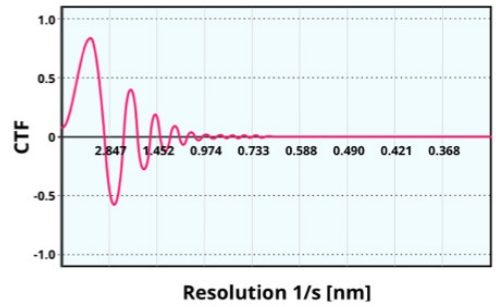
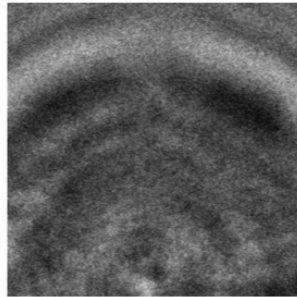
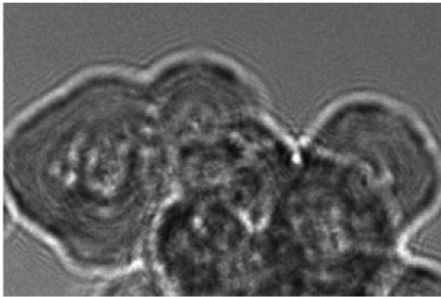
As it is impossible to achieve perfect focus at all regions, a small amount of defocus must still be used, which can be determined during data processing.

The limited defocus with phase plates makes contrast-transfer-function fitting and correction difficult. For the VPP the carbon film itself causes electron scattering and there is a loss of signal of around 20% across all spatial frequencies. However, the contrast enhancement is valuable and often the only way to visualise small features in the tomograms. Therefore, many cryo-ET studies that use sub-tomogram averaging use phase-plate imaging. While initially used for SPA of small particles and cryo-tomography to improve contrast, it has now been shown that the use of VPP does not help to achieve better resolution and their use is becoming less common, especially for high resolution studies. However, the new developments in this area are generating a lot of interest so they could be a more valuable tool in the future.

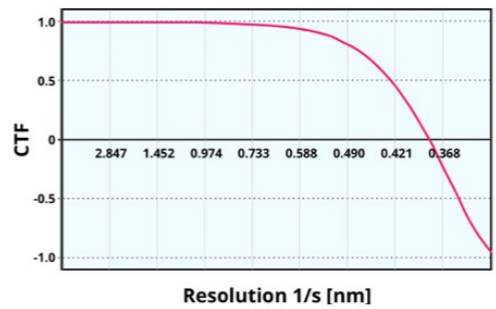
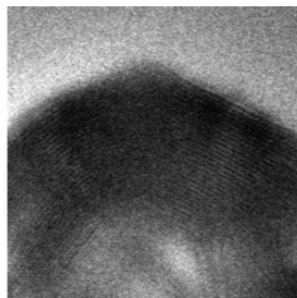
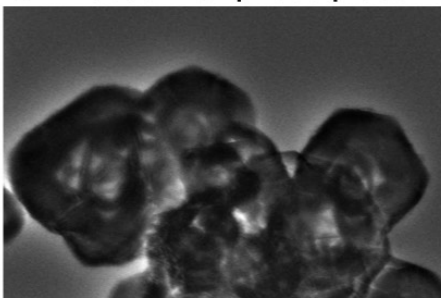
### A. In focus



### B. -5 $\mu$ m defocus



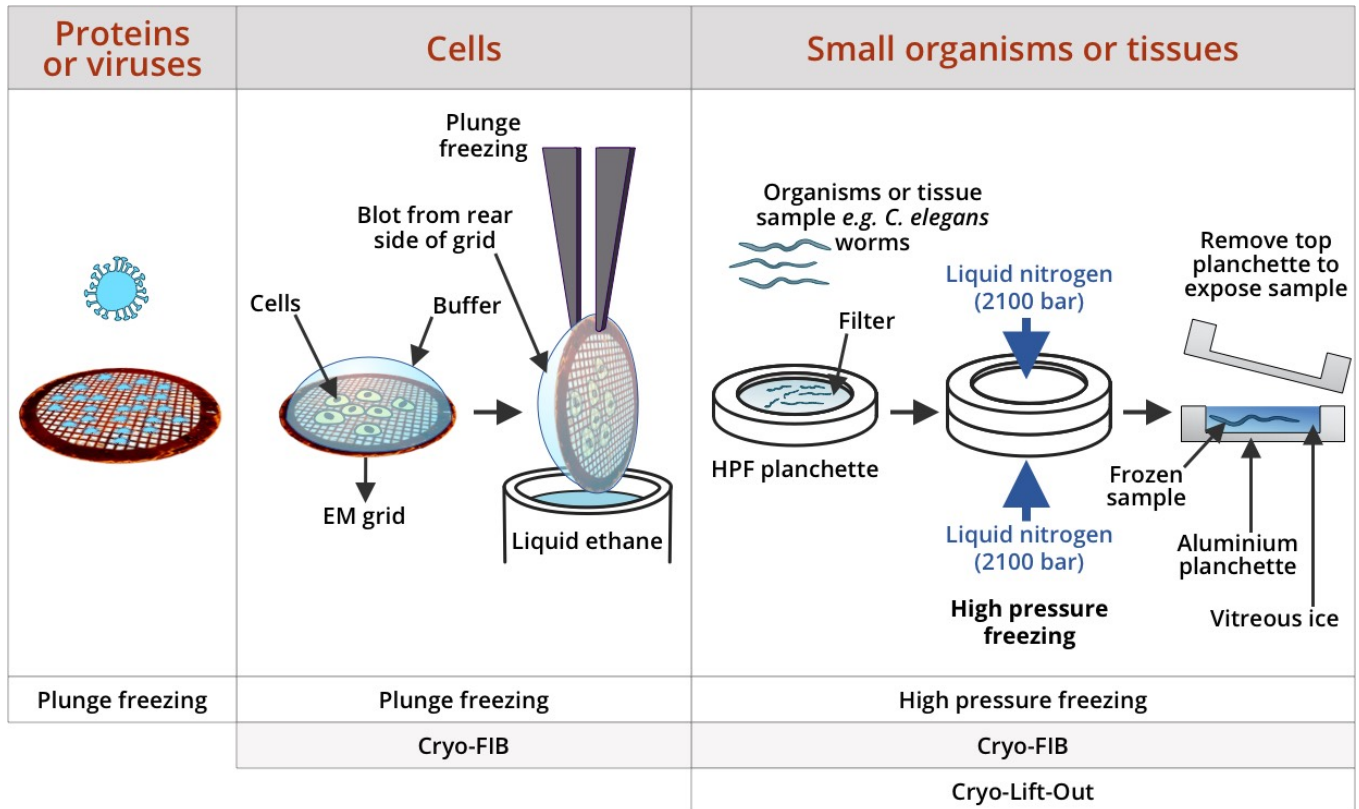
### C. In focus with phase plate



Carbon black observed A. in focus B. with -5 $\mu$ m defocus and C. in focus using a Volta phase plate. The CTF for each are simulated. The use of the phase plate increases the contrast in the image but the shape of the CTF for the in focus images makes image correction more difficult. Images courtesy of Georg Ramm, Monash, University.

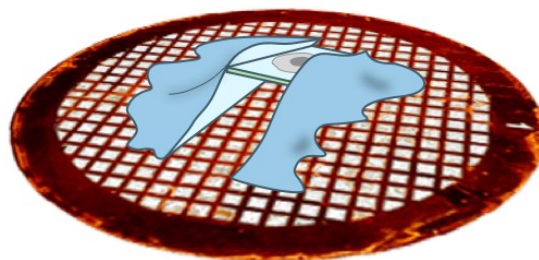
# Sample preparation

As stated earlier, samples for cryo-ET need to be thin: <500nm in thickness. Small samples, such as virus particles, whole bacteria and mammalian cells are vitrified in a manner similar to that described for SPA, where they are plunged into liquid ethane. The cells are grown directly onto gold grids or a suspension is deposited onto a grid prior to freezing. Colloidal gold can be used as fiducial makers for tilt series alignment and is added to the sample directly prior to the blotting. Grids are blotted from the backside as touching the blotting paper can cause the cells to rupture or be pulled off the grid. Thicker tissue or whole organism samples are vitrified by high pressure freezing.

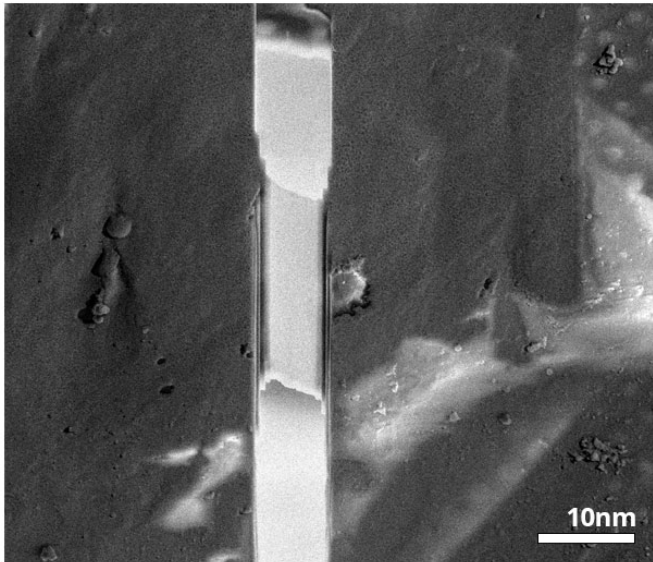
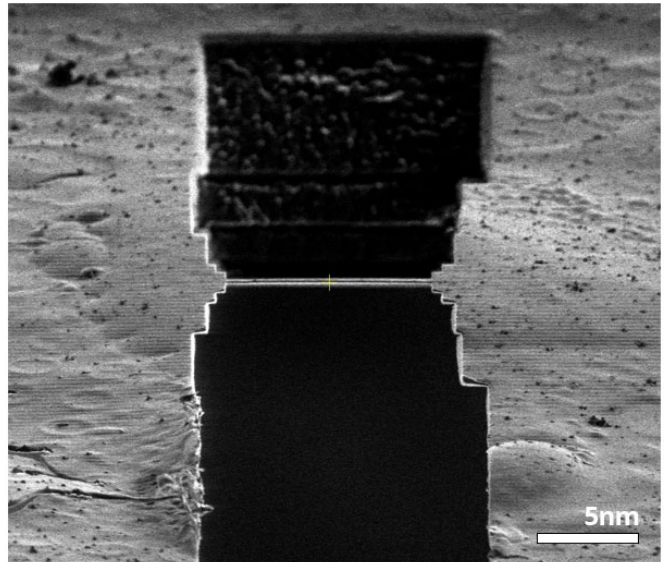


Types of sample vitrification for cryo-tomography.

Samples, like viruses and bacteria, are thin enough to be imaged directly in the TEM. Some regions of mammalian cells are also thin enough, particularly around the edge of the cells. However, most cells require thinning to make them electron transparent. Cryo-sections cut in a cryo-ultramicrotome (CEMOVIS) have been used for cryo-ET but limitations due to compression artefacts have meant the technique has not been widely used. Cryo-focussed-ion-beam (cryo-FIB) milling, which produces a thinned region of a cell still on the grid is now used for this purpose. Refer to the Cryo-FIB section for details of this process. For the thicker high pressure frozen samples cryo-FIB is also used but a thinned lamella must be removed from the sample and transferred to a specifically designed grid.



Diagrammatic representation of a lamella produced by cryo-FIB thinning of the cell grown on a grid. The ROI within the cell is retained as a lamella approximately 200µm thick, while the region around this is removed using the ion beam. The lamella remains supported by the cell remnants on both sides.

**A****B**

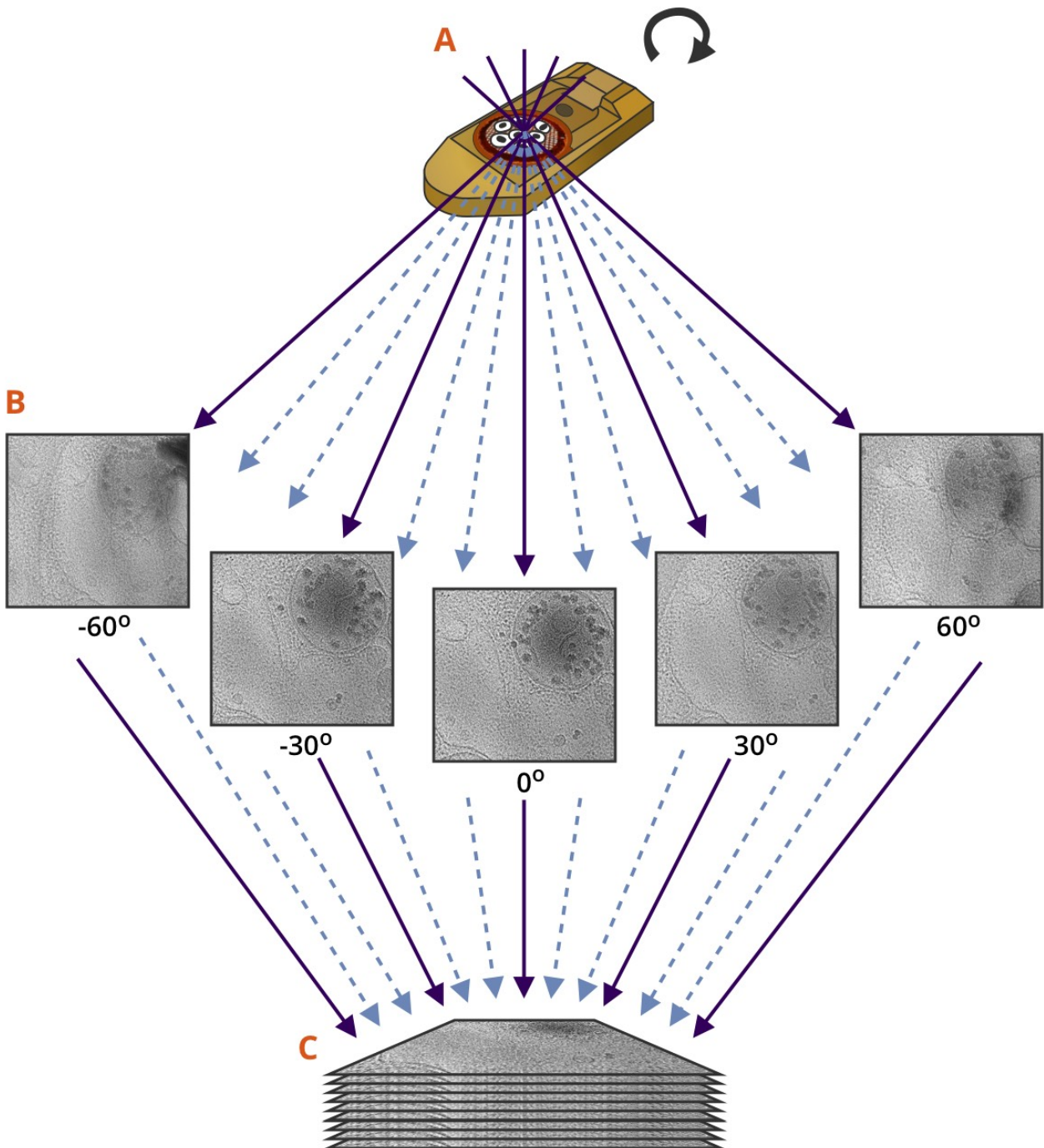
*Images of a lamella produced by cryo-FIB thinning. A. electron beam image. B. ion beam image. Images courtesy of Gediminas Gervinskas, Monash University.*

Cryo-light microscopy can be an important part of the workflow, using correlative localisation information so the ROI can be later found during cell preparation or in the TEM itself.

# Data acquisition

While data acquisition bears many similarities to the procedure for SPA it also has several specific requirements.

The workflow involves acquiring a low magnification atlas of the grid to locate regions of interest. Medium magnification images of specific regions are then used to help identify areas worthy of data collection. Of course, this should be performed with minimal electron dose.



*Image acquisition workflow for cryo-tomography. A. the grid with the vitrified sample is inserted into the Cryo-TEM. B. Images are collected at incremental tilt angles, typically between +60° and -60°. C. the stack of images is then used for reconstruction of the tomogram.*

The collection of the tilt series involves a repeated process of four steps:

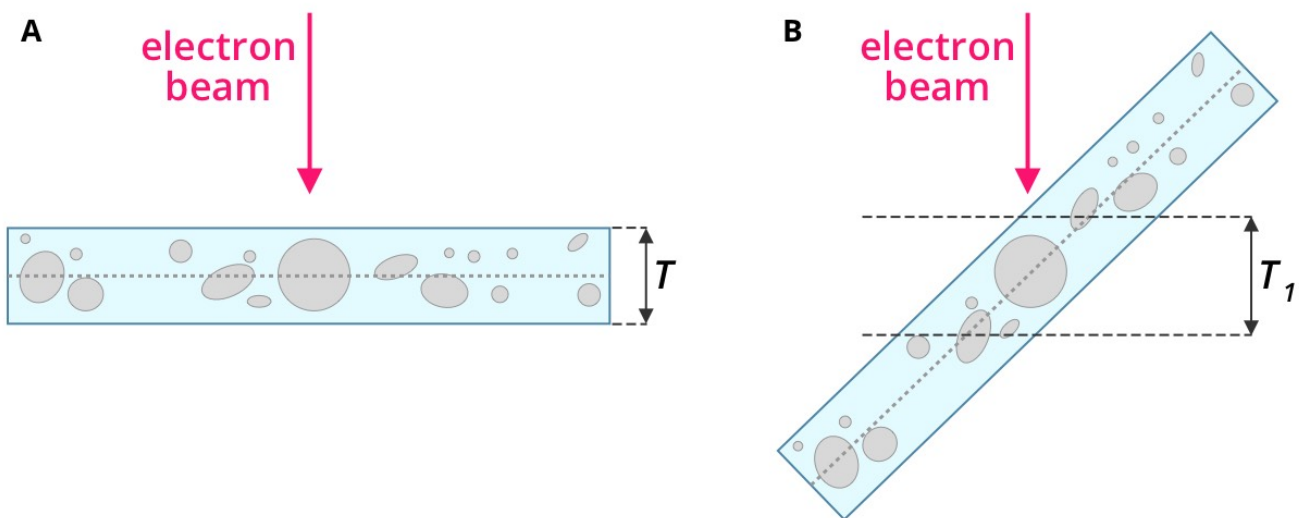
1. tilting
2. tracking/centring
3. focussing
4. recording.

In low dose imaging, tracking and focusing are performed on a separate area to the recording area to reduce beam damage.

Several considerations need to be evaluated in order to set the parameters for the data collection. Before starting a project, it is important to decide on the resolution you need to see the structures being studied. Many basic structural studies need only low resolution but a sub-tomogram-averaging project will require much higher resolution.

**Magnification** – This is directly related to resolution. Increased magnification will give higher resolution by using smaller pixel sizes. As the total cumulative electron dose is given by how many electrons can be used per square Angstrom, at lower magnifications more electrons can be used per pixel, leading to a better signal to noise ratio. Higher magnification also gives a smaller field of view so more tomograms may need to be collected to obtain enough information. The trade-offs are resolution vs field of view and signal vs noise.

**Electron dose** – The total electron dose needs to be distributed over the full tilting range. Different samples can have different sensitivity to electron exposure and this needs to be determined for each sample. Typically a cumulative dose of  $90\text{-}120\text{e}^-/\text{\AA}^2$  is used, which on a typical series of 61 tilts ( $\pm 60$  deg in 2deg steps) will give  $1.5\text{-}2\text{e}^-/\text{\AA}^2$  per tilt image. So the dose per image is very low, leading to reduced SNR. In addition, at higher tilt angles the electrons have to traverse through a thicker sample leading to more scattering which will also give lower SNR. The dose used is 10 to 20 times lower compared to a single exposure in SPA. It is really a compromise between resolution and SNR.



A. Untilted section of  $T$  thickness. B. Tilted section showing the increased section thickness  $T_1$ .

**Defocus setting** – As with SPA this is a balance between less defocus where there is more high frequency (or fine detailed) information and high defocus where there is lower frequency (high contrast) information. Due to the low SNR, in a tilt series defocus is usually set high ( $3\text{-}6\mu\text{m}$ ) to improve contrast.

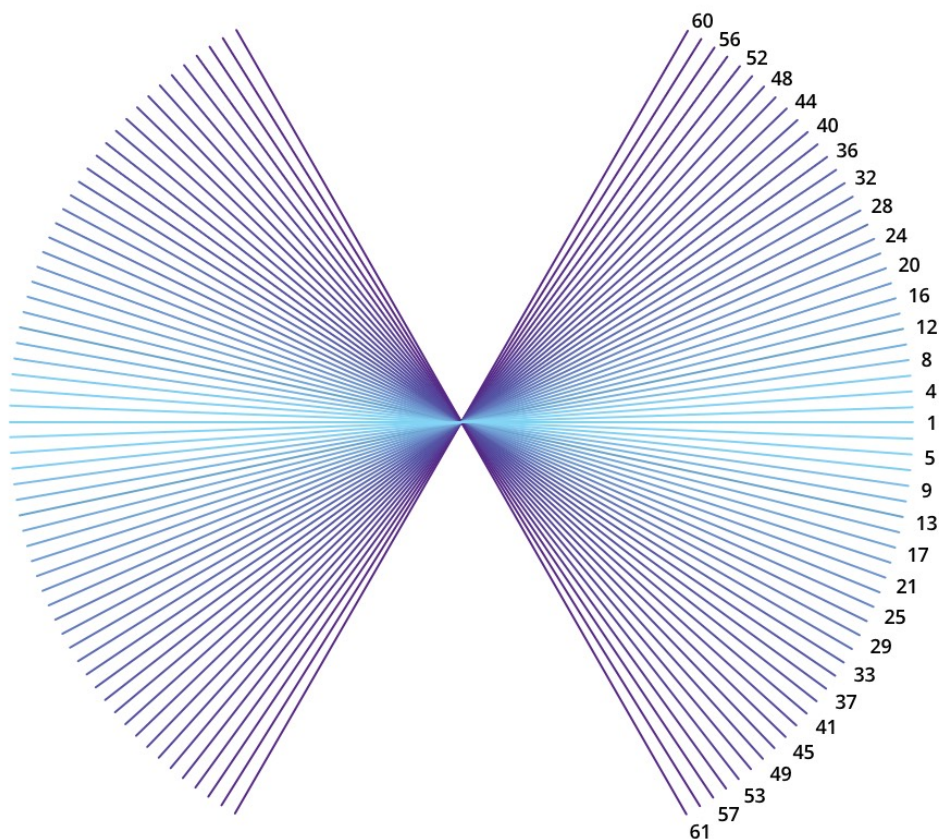
**Tilting strategy** – The tilt protocol consists of three parts that need to be considered:

1. the total range of angles covered
2. the increments between the angles
3. the order in which the tilt images are collected.

The total range covered usually matches the highest available in the microscope,  $\pm 60\text{-}70^\circ$ . Collecting at finer increments between the angles will produce more data, but requires the total dose to be distributed over more tilt images and hence a reduced SNR for each tilt image.

Several different procedures for the order of collection have been used but the most common now is called dose symmetrical. Image acquisition starts in the middle of the tilt range where the sample is not tilted at all and alternates to increasingly higher tilts in both directions, oscillating up to increasing angles. The advantage with collection at low angles first is these contain the higher resolution information compared to the lower resolution information with the increased sample thickness that comes with tilting. By the time the higher angles are collected the cumulative electron

dose will also have damaged the sample. The symmetrical distribution of electron dose minimises the alignment jumps that occur particularly at higher angles.

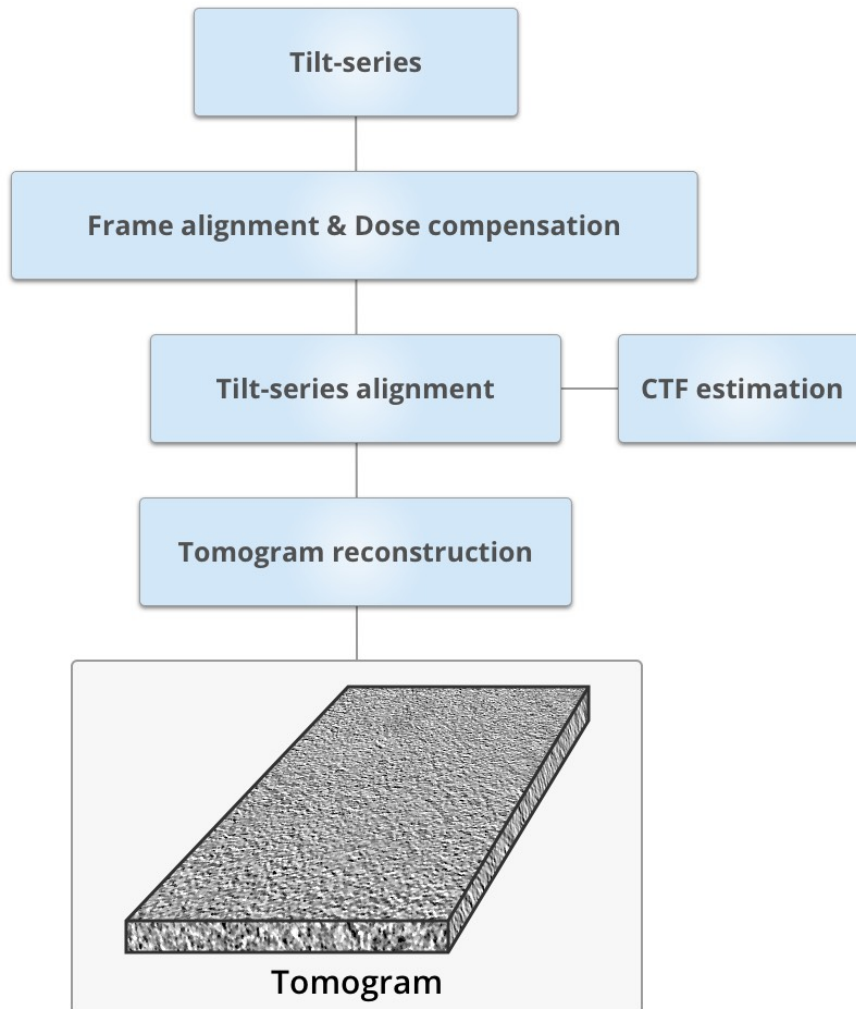


*Diagram showing the order in which the tilt images are collected. This dose symmetric strategy involves alternate collection of images at positive and negative angles starting with the lower angles first. This shows 40 tilt angles collected between  $\pm 60^\circ$ .*

Tilting the sample results in large movements of the sample. This means that there is a need to perform autofocus and tracking of the sample between capturing images. This is done on another region of the sample adjacent to the capture area. This extra step adds time to the collection so often it is only performed every few angle increments. Stages in modern microscopes have improved and tracking may not be necessary in all cases meaning it is possible to collect a full tilt series in less than 10 minutes.

# Tomogram reconstruction

Pre-processing, dose weighting and motion correction procedures correct for the movement and distortions during image collection as well as improving the loss of the high frequency signal. The tilt series images are aligned fully with each other using the fiducial colloidal gold markers that were included in the original samples. However, for samples like cryo-FIB lamellae, where the gold cannot be included in the sample, high contrast features are used for alignment.



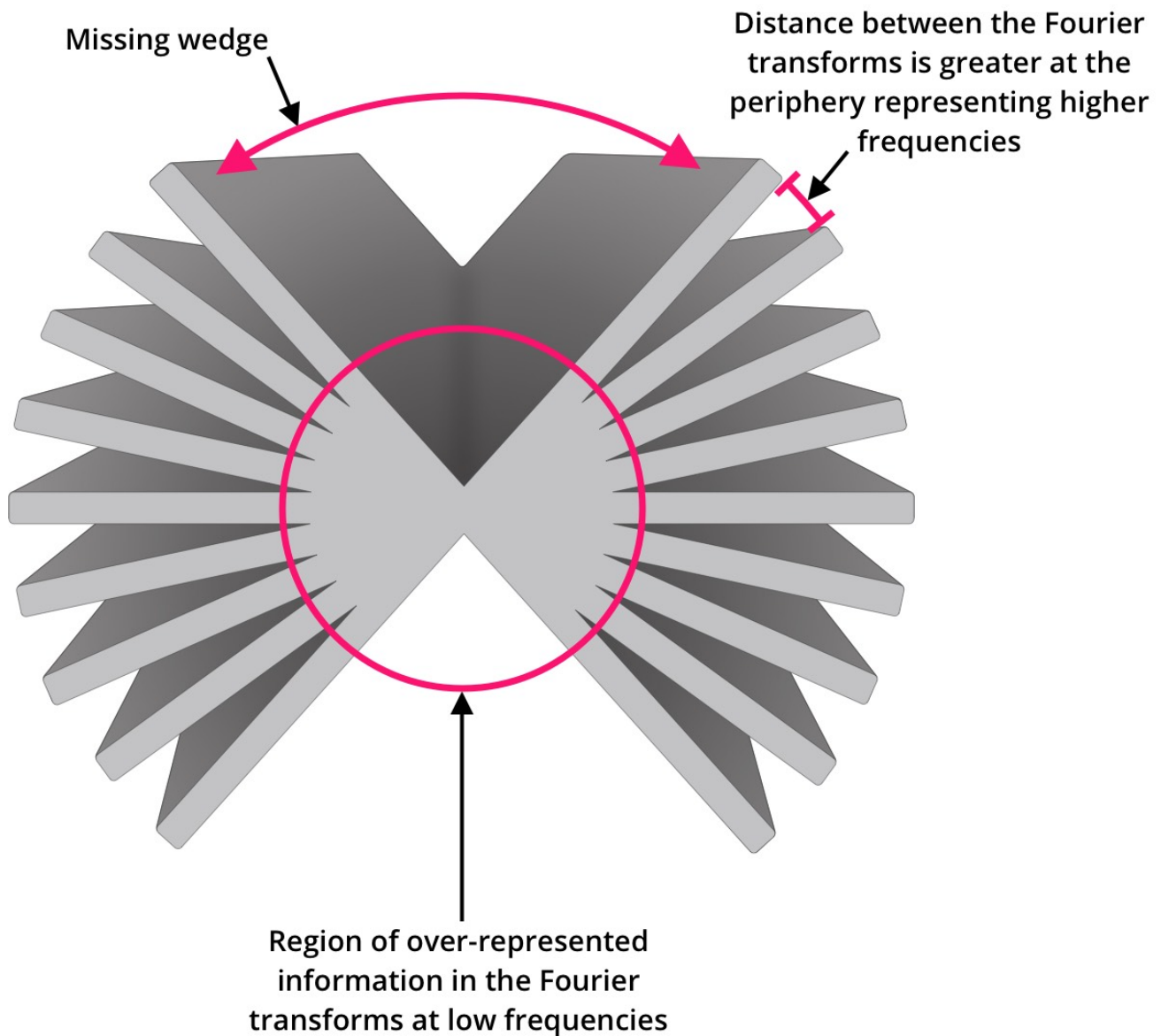
*Workflow for reconstruction of tomograms from tilt series images captured in the cryo-TEM.*

As the imaging is performed using phase contrast from defocussing, it is necessary to perform contrast transfer function (CTF) correction to restore high resolution information in the images. Because of tilting, objects within the sample are at quite different focus, so this makes fitting a CTF difficult. A way to help with this is to divide the image into patches to calculate the defocus gradient perpendicular to the tilt axis.

The data can then be used for the tomographic reconstruction using two main methods:

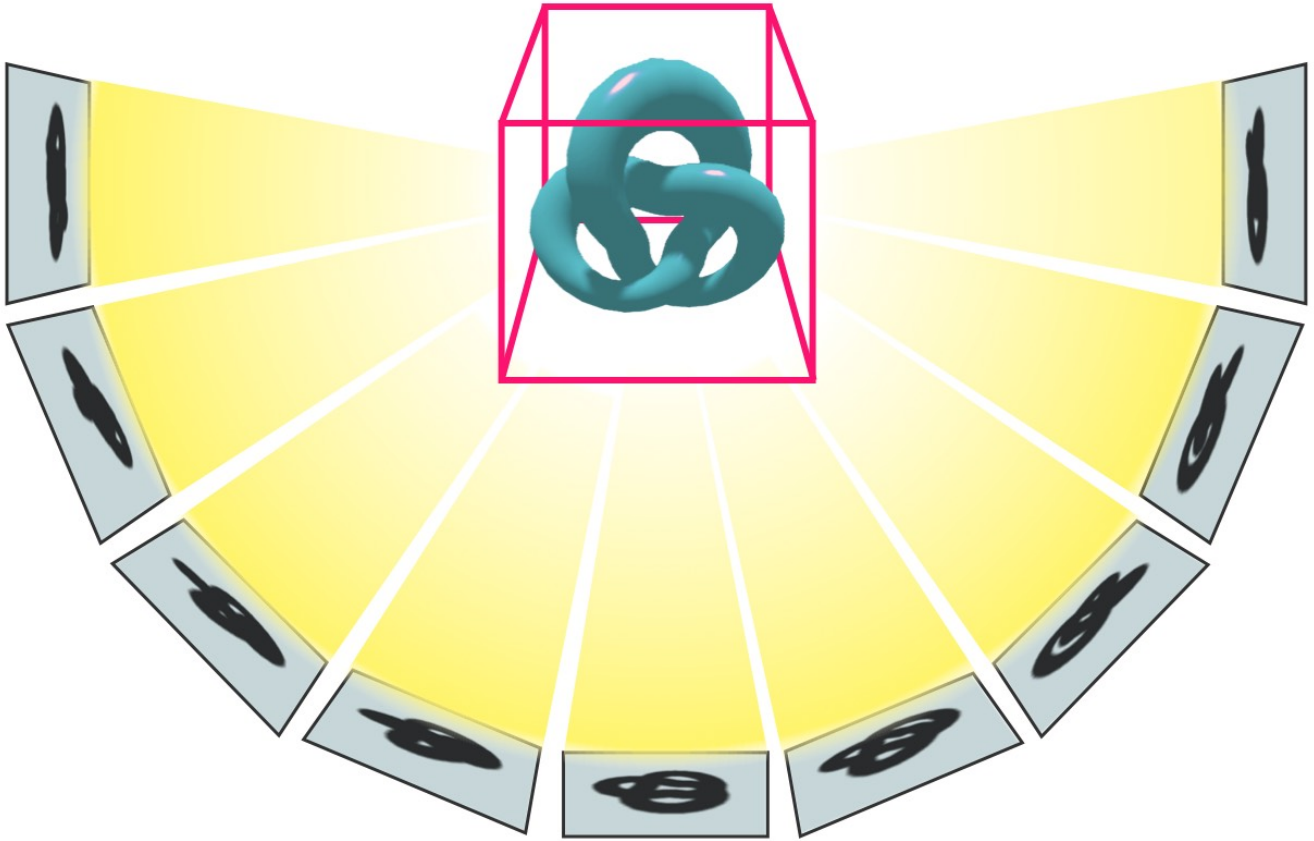
- The simplest method for this is based on the central section theorem as described in the SPA section. The Fourier transform of each 2D projection image is placed into a plane of a 3D Fourier space. Combining all tilts, the 3D Fourier transform is then inverse-transformed to produce a 3D reconstruction of the particle in real space. For this we need to know how the 2D projections relate to each other, ie., the angles and shifts between the projections (information from the tilt series setup in the microscope). The 2D Fourier transforms are aligned like the spokes of a wheel. In the central regions of this alignment, which corresponds to the low frequencies, there will be an over-representation of information. However, at the periphery, the high frequency region, these 'spokes' are spaced further apart and information will be missing. The more tilt angles, the less distance between these and the more complete the data. This difference in information means that it is necessary to weight the tilt images accordingly in the reconstruction. This reconstruction method is called the weighted back projection (WBP).





*Alignment of the 2D Fourier transforms of the projection images according to the central section theorem. This shows that more information is present in the lower frequencies in the central region while there is less at the periphery in the higher frequencies. This leads to the need to weight the information differently in the reconstruction. The limited number of available tilt angles leads the lack of information in the missing wedge.*

- Another method is simulative iterative reconstruction (SIRT). This produces rays projecting from an estimated tomogram and compares these to the data in the tilt images, looking for differences at each pixel. Using algebraic calculations, the tomogram is iteratively improved using these differences. The process is continued for a selected number of iterations. This gives a higher contrast tomogram and improves information lost in the “missing wedge” but is slower and loses higher-resolution information. Because of this, WBP is used for high resolution studies like sub-tomogram averaging. These processes are available in several available tomogram reconstruction software packages.



*Diagram showing how the back projections of the sample can be reconstructed into the original 3D volume of the tomogram.*

It's important to realise that the tomograms are distorted in the Z axis due the "missing wedge" of information. This results from the limited tilt range available when acquiring the data. Features parallel to the beam appear to be smeared. This can be overcome using averaging techniques and is particularly important in sub-tomogram averaging. At the outer edges of each projection there is also information missing between each projection. The more tilt angles collected the less information will be missing. The resolution of the tomogram is based on the Crowther Criterion

$$r = \pi D / N$$

Where the resolution is r, D is the object thickness and N is the number of projections (or tilt angles).

# Tomogram interpretation

---

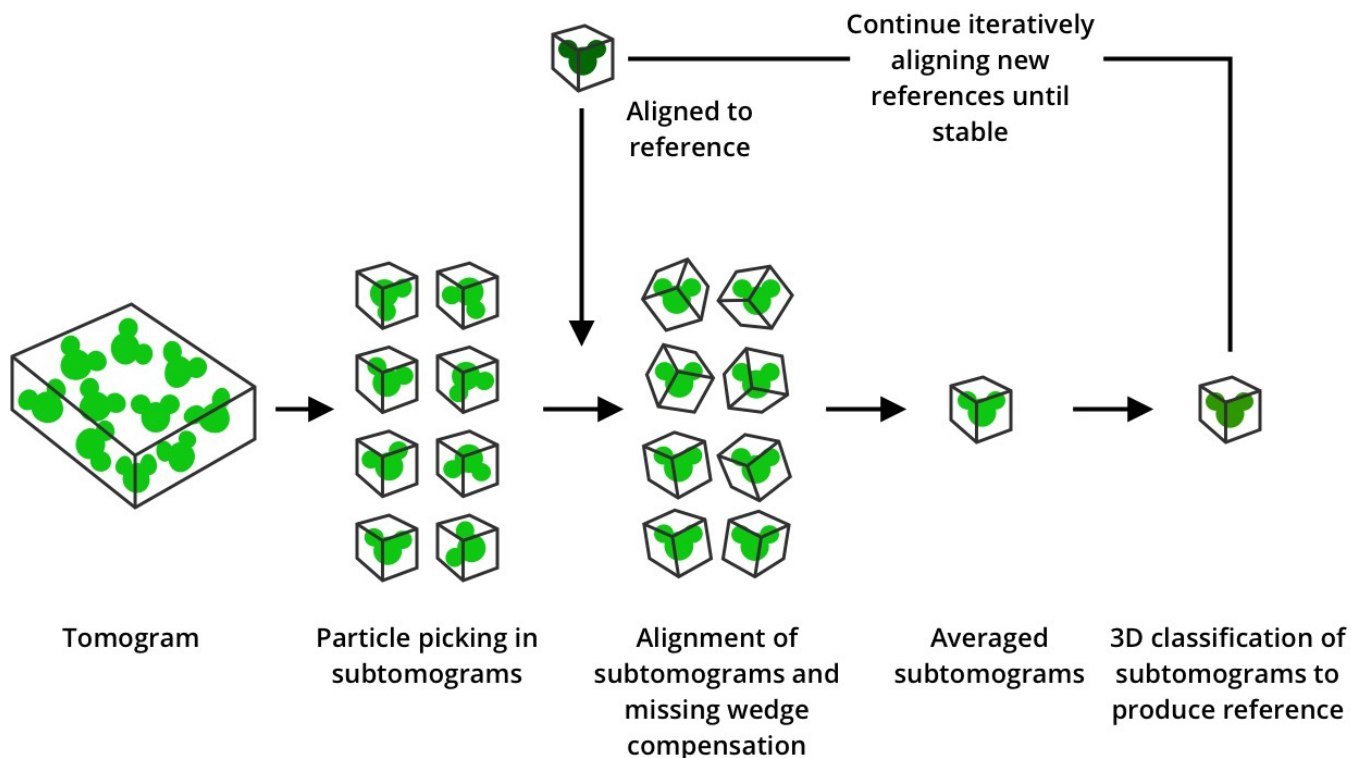
Tomograms are very complex and contain a lot of crowded structures. The SNR can be low and denoising filters may be necessary to enhance the signal, making structures more obvious. However, it can be difficult to discern individual objects in the reconstruction and visualise their structure and their relationship to other objects. Segmentation is a means of selecting structures of interest from the surrounding cellular milieu. Once removed, the segmented structures and the associations with other segmented objects can be readily seen in 3D. Segmentation involves drawing around the outline of the structures to delineate them from the rest of the tomogram and allow their extraction. It also enables full quantitative analysis of the data giving volumes, distances and other possible parameters.

Improved microscopes and detectors make it possible to acquire large numbers of tilt series per day. Such a large amount of data is difficult to annotate and quantify. Segmentation by hand is very labour intensive so many programs have been designed to aid in automating the process. Convolutional neural networks (CNN) are increasingly utilised to allow deep learning as a means of more automated segmentation.

# Sub-tomogram averaging – Introducing sub-tomogram averaging

Sub-tomogram averaging makes use of the tomogram produced by cryo-ET to determine the 3D structures of particles within that tomogram. If structures are present in multiple copies, such as proteins or multi-molecular complexes, they are extracted independently, then aligned and averaged to increase the SNR and improve the achievable resolution of the structure.

Sub-tomogram averaging is analogous to SPA but here the particles are available in 3D volumes as opposed to SPA where they are 2D projections. The advantage is that not only do you obtain the structure of the particle but you can also find the position and context of how it relates to its cellular environment.



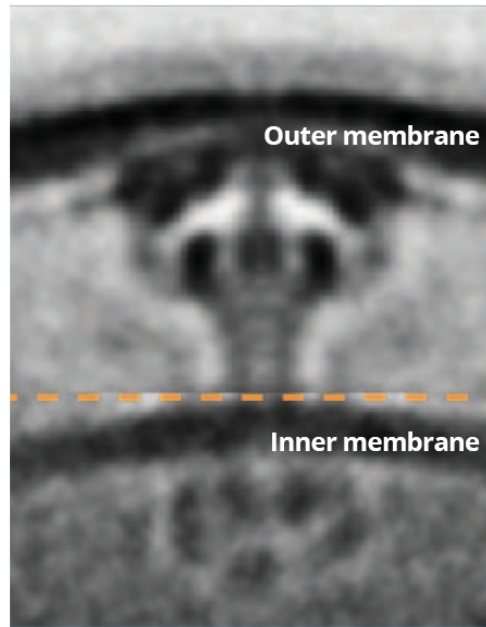
*Workflow for sub-tomogram averaging. Sub-tomograms containing the particle of interest are picked and extracted as sub-tomograms. These are then oriented to a reference averaged, and 3D classified to produce a new reference. This process is continued iteratively, producing a new reference each time, until there is no more refinement of the reference. After Briggs J.A.G. Curr. Opin. Struct Biol 2018 23, 261.*

It can be used for isolated purified particles and for structures within a cell. While in most cases particles can be resolved to 10–40Å, recent studies have shown <4Å resolution of particles in-situ in a cell and 2–4Å for isolated particles. Some studies have shown comparable resolution results using SPA and sub-tomogram averaging so in the future this technique could prove very useful to structural biology.

As well as the challenges faced in cryo-ET, additional challenges for sub-tomogram averaging are:

1. Sample flexibility and heterogeneity. Generally, the types of things examined by sub-tomogram averaging are more heterogenous and flexible than those using single particle analysis. SPA uses a purified particle preparation, which is usually quite homogeneous while in sub-tomogram averaging of particles in a cell, the particles are as they naturally appear in the cell.
2. Two alignment and reconstruction steps are needed. All the tilt images are aligned and averaged to produce a tomogram then sub-tomograms are extracted and another alignment and reconstruction is done on these.
3. Smaller datasets. The particles will not be present in the numbers available in the purified samples used for SPA studies, especially in cell preparations. The averaging is usually done on a smaller dataset of particles.

All these issues are being addressed by new developments in both hardware and software leading to gradual improvements in resolution of the reconstructed models.



*Averaged sub-tomograms of the Legionella pneumophila Type IV secretion system showing the context of the structure and how it sits within the inner and outer membranes of the cell. This is a composite of two different averages that have been joined along the dotted yellow line. Image courtesy of Debnath Ghosal, University of Melbourne.*

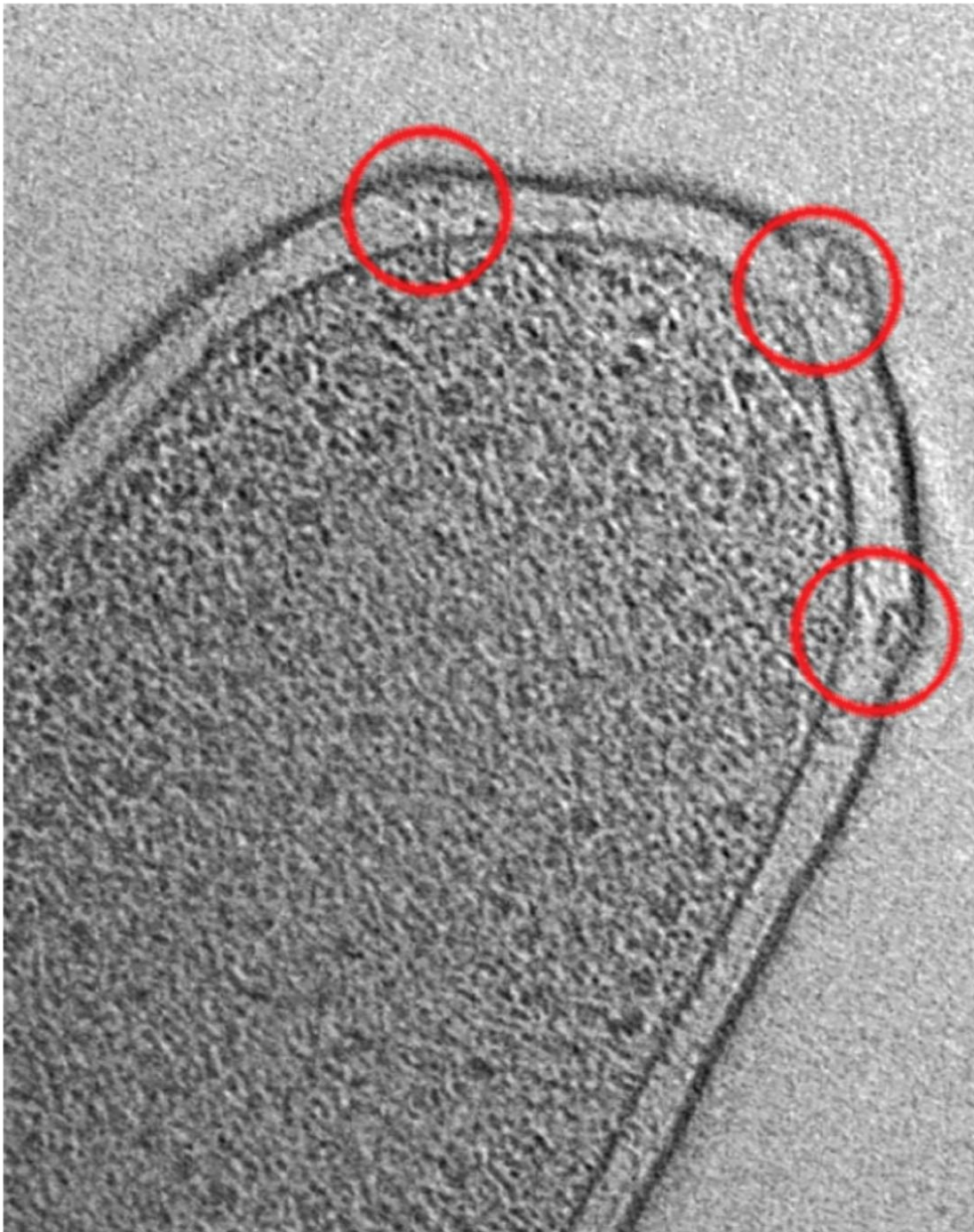
# Particle picking

---

The first stage is to locate the individual particles within the tomogram and define their coordinates. Several strategies for this have been used.

1. Particle picking relative to a support, for example they could be aligned along a membrane or a filament. With fixed spacing along the support, particles can be picked automatically. This can also provide information about the initial orientation angles of the particle.
2. Automated picking using a template. This can introduce bias if the template is not accurate, especially as these are often low resolution and taken from other data. With improved refinement of the map, particles can be repicked in an iterative process.
3. Picking using a trained CNN neural network.

Once picked, the sub-tomograms are extracted as a 3D boxed volume to be used in further analysis. While CTF correction was done when constructing the tomogram, a 3D CTF correction of the sub-tomograms is more accurate particularly when done per particle by accounting for the known height of each particle in each tomogram.



*Tomogram of a Legionella pneumophila cell. The Type IV secretion system structures have been picked from the reconstructed volume (red circles). Image courtesy of Debnath Ghosal, University of Melbourne.*

# Sub-tomogram averaging and alignment

---

Like SPA, in the sub-tomogram averaging workflow there is an alignment and averaging procedure performed iteratively. A set of sub-tomograms is aligned with a reference to give the best fit. The aligned sub-tomograms are then averaged to produce a new structure which is then the reference for the next round of alignment and this continues as an iterative process. The initial reference can be made from, or by generating a shape from, other information.

Alignments between the sub-tomograms and the reference are made by masking and rotating the reference to compare with each sub-tomogram giving a score determined by cross-correlation functions. As sub-tomogram averaging uses 3D data, three shift directions and three rotation axes must be used in this orientation alignment. Due to the limited range of tilt angles used in the original collection of data to produce the tomograms, each sub-tomogram has a 'missing wedge' of information. This can be compensated for by adding a wedge-shaped mask to the reference in Fourier space, so the sub-tomogram is always aligned with a reference that has a 'missing wedge' in the same orientation.

Often the data is binned to be more manageable and the first analysis is done at this low resolution. As the maximum resolution for each binning is reached, the amount of binning is reduced until the full data is included.

The full dataset is split into two independent datasets that are aligned and averaged separately. This minimises bias and overfitting of high frequency information. The iterative process of refinement is continued until some predetermined level of convergence is reached.

Maximum likelihood averaging may also be applied to also reduce overfitting by using weighting in the contributions of the different orientations.

## Sub-tomogram classification

---

Classification is performed during sub-tomogram averaging to: identify overlapping or misaligned sub-tomograms from oversampling that have been included in the dataset during the picking steps, and more importantly find and remove heterogeneous conformations. This produces a more homogeneous dataset.

Several strategies exist for classification through available software packages. The simplest form of classification is based on the cross-correlation values from the alignment step. By setting a threshold value for the cross correlation between the aligned sub-tomogram and the reference, all subtomograms below the threshold are removed from the dataset. Classification can also be done using principle component analysis (PCA). This statistical tool makes it possible to reduce the complex variables in the data to a smaller set of “summary indices” that can be more easily visualised and analysed while still preserving as much of the data’s variation as possible (**Principal component analysis**). This technique avoids the bias of using a reference template, although like cross correlation the technique is sensitive to the “missing wedge”. Maximum likelihood methods can also be used and these make use of continuously CTF corrected sub-tomograms.

To identify conformational differences in the subtomograms, covering specific regions within the structure with masks can produce region-specific classifications.

While the workflow described follows tomogram reconstruction, picking, averaging, alignment and classification as being performed one after the other, many software programs can process many of these steps simultaneously.

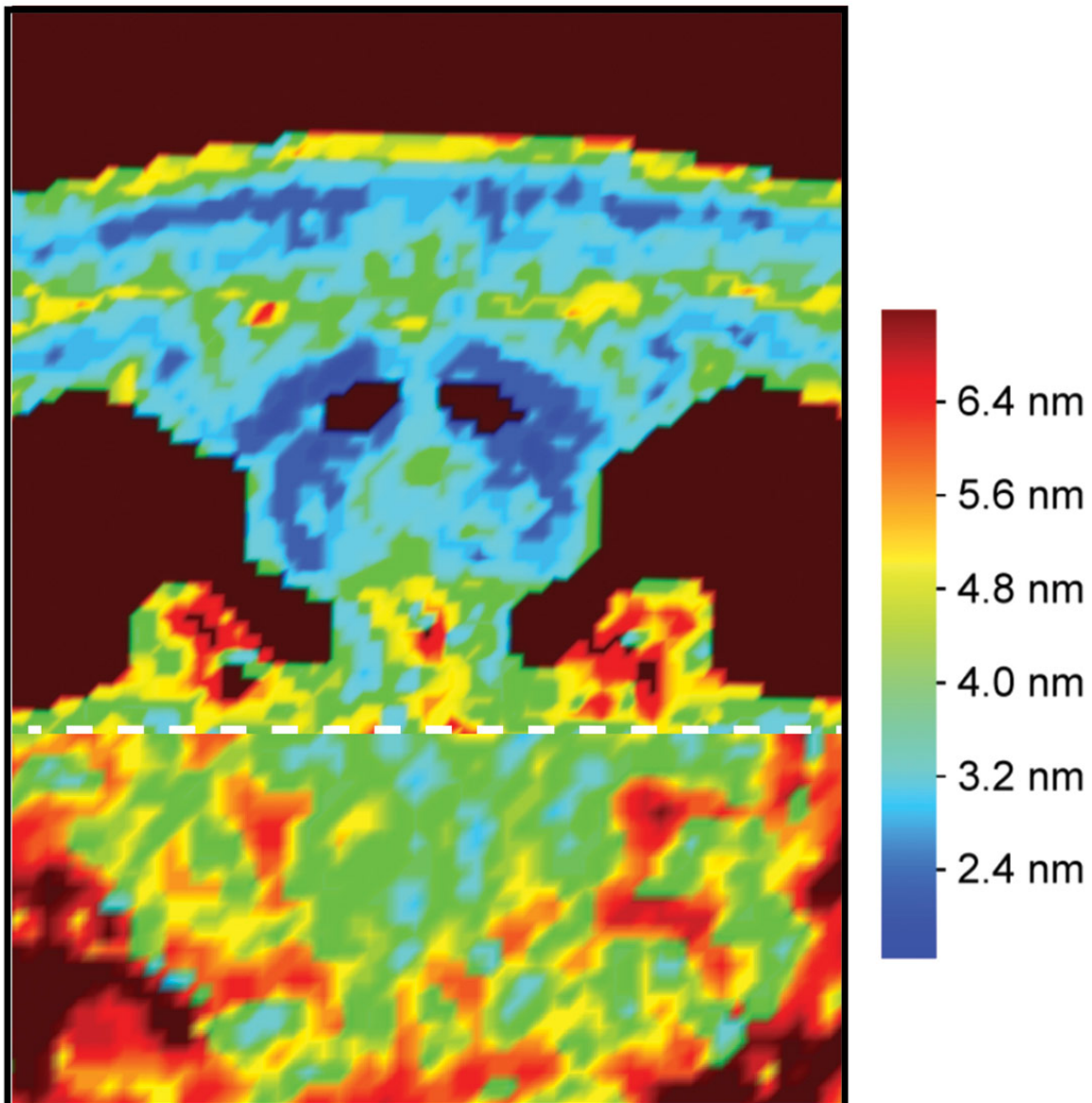


# Model refinement and validation

A lot of the procedures followed in SPA also apply to sub-tomogram averaging. Envelope functions dampen high frequency information in the same way and so a 'B-factor' must be used to sharpen the 3D reconstruction. Here B-factors are often higher than in SPA due to the fact that the particles can be quite heterogenous and that the high tilt angle means low resolution information is heavily over represented. Re-weighting strategies may also be necessary to overcome the under-representation of low frequencies and the uneven defocus.

Again, as performed in SPA refinement, the gold-standard refinement procedure is used. Data half sets are refined and aligned to one another to give a correlation measure, the Fourier Shell Correlation (FSC). A full description of the FSC is given in the single particle analysis section. This provides a structure resolution for each iteration and the new reference generated should be low-pass filtered according to this resolution. Low pass filters attenuate the high frequency (or more detailed) information.

Map validation is again important to show that the created model does truly represent the real structure. Validation methods similar to SPA are used, like checking if the secondary structure shows expected features and comparing against models made from other methods. A good means of validation is to check the structure in its 3D environment. For example, do they sit correctly along a membrane or are the reconstructed subunits of a helix actually distributed to form a helical pattern?



*Local resolution map of the reconstructed Type IV secretion system sitting within the cell envelope of Legionella pneumophila. Image courtesy of Debnath Ghosal, University of Melbourne.*



*Reconstruction of the Type IV secretion system of Legionella pneumophila made from sub-tomogram averaging of the structure in whole cells. Image courtesy of Debnath Ghosal, University of Melbourne.*

# Electron crystallography – Diffraction-based Cryo-EM Techniques

X-ray crystallography has been the most widely used diffraction technique for solving 3D structures. However, there are also two electron-diffraction techniques used in cryo-TEM for structural biology: 2D crystallography and microcrystal electron diffraction (Micro-ED). These both use the electron diffraction patterns generated when the electron beam is projected onto the crystalline sample. The crystal lattice acts as a diffraction grating, scattering the electrons to produce a diffraction pattern consisting of spots. From this pattern it is possible to deduce the structure of the crystal. Details on how electron diffraction works are available in the Transmission Electron Microscopy module but is also outlined in diagram below.

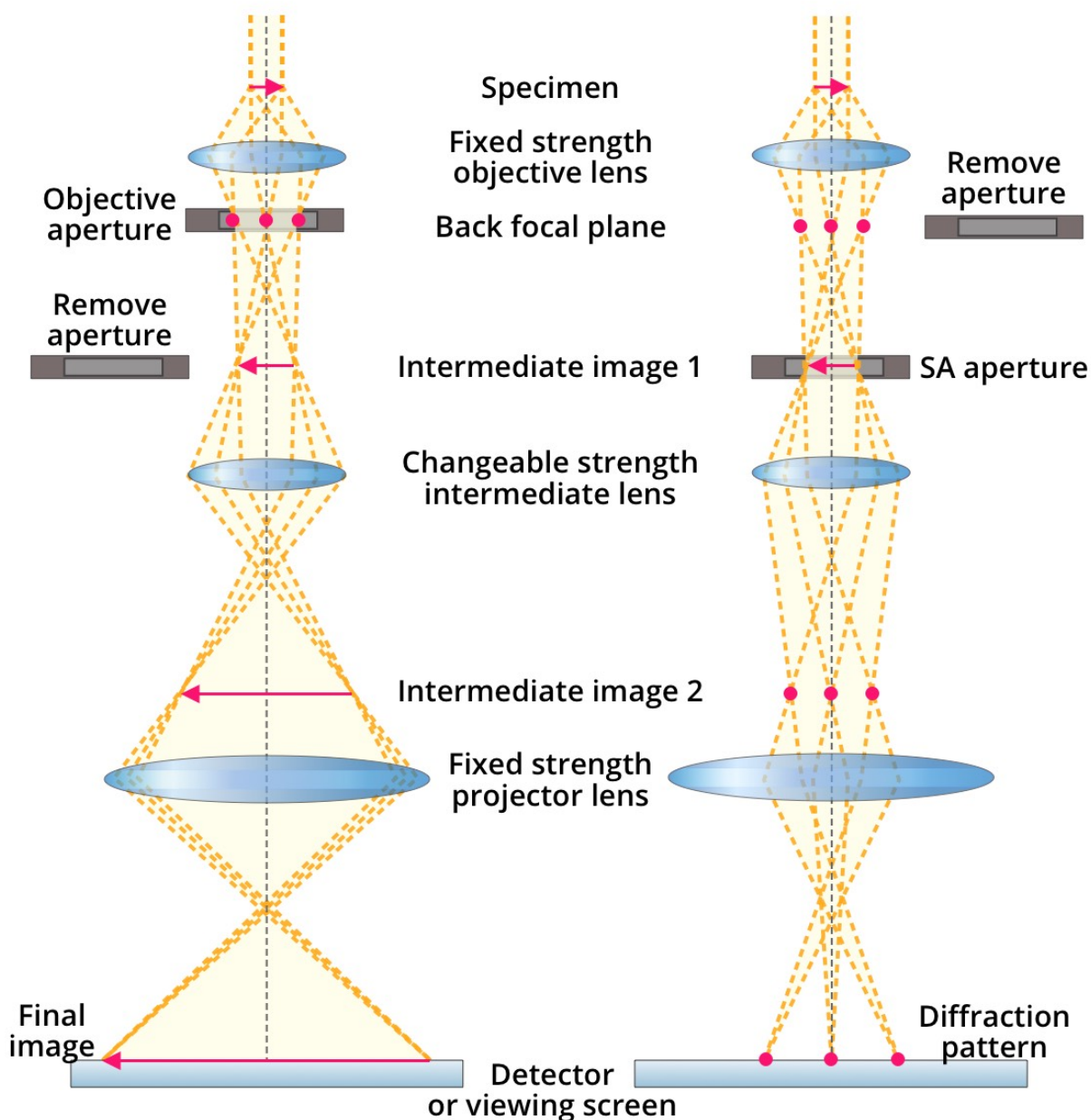
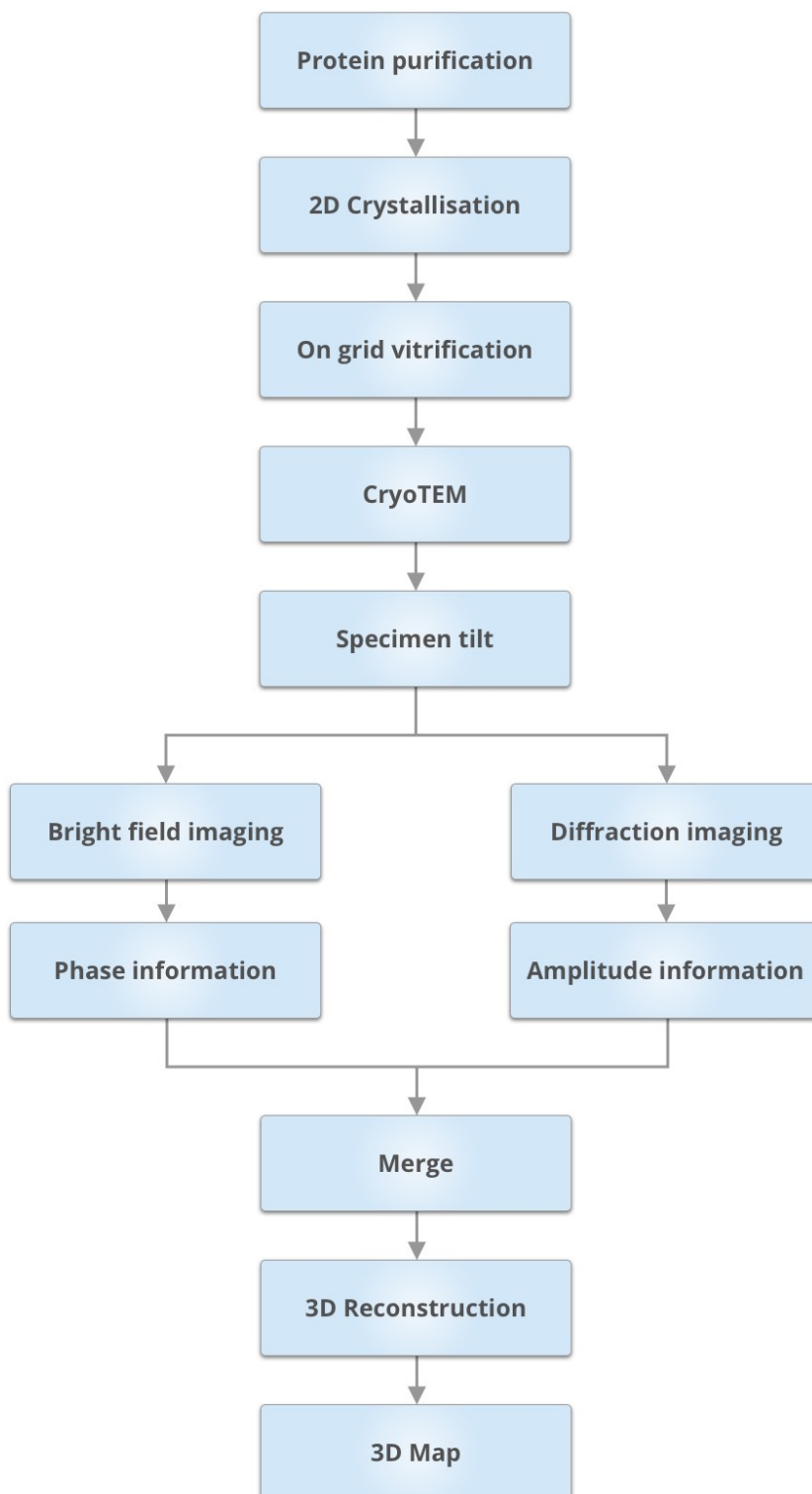


Diagram to show the different imaging modes of A. bright field and B. diffraction showing the beam path in the microscope and how the image is formed.

Unlike X-ray crystallography, each electron diffraction pattern displays information from a single plane in the crystal. To get all the crystallographic information it is necessary to collect diffraction patterns from a range of different crystal orientations. In Micro-ED this is done by tilting the crystal, and in 2D crystallography by collecting data from differently oriented crystals.

## 2D crystallography

2D crystallography was used to produce some of the first high-resolution cryo-EM structures and has been extremely valuable, particularly in the understanding of membrane protein structure. The technique relies on being able to produce 2D crystals, which are then vitrified. These are arrays that are only a single protein layer thick. To obtain high-resolution analysis it requires the collection of two datasets: a diffraction set, which provides the intensities and therefore the amplitude information, and an image set, which provides the phase information. The diffraction information is more accurate as it isn't affected by the CTF. Each 2D crystal is oriented differently on the grid so data collected from thousands of crystals is combined to a single dataset that is then used for structure determination. As it requires production of 2D crystals, and because both data collection and analysis are extremely time-consuming, techniques like Micro-ED and single particle analysis are now more commonly used in structural studies.

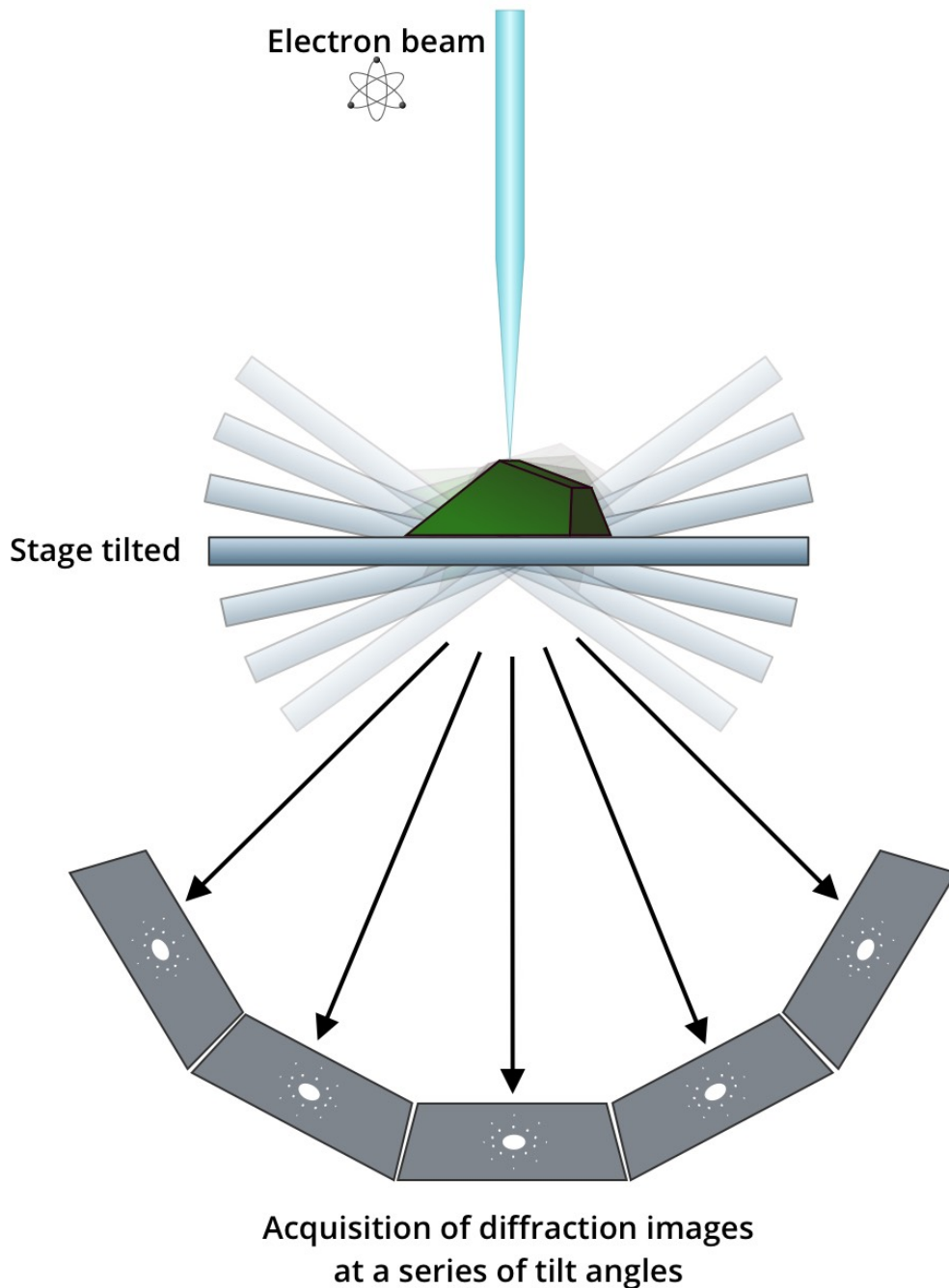


*Workflow for 2D crystallography showing the need for the two datasets.*

# Introducing Micro-ED

Micro-ED is able to solve structures much more quickly than other structural biology cryo-TEM techniques. It uses diffraction imaging rather than the brightfield imaging used in SPA and cryo-tomography.

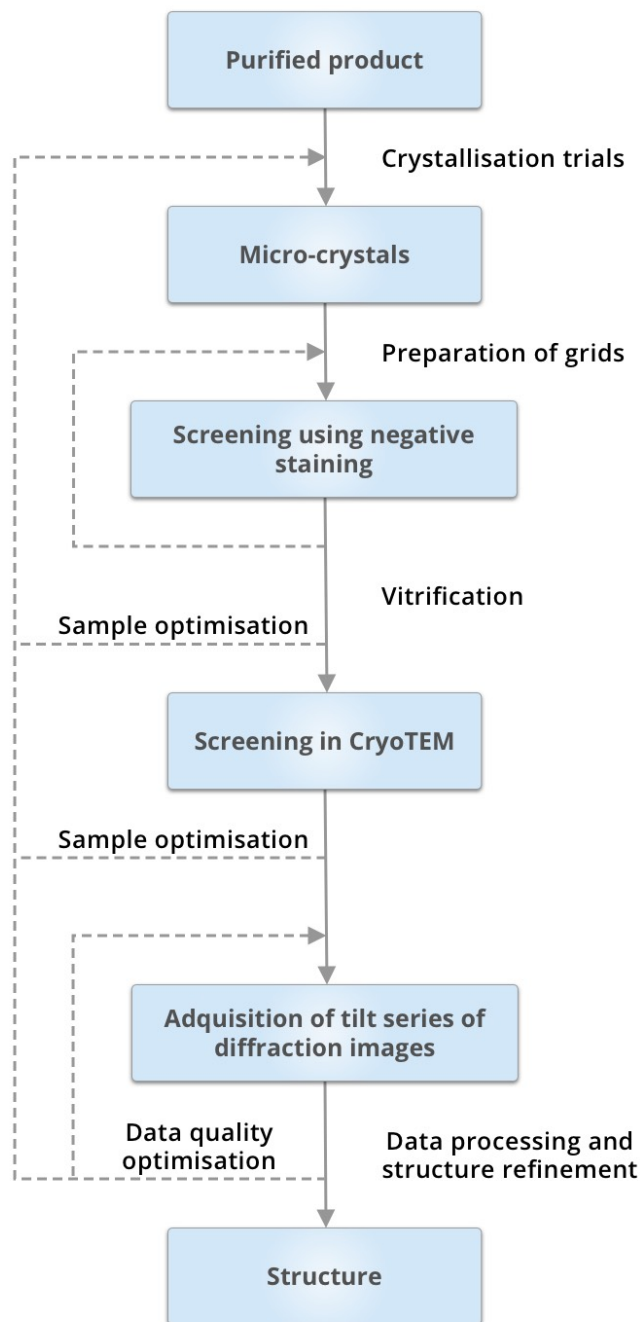
Micro-ED is based on the use of very small crystals, usually sub-micrometre to a couple of micrometres in size. Ideally the crystals would be <300nm thick as this is the mean free path of 300kV electrons. However, in reality, diffraction data has been successfully collected and processed from micrometre-sized crystals. By continuously rotating the sample, a series of diffraction patterns is obtained. Indexing, integration and merging of this diffraction data can then be performed in a similar manner as occurs in X-ray crystallography.



*Diagram showing the collection of a series of diffraction images as the micro-crystal is tilted through different angles, usually from +60° to -60°.*

This technique was first used in 2013, but recently it has received a lot of attention as it can be performed on cryo-TEMs already available in many labs and structures can be solved very easily at high resolution.

Unlike X-ray diffraction, electron diffraction doesn't give 3D information from a single diffraction pattern. However, relative to X-rays, each electron scattering event is less damaging to the crystal. As a result, electron diffraction data can be collected at ultra-low dose and many exposures can be captured by tilting a single crystal. The multiple diffraction patterns collected through the tilt series provide the full 3D data.



#### Workflow for Micro-ED

The small crystals used in Micro-ED can help get around the problem of growing the large, high-quality crystals needed for X-ray diffraction. Growing large crystals can be a difficult and sometimes impossible step, especially in the case of membrane proteins and protein complexes.

The range of sample types that are amenable to analysis through Micro-ED is increasing all the time. Not only basic proteins but membrane proteins, peptides and even very small molecules have been reconstructed to high resolutions, in some cases to  $< 1\text{\AA}$ .

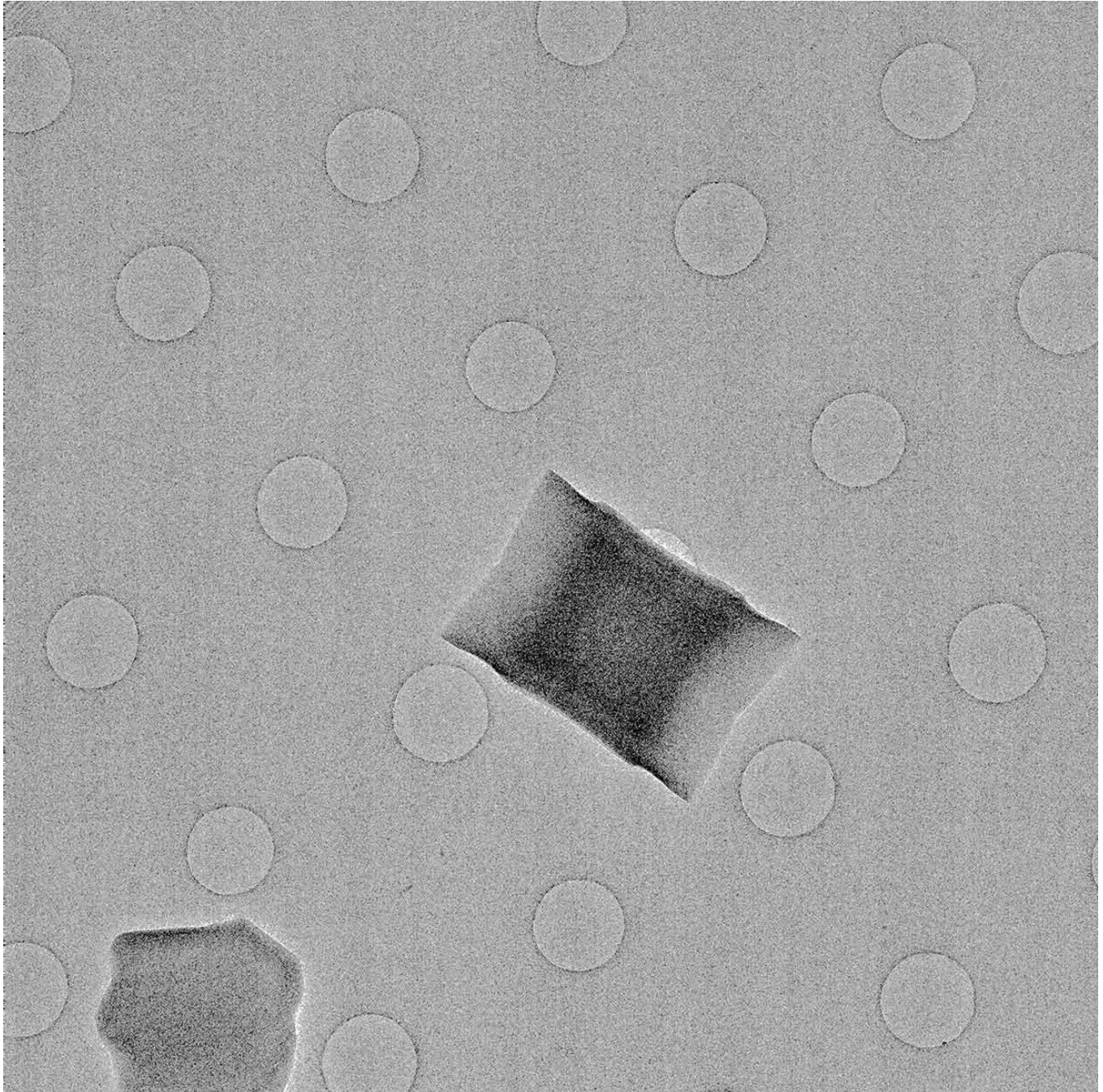
For pharmaceuticals, often the powder itself contains small crystals or simple crushing can produce fine crystals. So, sample preparation is incredibly fast, only very small amounts of material are needed and a result can be achieved in a very short time, sometimes as short as 30 minutes from powder to structure.

The technique can also be used in the material sciences for looking at structures like nanoparticles, metal-organic frameworks and zeolites, achieving high resolutions on difficult samples with very small amounts of material. If the samples are not beam sensitive this can even be done at room temperature.

## The sample for Micro-ED

---

This technique really needs nanocrystals, usually 1–2 $\mu\text{m}$  in diameter, but less than 400nm thick. These can be grown by similar crystallisation techniques to those for X-ray crystallography and even if the conditions will not produce samples suitable for X-ray crystallography, they can actually contain useful nanocrystals for Micro-ED. The first issue is finding these as they aren't easily resolved in a light microscope. However, screening of samples using negative staining EM is useful though the stain can cause deterioration of the crystals. It is also possible to produce nanocrystals by breaking down larger crystals, by sonication, vortexing, or even crushing.



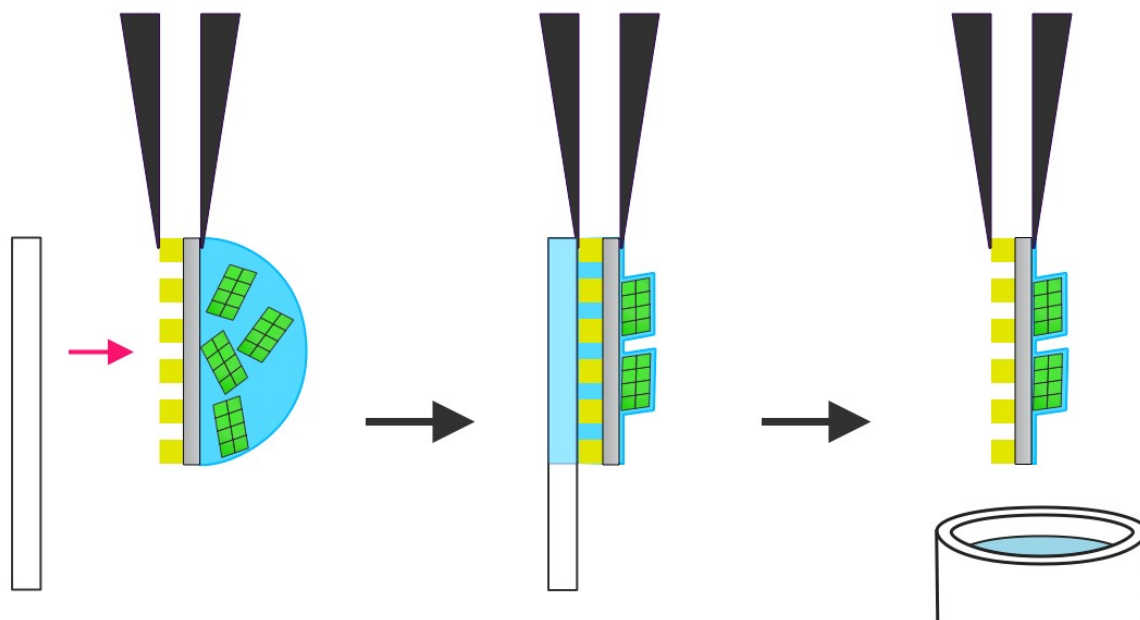
*Vitrified small crystal of a fluorobenzene complex sitting on the carbon film of a grid.*

The cryo-FIB has been used to thin larger crystals to make lamellae. These samples produce exceptional quality diffraction patterns and structures of  $< 1\text{\AA}$  have been obtained using them. The milling also removes the thick ice that can sit around the crystals and dampen high-resolution spots in the patterns.

Lipidic cubic phase or lipid bicelles have been used for proteins that need a lipid environment in which to crystallise. Proteins can diffuse and form small crystals within the continuous lipid bilayer. Membrane proteins are well suited to such techniques. These can be very viscous and specific dilution techniques or cryo-FIB have been used to make samples suitable for Micro-ED.

## Sample preparation for Micro-ED

The samples are beam sensitive and so it is important that they are vitrified, so that individual crystals are embedded in amorphous ice. This is performed in a similar manner to preparation of samples for SPA where a small drop of crystal-containing solution is applied to the grid, blotted and plunge frozen in liquid ethane.



**Solution of micro-crystals added to holey carbon grid**

**Grid is blotted**

**Plunge frozen in ethane**

*Workflow for preparing samples for MicroED. After Martynowicz, M.W. et al. 2020, 117, 32380.*

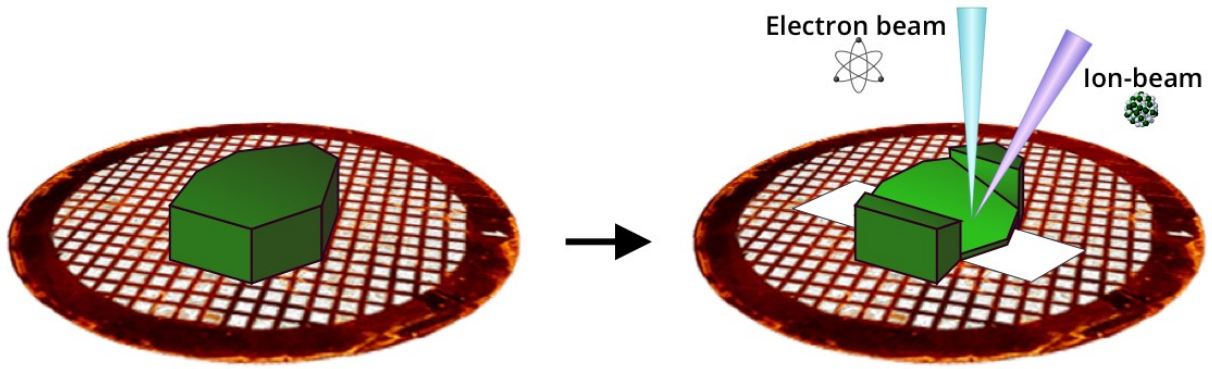
Most crystals are hardy to freezing but cryoprotection can be valuable for sensitive crystals.

Grid preparation and optimisation can be the most time-consuming stage of the workflow. The vitrified grid needs to contain a good number of diffraction quality crystals in thin ice. The ice needs to be thin enough for the penetration of the electron beam but thick enough to support the sample fully.

The samples are prepared on holey carbon grids like those used in SPA but here the data is collected from crystals sitting on the carbon film, rather than in the holes.

Recently, the cryo-FIB has shown great promise in producing samples for Micro-ED. It has been used to prepare samples of the desired thickness from thicker crystals by using the ion beam to mill away the excess material.

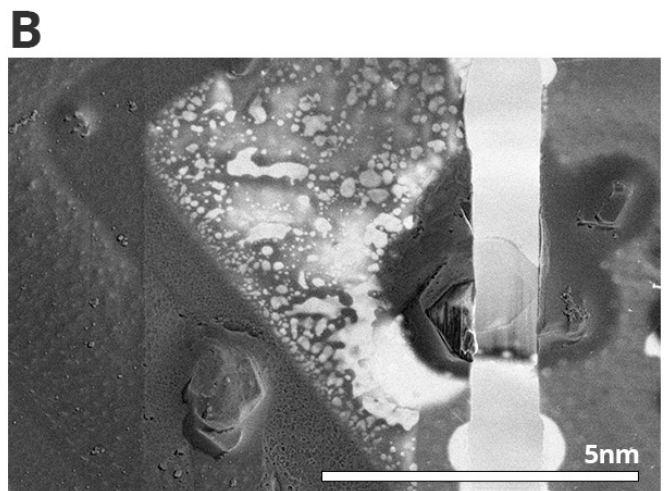
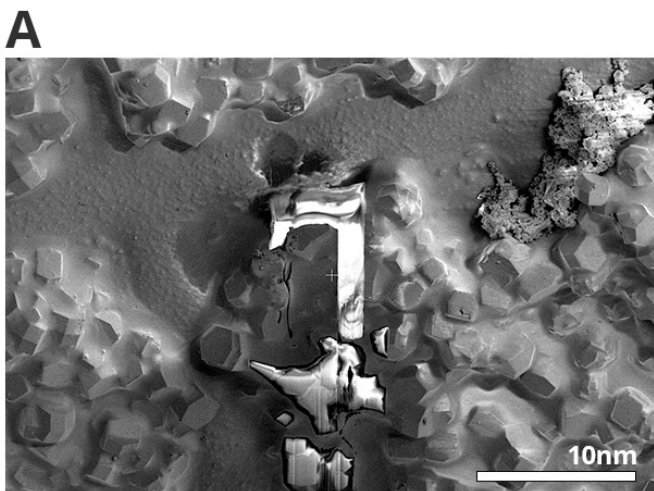




Large crystal vitrified on grid

In the cryo-FIB the crystal is thinned to a lamella using the ion beam

*Production of lamella in a larger crystal using the cryo-FIB.*



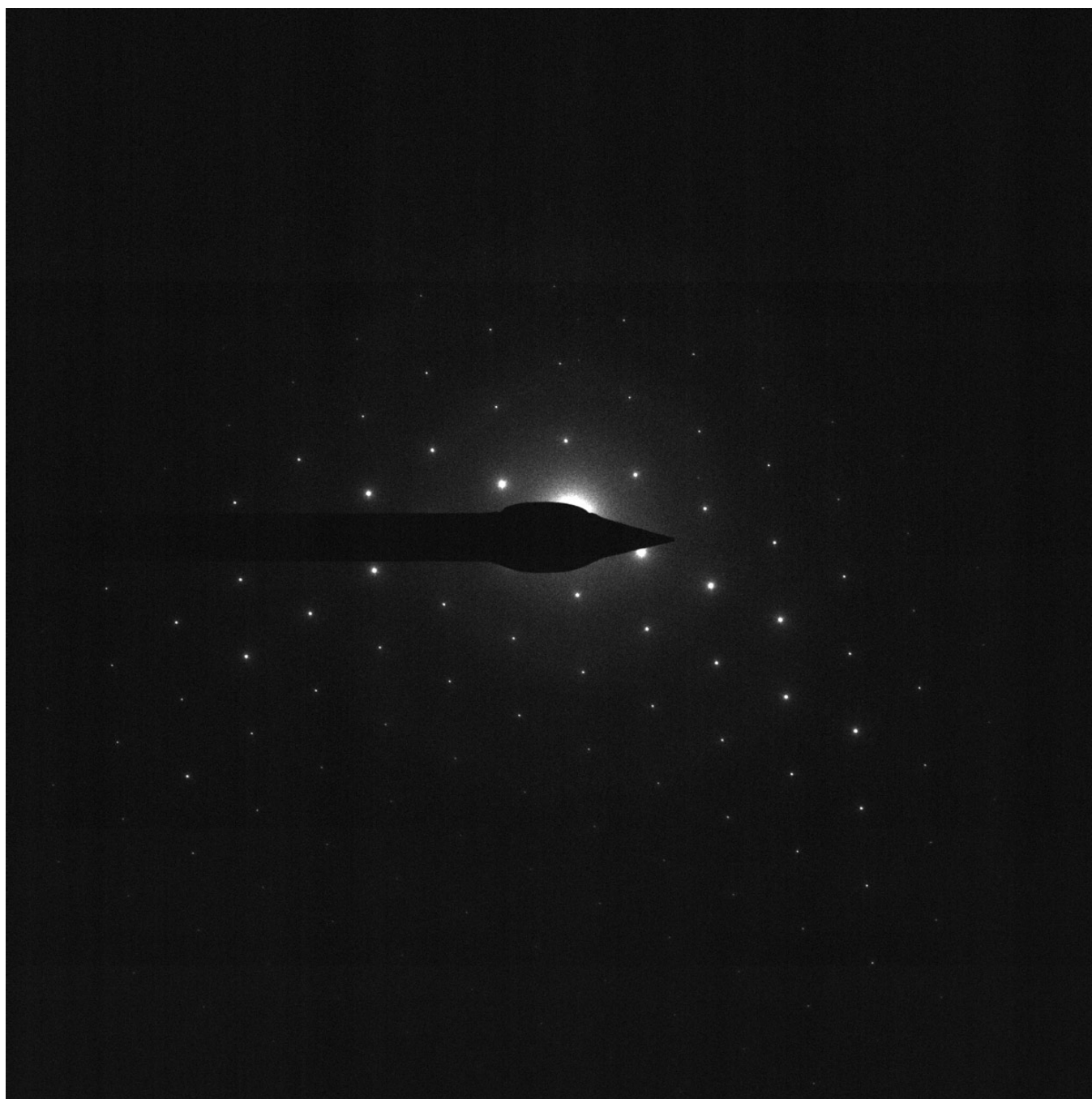
*Electron beam images taken inside the cryo-FIB showing A. a low magnification image of several crystals 10-20 $\mu$ m in diameter with a lamella thinned in one of them. B. a higher magnification image of the lamella. Images courtesy of Gediminas Gervinskas, Monash University.*

# The TEM for Micro-ED

---

A standard cryo-TEM can be used if it is equipped with the following:

- a stable cryo-stage
- a field emission gun, which is important for a coherent beam and most studies have been done on a 200kV instrument though lower voltage microscopes are still suitable.
- a stage capable of fine rotation to high angles.
- an in-column electron energy loss filter to reduce noise is important to both screening and data capture. In systems where the energy filter is post column other pre-filters are used.
- a detector with a high dynamic range and a fast readout. A high-quality CMOS camera is suitable for this work, a much cheaper option than the direct-electron detectors used in SPA. However, the direct electron detectors can also be used.



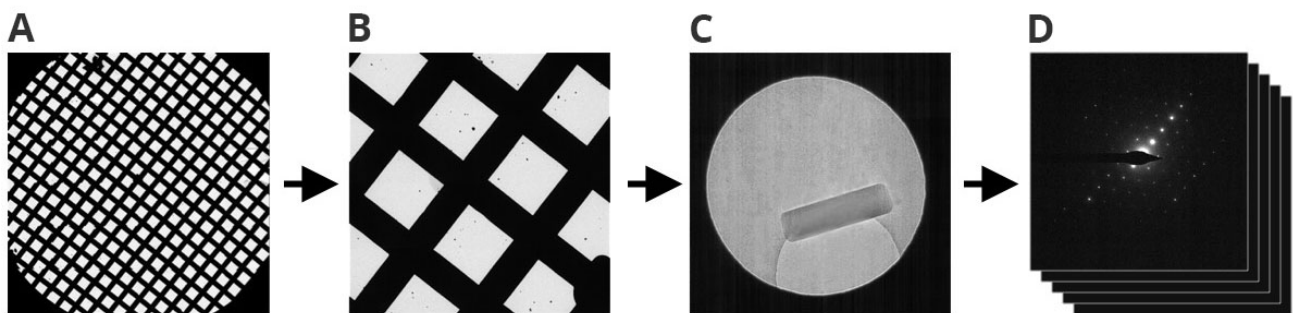
*Diffraction pattern taken from a crystal of the small molecule drug, curcumin. Image courtesy of Nick Ariotti, University of New South Wales.*

# Sample screening for Micro-ED

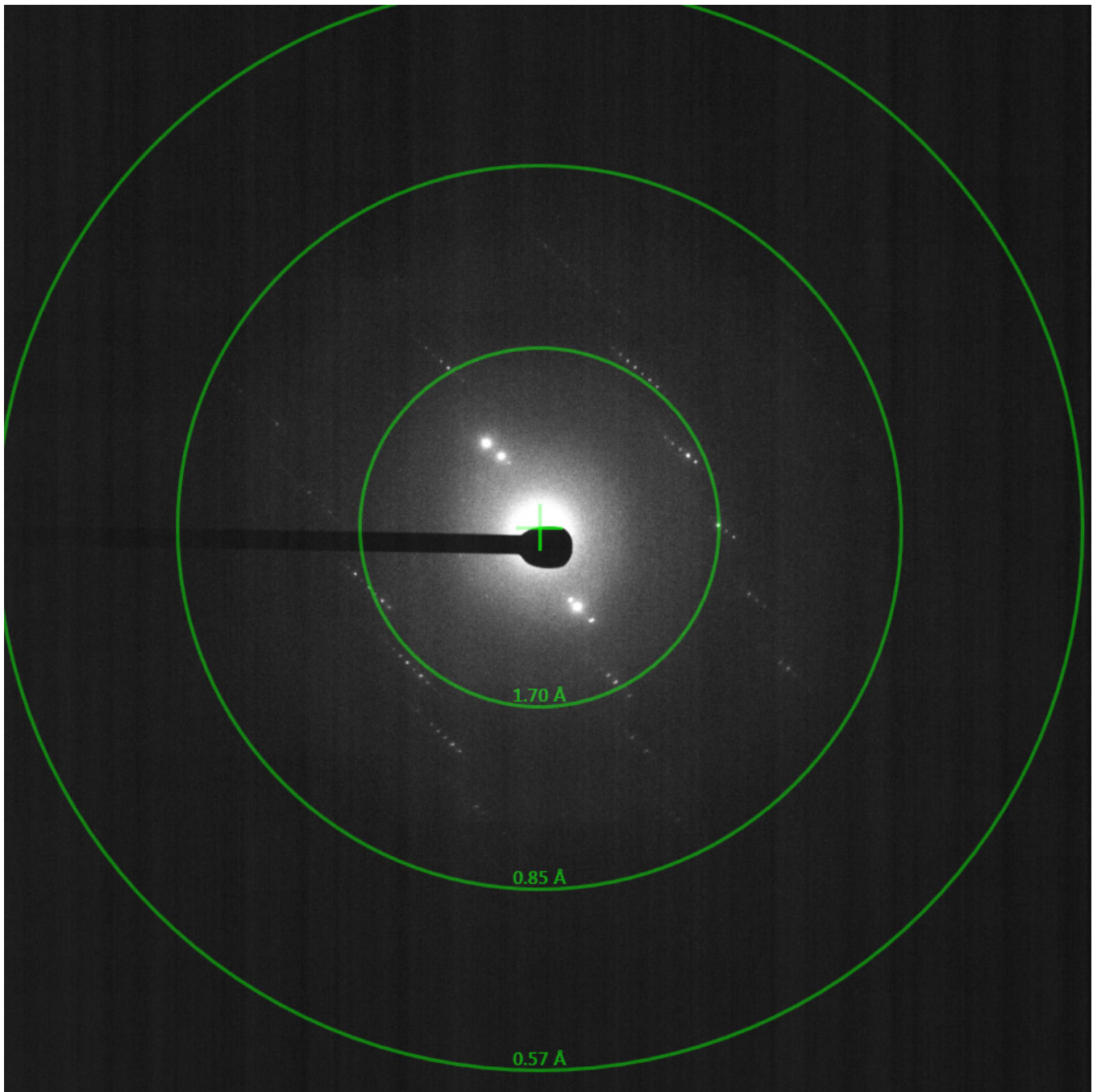
Screening is performed in the TEM under low dose conditions.

- At low magnification the vitrified sample is screened in the microscope to find areas of good ice thickness as judged by the beam intensity. It is then inspected for good crystals that show a defined edge and are isolated from other crystals and the grid bars.
- If the ice is too thick or there aren't any good crystals, change to another grid or prepare a new sample.
- Move a crystal to the centre of the screen.
- The eucentric height needs to be accurately set up to ensure the sample does not move during the rotation.
- Change the microscope to low dose diffraction mode.
- Collect a single test diffraction pattern from a single crystal and then blank the beam.
- The diffraction pattern is inspected for spots that are sharp, well separated and extend far from the centre, indicating the presence of high resolution information.
- If the diffraction pattern is good then prepare to collect a dataset. If not then move to another crystal and collect another diffraction pattern.

New software packages allow automated screening and collection of the data.



*Workflow for Micro-ED. A. An atlas image of the entire grid is collected by stitching together sequential images. B. Potential grid squares are then checked for possible crystals. C. Individual crystals are then picked out. D. A series of diffraction patterns are collected as a movie.*



*Diffraction pattern taken from a crystal of the ..... Image courtesy of Nick Ariotti, University of New South Wales*

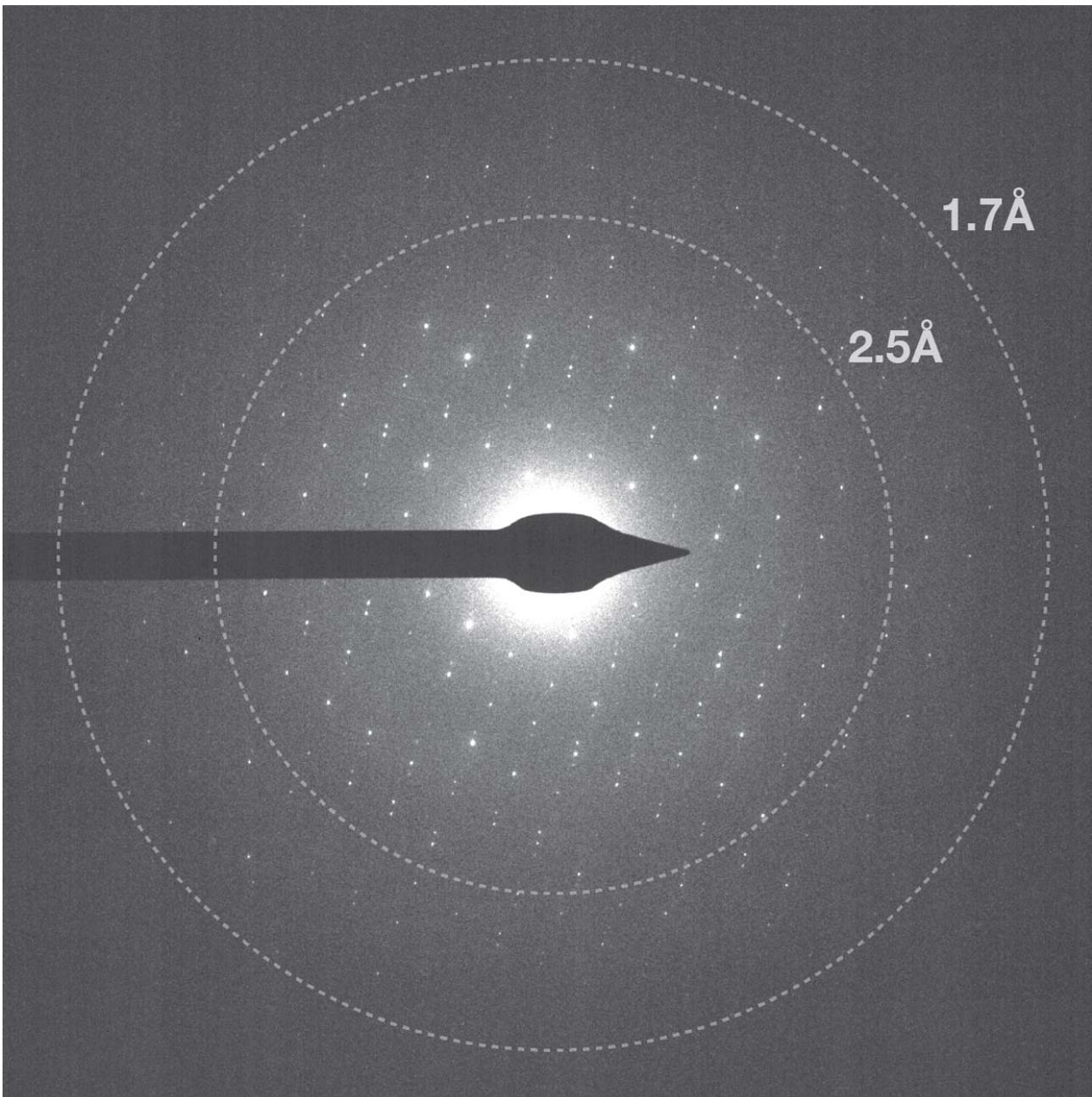
## Data collection – Micro-ED

The microscope is set to automatically collect a dataset from the crystal identified as high quality.

- It is set to ultra-low dose, usually  $0.01\text{--}0.05\text{ e}/\text{\AA}^2/\text{s}$
- The stage is set to tilt continuously through from  $+70$  to  $-70$  degrees with a speed of rotation set to match the capture of frames of the detector.
- The detector is set to capture in rolling shutter mode so it is continuously active.

The dataset is captured as a movie consisting of frames each with single diffraction pattern and collected over the full range of tilt angles. Each movie takes only a few minutes to collect. Datasets from several different crystals are captured and merged as the information in one dataset may not cover all 3D reflections due to the limited tilting range. As the crystals are distributed in different angles the merged data will increase completeness.

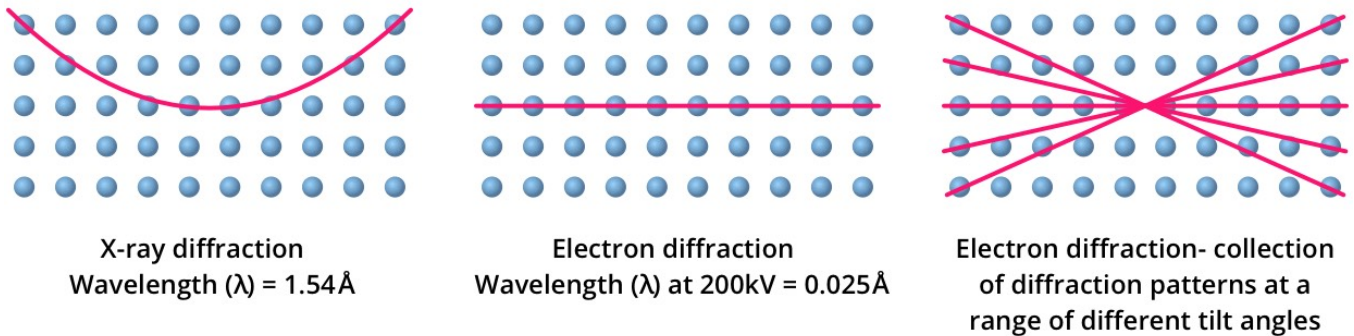
However, in cases where the crystal orientation and symmetry are favourable, data collection from a single crystal can be enough to determine a high-resolution structure. It is possible that if crystals diffract well, the entire process of data collection and structure solution can be performed in under an hour.



*Diffraction pattern taken from a crystal of the lysozyme. The sample was prepared using a cryo-FIB to make a thin lamella in a larger crystal. Image courtesy of Chris Lupton, Monash University.*

# Data analysis – Micro-ED

When the wavelength of the radiation to be scattered is much smaller than the spacing between atoms, the Ewald sphere radius becomes large. The Ewald sphere, represented by the pink line in the diagram below, shows which reciprocal spots are going to be present in your diffraction pattern. For X-ray crystallography the diffraction pattern gives 3D information from a single diffraction pattern. However, in electron diffraction, because the wavelength is so short, the Ewald sphere is extremely large and so is essentially flat over the region of interest. This means that the orientation is missing so you can't index a crystal from a single pattern. Therefore, Micro-ED requires multiple diffraction patterns collected at known orientations to one another and this allows full indexing of the crystal. As mentioned earlier there is still some missing data due to the limited range of tilt angles so it is usually necessary to merge several datasets.



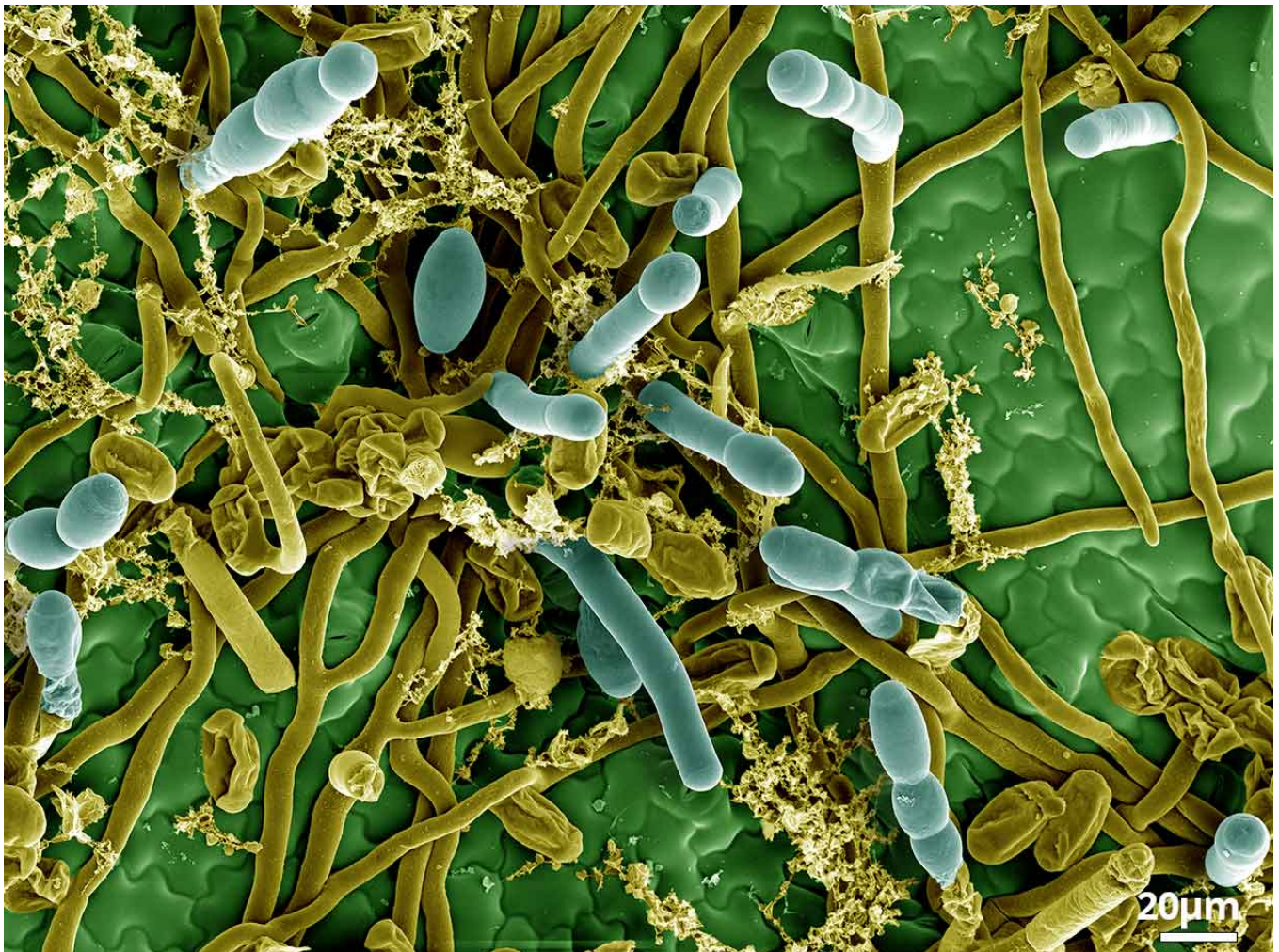
*Ewald sphere for both X-ray diffraction and electron diffraction. Using electrons, the short wavelength means that the sphere becomes so large that in any plane in it appears flat. As a result, a single diffraction pattern of the still crystal contains limited information, appearing as a 2D slice. Therefore diffraction patterns are collected at a range of angles by tilting the crystal to ensure completeness of the information in the dataset. After Nannenga, B.L. and Gonen, T. Curr. Opin. Struct. Biol. 27, 24.*

Once the datasets are collected they will need to be converted into a file format that is recognised by X-ray crystallography programs. Then the data is fully processed, including integration, scaling and merging, using software developed for X-ray crystallography, which makes it relatively straightforward for users with this experience. Phasing and refinement of the model can also be completed in standard X-ray crystallography software using molecular replacement. The only difference in handling Micro-ED data is that you must adjust the settings to account for electron scattering factors.

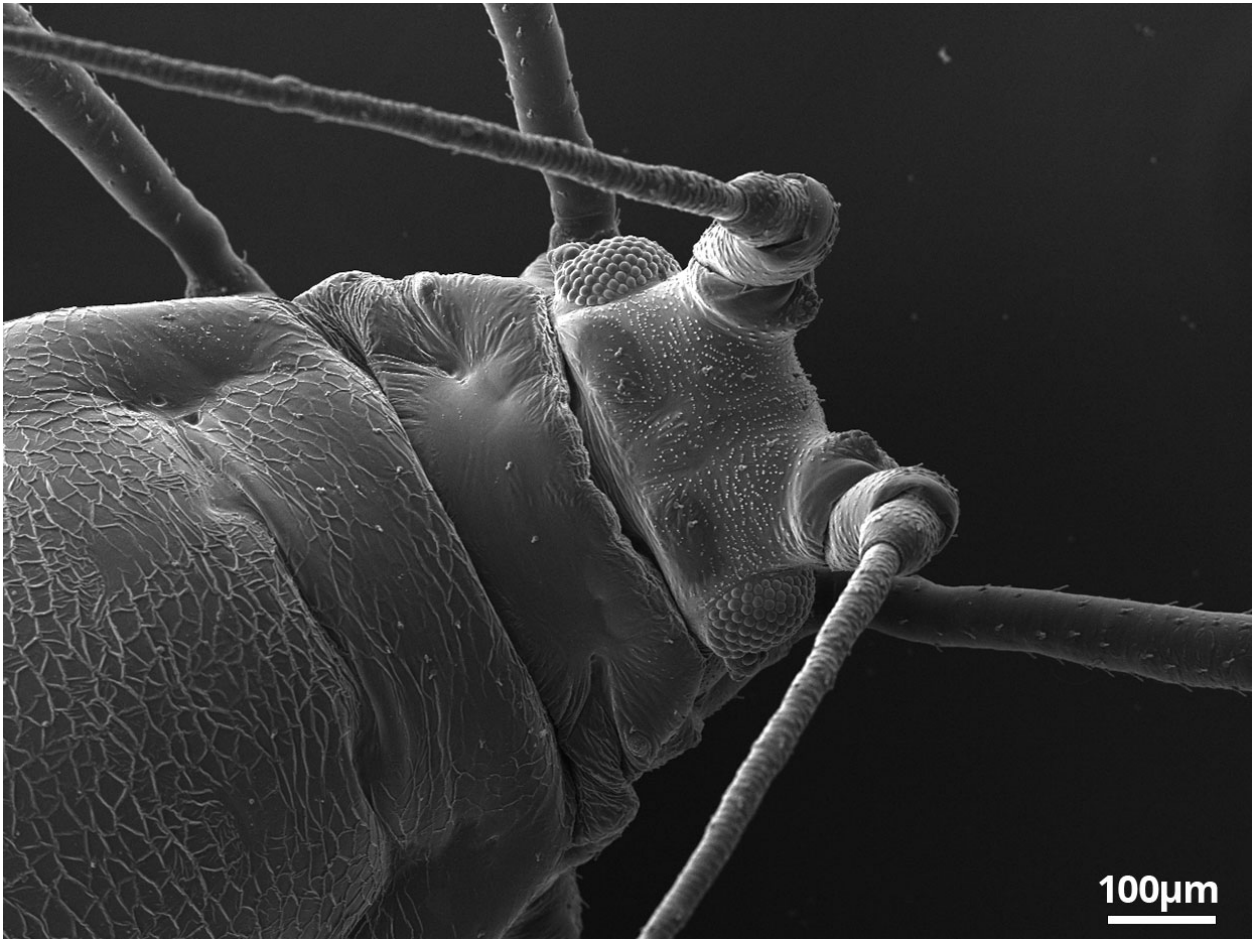
# Cryo-SEM – Introducing cryo-SEM

The cryo-SEM allows the study of samples in their fully hydrated state in a quick and reliable way. This avoids the difficulties involved in preserving wet samples for SEM observation via conventional means with chemical fixation. Samples are cryofixed and then transferred to a cryostage inside the SEM. The technique has been particularly useful for observing all wet samples, especially food and pharmaceutical products as well as biological samples. This process has many advantages,

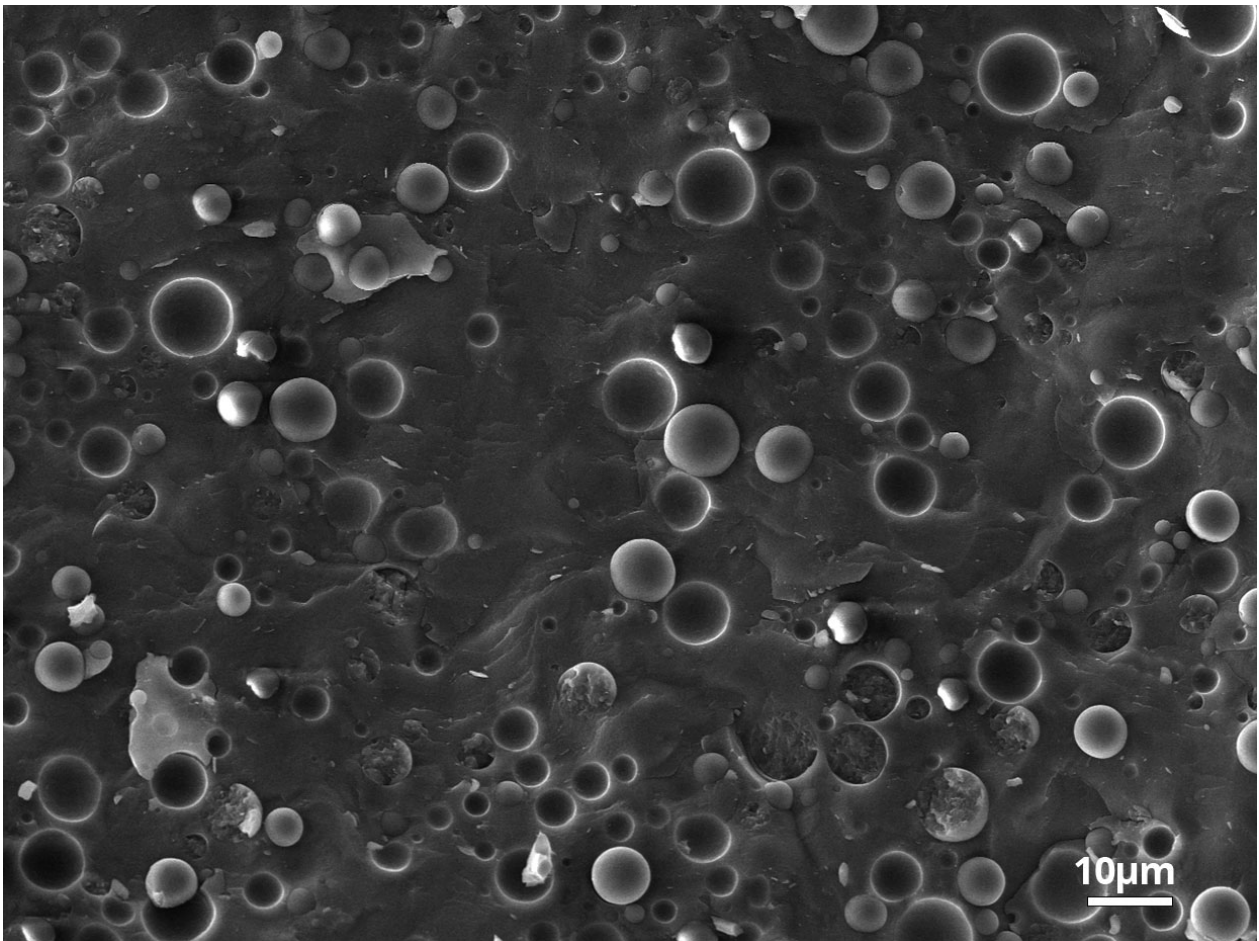
- The specimen can be viewed in its fully hydrated state.
- Avoids artefacts introduced by conventional processing, through both chemical fixation and dehydration. Even using specific drying techniques, it is impossible to avoid some changes – especially shrinkage – of any wet sample.
- Sample preparation is generally quick and relatively simple. Conventional processing protocols for room temperature SEM involve many steps and can be time consuming. For cryo-SEM it is possible to view samples in less than one hour.
- Creates less mechanical damage (fragile samples can easily be damaged during conventional processing). Many delicate samples suffer from collapse or breakage during standard processing and drying.
- Almost no relocation or loss of soluble or diffusible components. This makes cryo-samples ideal for microanalytical studies.
- Avoids use of, and exposure to, the toxic chemicals involved in conventional processing.
- Allows viewing of liquid samples like emulsions or gels.
- With cryofixation the preservation is quick, allowing dynamic processes to be instantly stopped and viewed. Time course experiments can be followed by freezing samples at timed intervals.
- Allows the observation of samples that are beam or vacuum sensitive. At low temperatures, samples are stable even at high vacuum.
- By fracturing or cutting open a frozen sample you can create a cross-section and study the inside of the sample.



Colour-enhanced cryo-SEM image of mildew on a zucchini. Image courtesy of Peta Clode and Jeremy Shaw, University of Western Australia.

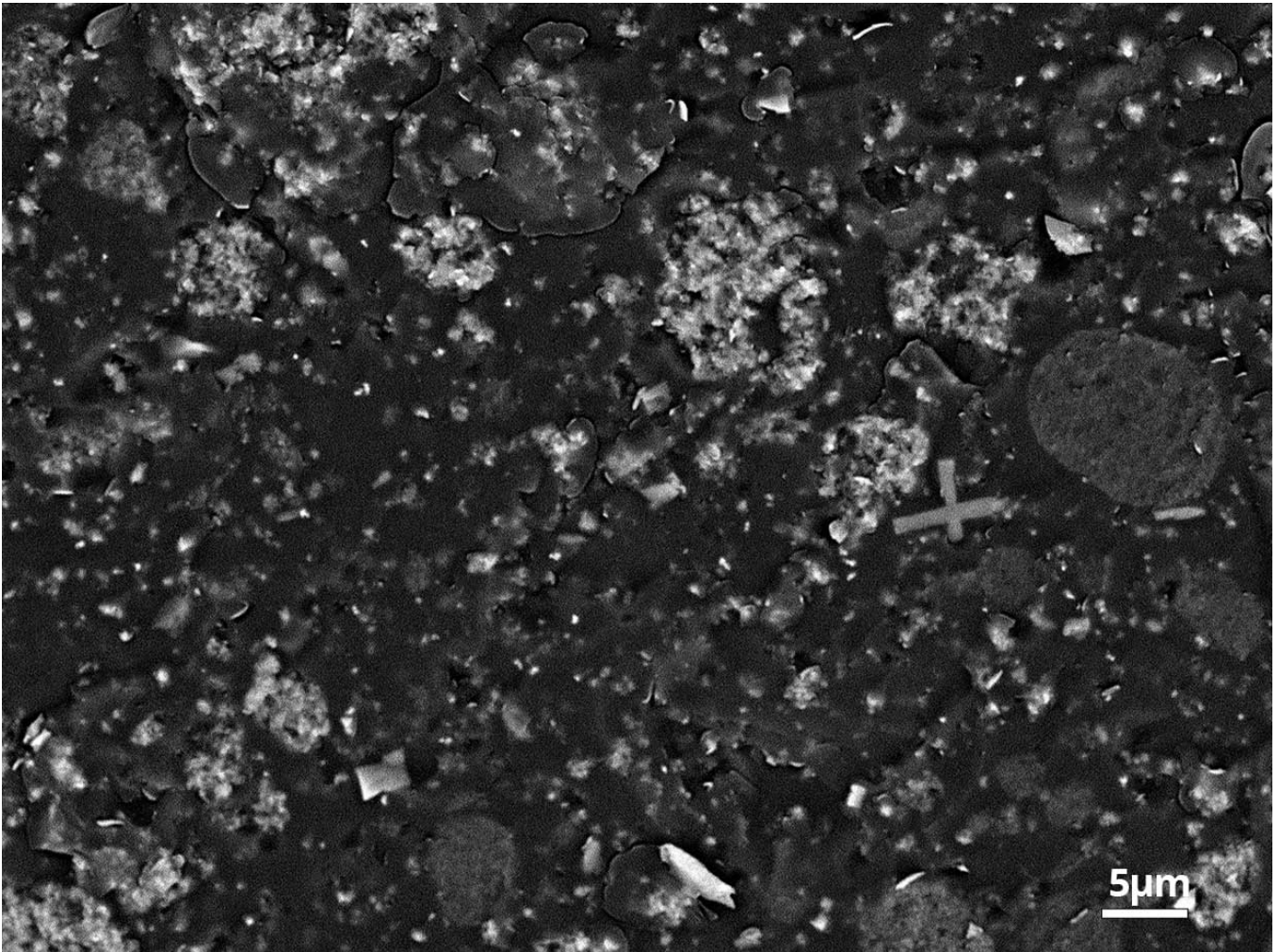


*Cryo-SEM image of an aphid. Image courtesy of Peta Clode, University of Western Australia.*



*Cryo-SEM image of mayonnaise. Image courtesy of Peta Clode, University of Western Australia.*





*Cryo-SEM image of toothpaste imaged using a back-scatter detector. Image courtesy of Lyn Kirilak, University of Western Australia.*

The technique has found wide application for studies on many samples, any wet sample is ideally suited to the technique.

# Cryo-SEM design

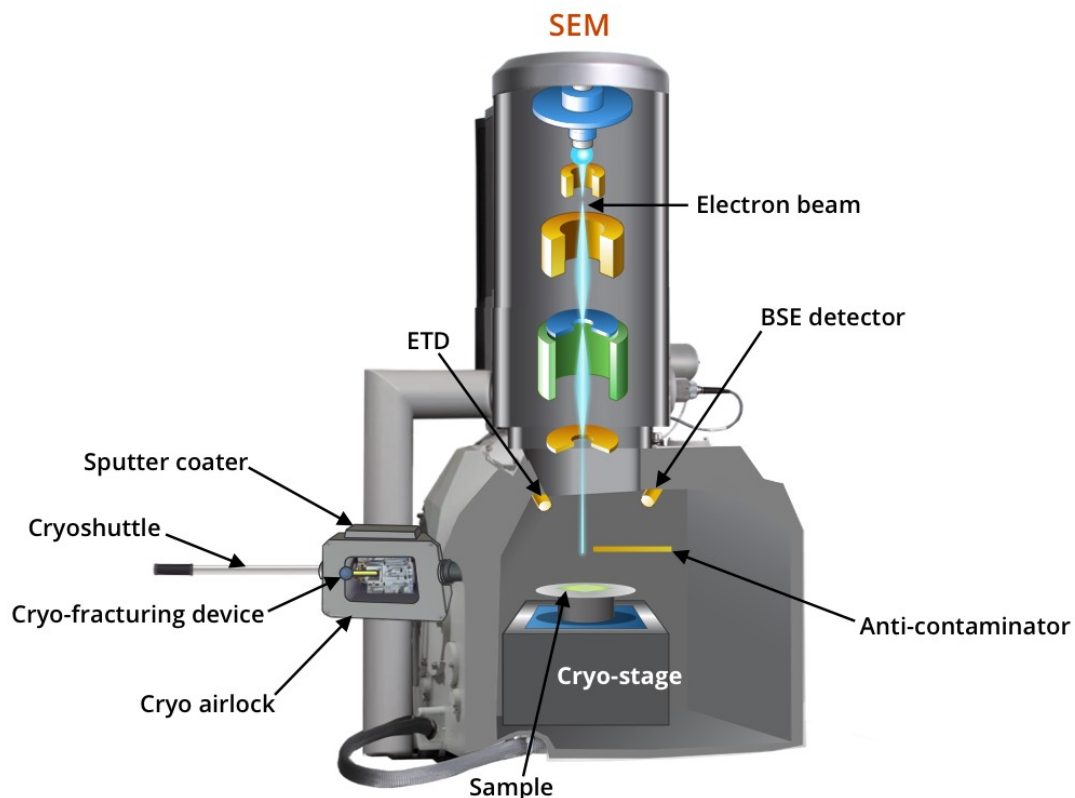
After freezing, the sample needs to stay cold for all subsequent preparation steps and for SEM imaging. A standard SEM can be used but extra components are necessary to prevent the sample from thawing out: a cryo-shuttle and a cryo-preparation chamber plus modifications to cryo-SEM itself: an airlock, a cryo-stage, and an anti-contaminator.

The shuttle is a means of transferring the sample between the separate components of the cryo-SEM workflow. This cryo-transfer device allows the sample to be kept cold and under vacuum during movement from external sample preparation chambers to the microscope.

The cryo-preparation chamber is where the sample can be fractured, etched, and coated whilst being kept under vacuum and at low temperature. It can either be a permanent device attached directly to the microscope or can be a completely separate benchtop unit.

The stage in the cryo-SEM must be temperature controlled, typically allowing temperatures between  $-140^{\circ}\text{C}$  and  $-80^{\circ}\text{C}$ . An airlock system fitted to the microscope allows easy and quick sample transfers without venting the microscope chamber.

An anti-contaminator or cryo-shield sits directly above the cryo-stage and is essential in both the cryo-preparation chamber and the cryo-microscope to prevent contamination of the specimen surface. These anti-contaminators are relatively large in size and must be colder than the sample itself, making them the most probable target for condensation contamination.

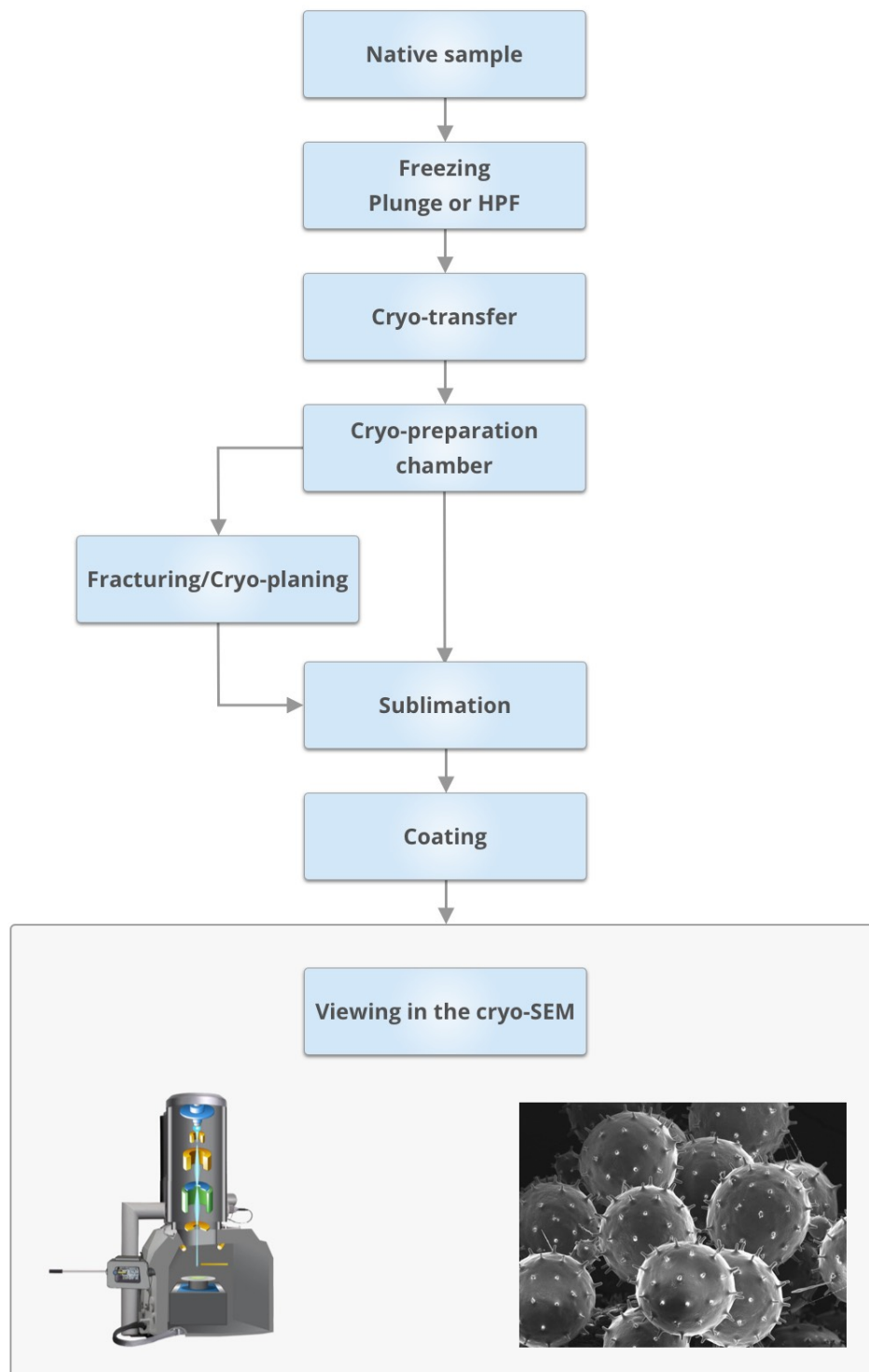


# Sample preparation – Freezing & cryo-transfer

Sample preparation for cryo-SEM is relatively quick and simple and consists of 4 main parts:

1. the freezing
2. the transfer of the frozen samples
3. the sublimation of the sample surface to expose the structures of interest
4. the coating.

If you want to expose the inside of your sample, then fracturing or cryo-microtomy will be needed prior to the sublimation.



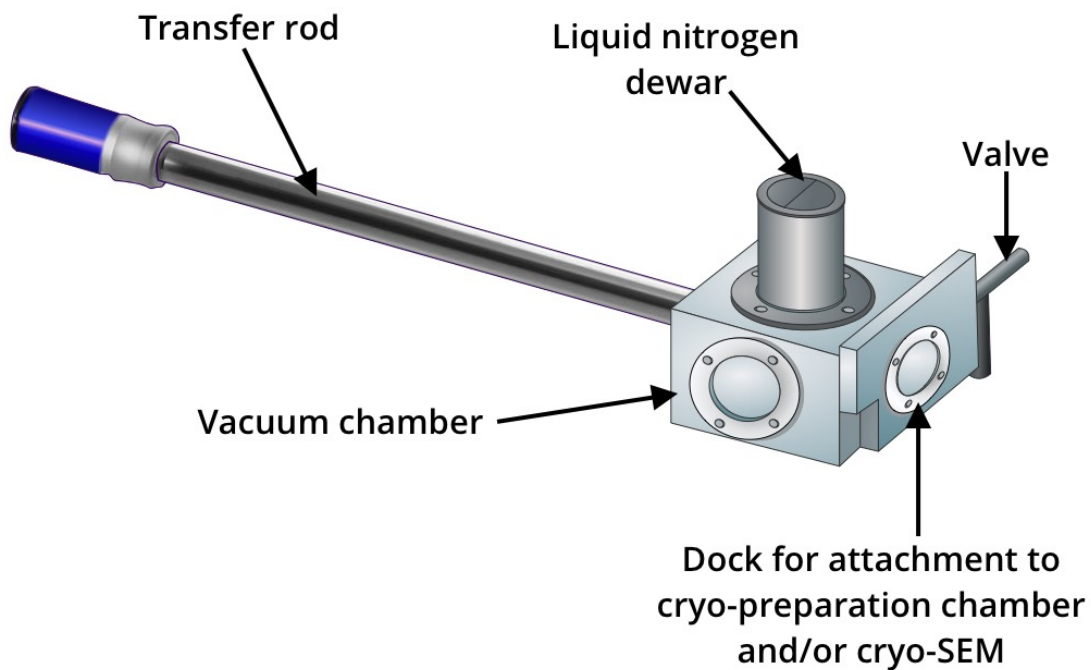
*Workflow of sample preparation for cryo-SEM.*

## Freezing

Vitrification or freezing as described elsewhere in this cryo-module is applicable to cryo-SEM as well. So, both plunge freezing into a cryogen like liquid propane or liquid ethane or high-pressure freezing are usually the methods of choice to achieve sufficient quality of freezing. However, many samples, like leaves, petals or insects, that possess water retaining surfaces like cuticles can be plunged directly into liquid nitrogen, even though freezing is comparably slow. For studies that are performed at relatively low magnifications and only observe the sample surface, this slower speed of freezing is acceptable. For a better quality of freezing, a nitrogen slush is often used in cryo-SEM. This 'slush' form is created by placing liquid nitrogen under vacuum and with its higher latent heat and lower temperature of  $-210^{\circ}\text{C}$ , a faster rate of freezing is achieved, relative to liquid nitrogen.

## Cryo-transfer

A cryo-transfer device or shuttle is used for moving the sample between the different parts of the cryo-preparation workflow. It can dock mechanically to each instrument. In basic systems the sample is plunge frozen while sitting on the end of the transfer device and then moved directly to the cryo-preparation chamber and ultimately the cryo-SEM. More advanced systems actively keep the sample cold and under vacuum throughout the entire process to ensure stability and cleanliness during the transfer process.



*Cryo-transfer device allows transfer of samples between cryo-preparation instruments and the cryo-SEM. The samples are kept cold and under vacuum at all times during the transfer.*

# Sample preparation – Fracturing and cryo-planing

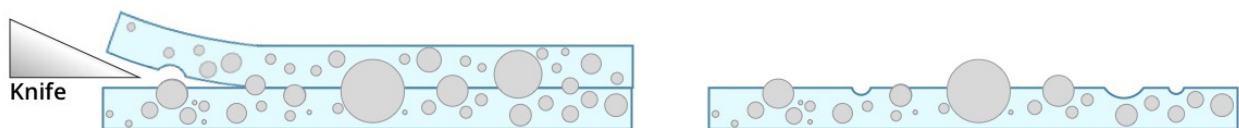
Unless the surfaces to be studied are naturally exposed it is necessary to fracture or cut through them to reveal an internal structure or to remove material that is not representative of the real sample. Generally, fracturing a frozen sample gives a much cleaner, sharper surface than that achieved by cutting a fresh sample with a sharp blade.

Unfortunately, with freeze-fracturing the path of the fracture plane cannot be controlled as it preferentially follows interfaces, such as the hydrophobic inner zone of the membrane lipid bilayer. In a complex system such as a cell, the plane of fracture frequently switches from one membrane bilayer to another, cross fracturing the cytoplasm between organelles and cell membranes, producing a semi-3D view of the cell structure.

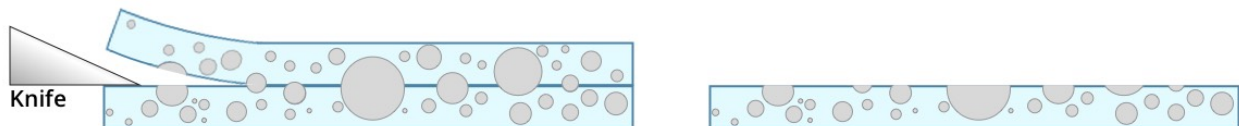
The fracturing device is usually a cooled tungsten knife or blade, either used manually or on a micrometre drive, and housed in the cryo-preparation chamber. Although the height of the fracture can be set within a micrometre, the frozen sample is brittle so it is difficult to be precise with the location of the fracture. However, it is possible to refracture the sample after initial observation to look sequentially at different planes with the sample.

If the plane of fracture needs to be controlled or the fractured face needs to be a flat surface, then another technique – cryo-planing – can often be used. Here the frozen sample is transferred to a cryo-ultramicrotome and the surface is planed in highly controlled steps (from micrometre to nanometre scale) using either a glass or cryo-diamond knife. With this, the region where the cross-section is prepared, can be precisely determined. Observation of the resulting flat surface yields information similar to that seen in the cryo-TEM with cryo-sectioned or cryo-FIB produced samples. Well-planed surfaces are essential for reliable accurate morphometry and elemental (X-ray) microanalysis.

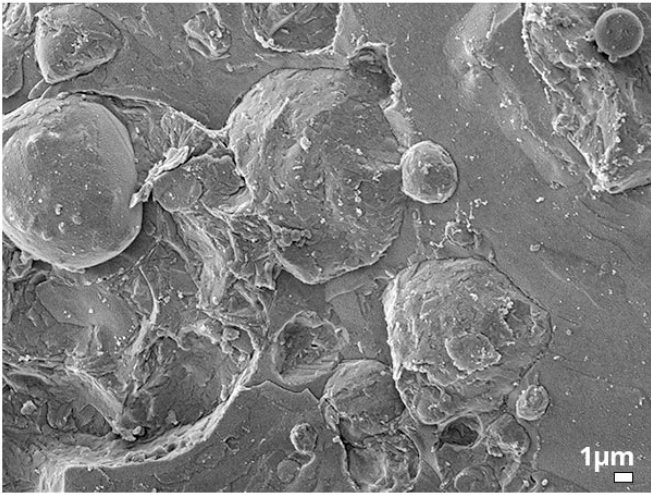
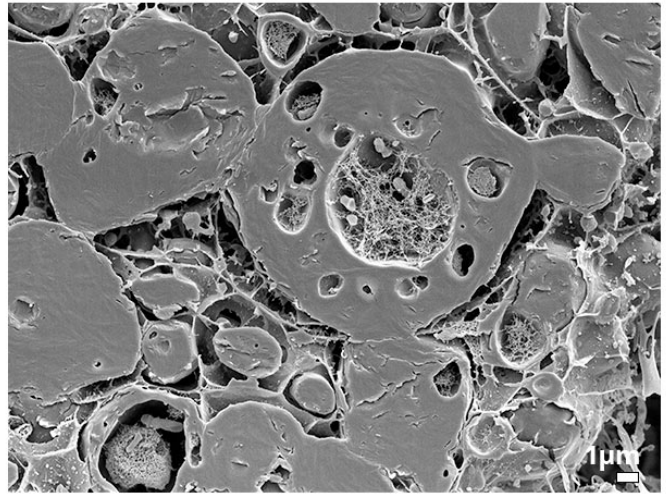
**A**



**B**



*A comparison of A. freeze-fracture and B. cryo-planing. In freeze-fracturing the fracture tends to follow the plane of least resistance, such as along the hydrophobic interface of membranes and then across the cytoplasm until it reaches the next membrane. Cryo-planing forms a smooth surface with no relief.*

**A****B**

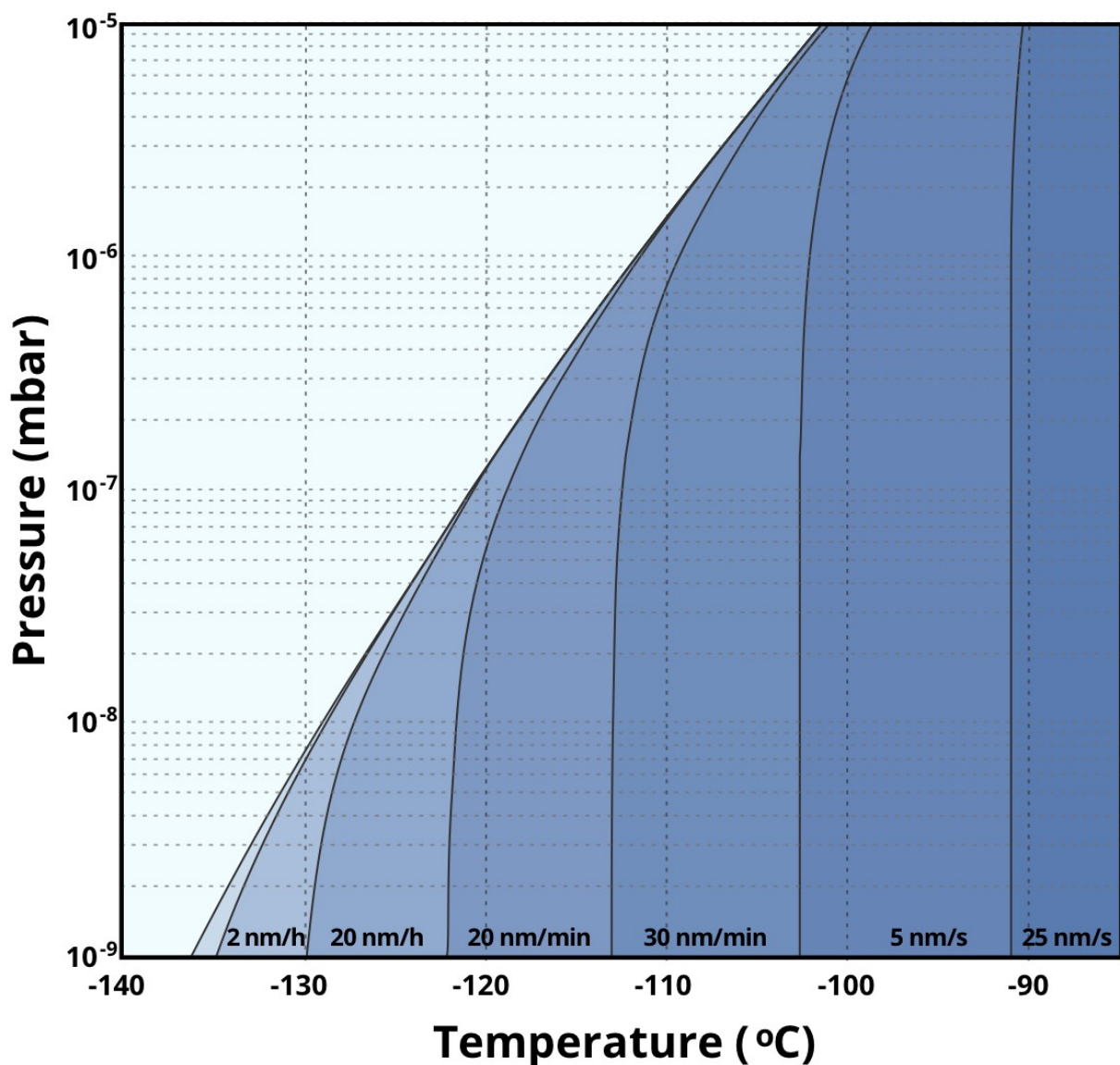
*A comparison of A. freeze-fracture and B. cryo-planing of the same sample. With freeze fracturing the sample shows some three-dimensional relief while the cryo-planing smooths the surface of the sample.*

# Sample preparation – Sublimation

This process of sublimation or etching has two important functions.

1. During freezing and transfer, particularly with more basic systems, the sample surface can become contaminated with frost due to condensation of water on the cold surface. Sublimation removes this from the surface thus exposing the original sample structure.
2. This process creates surface relief and exposes structures within the sample to give a better view of the three-dimensional ultrastructure. In fractures through the sample, membranes in particular are left raised up and so show cellular organisation.

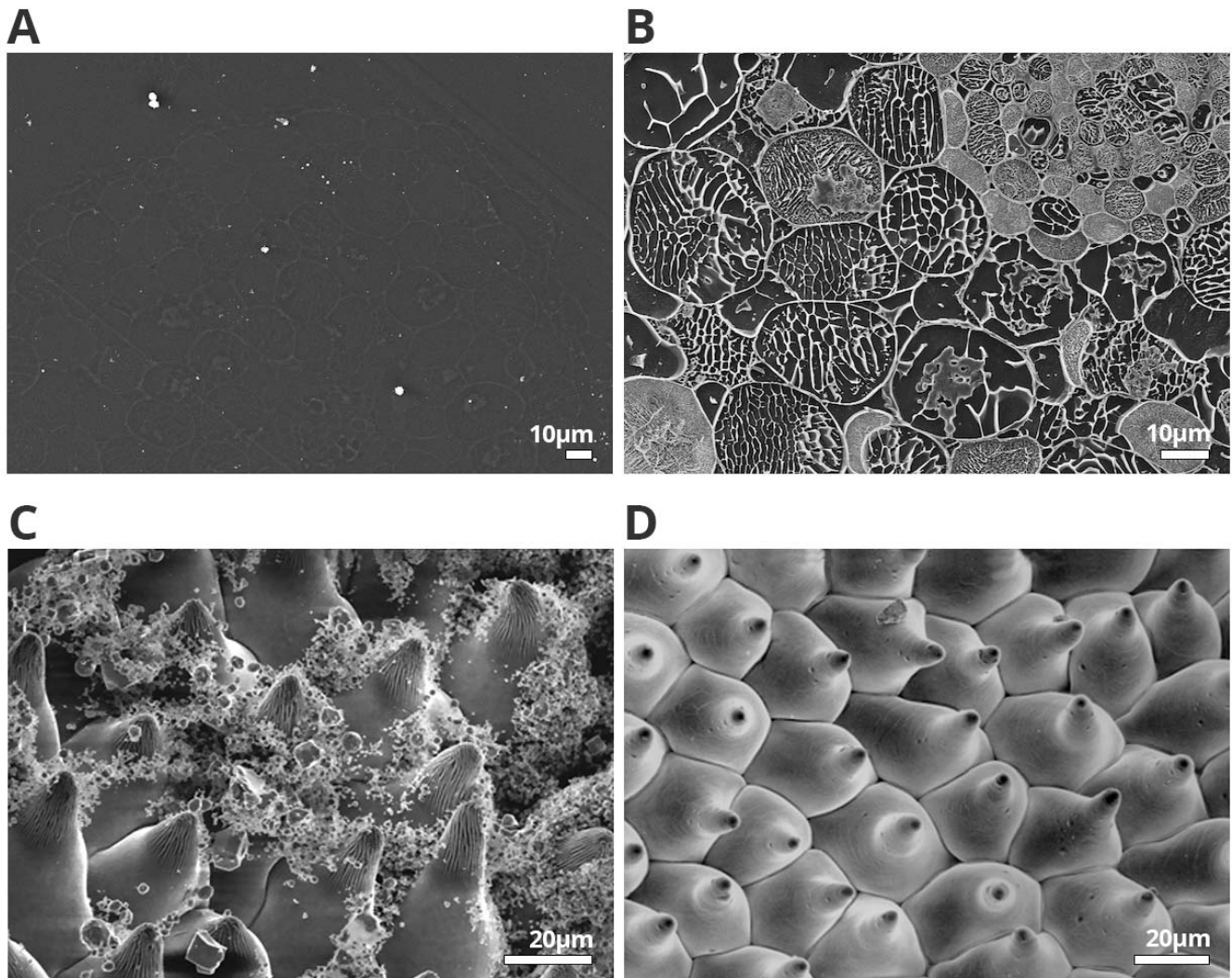
Sublimation involves highly controlled heating of the sample stage to temperatures around  $-90^{\circ}\text{C}$  to  $-110^{\circ}\text{C}$  and the rate is a function of both vacuum and temperature. On tungsten-filament-based cryo-SEMs, this can be performed inside the microscope while observing the sample so you can judge when the process is completed. This must be done carefully and at low voltages due to beam sensitivity and high signal-to-noise from the uncoated sample. Otherwise, the required temperature and time is usually determined empirically and undertaken in the coating or preparation chamber. When sufficient sublimation is achieved, the sample temperature is again lowered to stop the process. Taking this too far can lead to collapse of structures in the sample.



*Theoretical phase diagram for pure water showing the sublimation rates at different pressures and temperatures. Both poorer vacuum and increased temperature lead to an increased rate of the sublimation. Calculations are based on Umrath (1983) Mikroskopie 40, 9-37. Graph courtesy of Roger Wepf, University of Queensland.*

As soon as the process is complete the sample is either sputter coated with metal or evaporatively coated with carbon at  $<-130^{\circ}\text{C}$  in a suitable preparation system – as with room temperature SEM, the sample must be conductive for imaging.

On most modern cryo-preparation systems this preparation process is fully automated and both sublimation and coating profiles can be saved for future use.



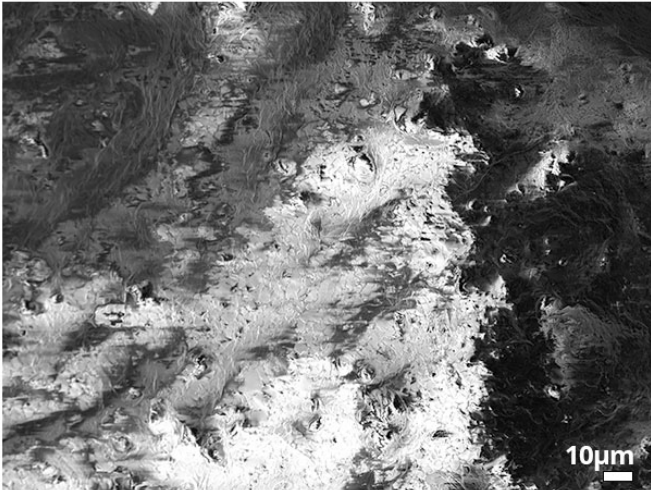
*A. A root of *Trifolium subterraneum* that has been cryo-planed and so shows no obvious structure. B. The same cryo-planed root after sublimation showing cellular structures. C. Sample covered with frost that condensed on the cryo-samples during preparation. D. The sample shown in C. after sublimation to remove the contamination. Images courtesy of Hua Chen, Australian National University and Patrick Hayes, University of Western Australia.*



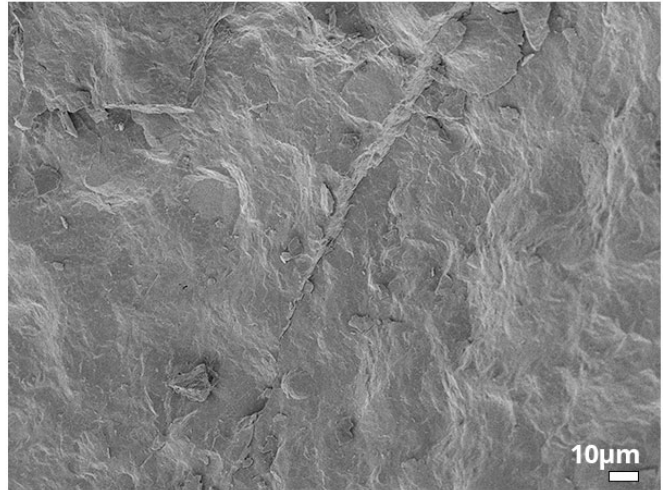
## Sample preparation – Coating

Biological samples are inherently difficult to observe in the SEM as they are composed primarily of relatively light elements such as carbon, hydrogen, nitrogen, and oxygen and are not naturally conductive. Cryo-SEM is no different – samples suffer from charging, beam damage, and poor signal to noise. To alleviate these issues samples are routinely metal- or carbon-coated. To achieve this, the frozen samples are coated with a fine layer (few nanometres) of either metal or carbon from a sputter coater and/or evaporative coater system built into the cryo-preparation chamber. This makes the samples conductive, protects them from beam damage, and produces secondary and back-scattered electrons to allow for good imaging quality. Metals such as platinum, gold or palladium are routinely used to give high-resolution imaging.

**A**



**B**



*Cryo-SEM imaging of sunscreen, uncoated (A) showing charging and coated (B) showing good quality imaging. Micrographs courtesy of Peta Clode, University of Western Australia.*

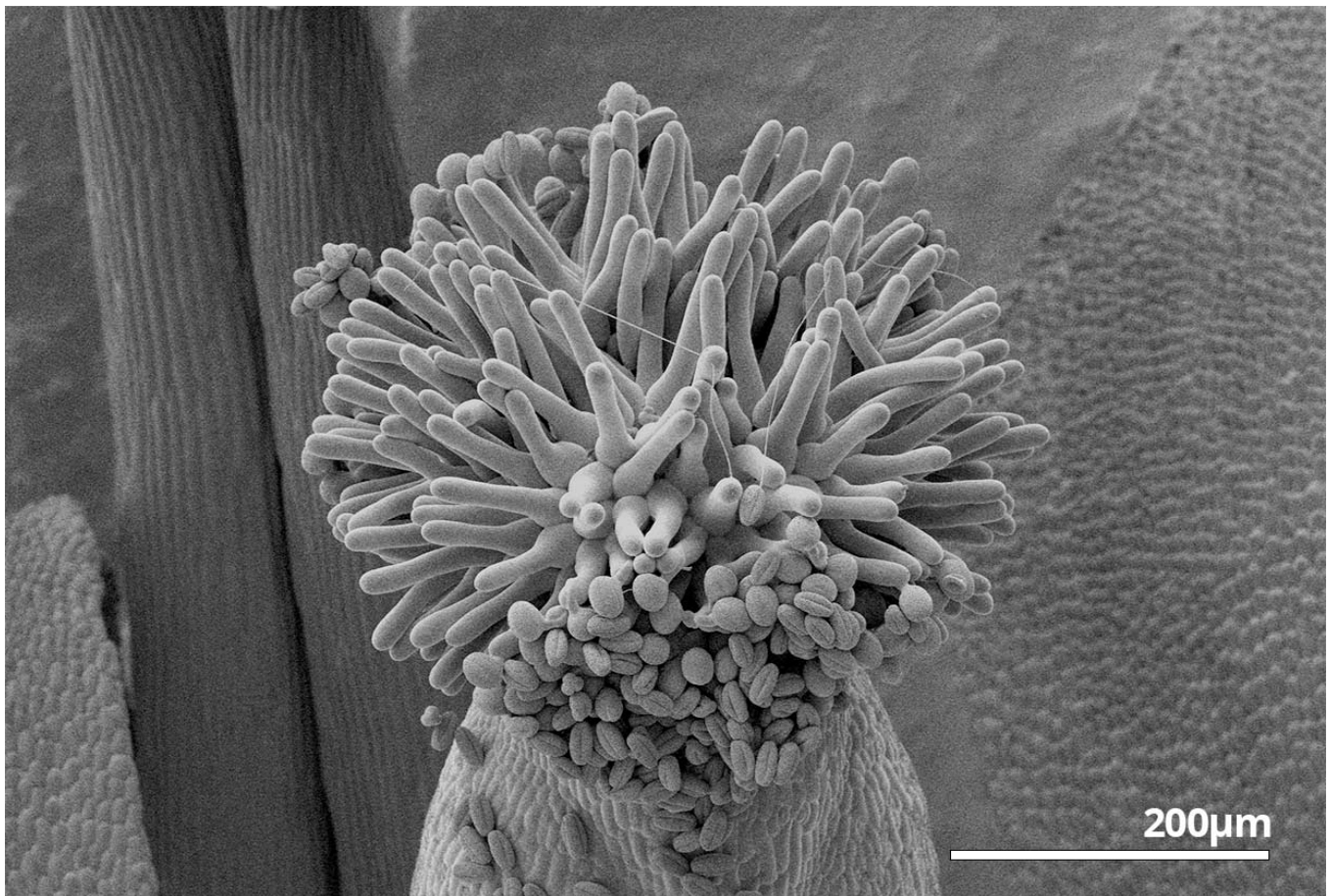
# Cryo-SEM operation

If you are unfamiliar with standard SEM you can refer to the SEM module for more information

As stated previously, insulating, uncoated cryo-SEM specimens exhibit little contrast, are unstable in the beam, and suffer from charge build-up, so coating of the samples is important. In the cryo-SEM, frozen samples are observed on the cryo-stage at temperatures usually at or below  $-140^{\circ}\text{C}$  to avoid any further sublimation from the sample. An anti-contaminator sitting above the sample and kept at a temperature below that of the sample, stage, must be used to prevent contamination. Both the secondary electron (SE) and the backscattered electron (BSE) detectors can be used in cryo-SEM. While low accelerating voltages are typically used for surface imaging, it is possible to use higher voltages (especially for backscattered electrons) on stable samples.

When deciding on the operating parameters of the microscope and adjustments that need to be made, you need to consider the following so you can acquire the relevant information from the sample.

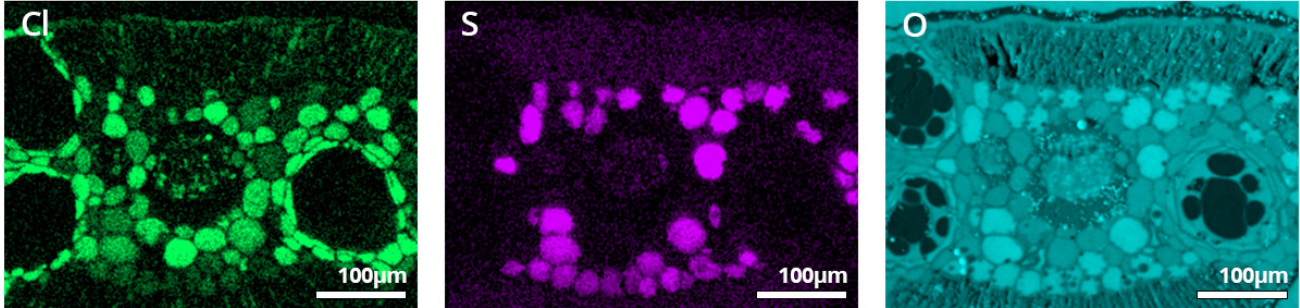
- Limiting sample charging (e.g. adjust beam current, scan rate, improve conductivity/coating)
- Avoiding beam damage (e.g. adjust magnification, beam current, and type of coating)
- Adjusting scan rate to optimise signal to noise (without inducing charging or damage!)
- Considering depth of field, especially for large samples
- Optimising for the information required (e.g. surface information = low kV & SE signal, compositional information = higher kV & BSE signal).



Cryo-SEM image of the pistil within the flower of *Arabidopsis thaliana*. Micrograph courtesy of Ryan McQuinn, Australian National University.

# Cryo-SEM microanalysis

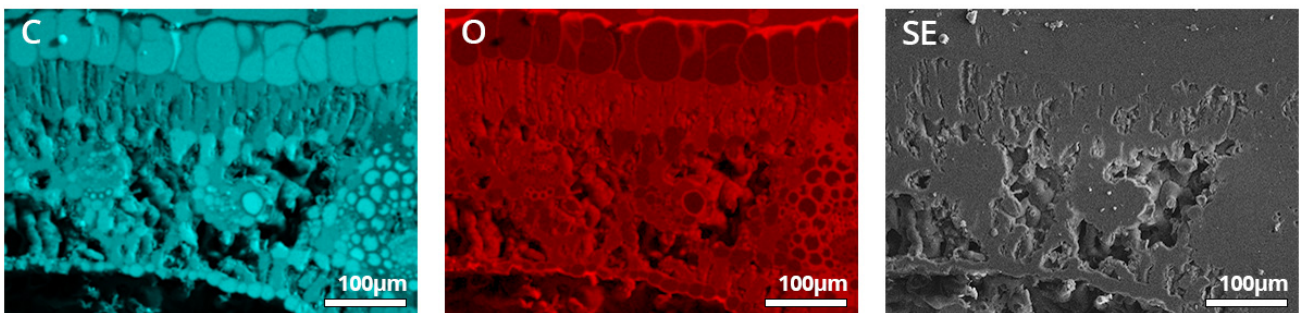
Frozen-hydrated samples are the gold standard when doing elemental analysis as there is almost no chance of redistribution or loss of elements – as the sample has simply been rapid frozen, with no or very minimal sublimation. In biology many of the constituent elements, particularly the light elements, diffuse easily and by any other sample preparation there will inevitably be some movement or loss of elements from the sample.



Chlorine, sulphur and oxygen elemental maps of a cryo-planed leaf of *Melaleuca systena*. The O map is used to show the plant structure. Images courtesy of Caio Guilherme-Pereira, University of Western Australia.

Energy dispersive X-ray microanalysis (EDS) is capable of both qualitative analysis, to determine the presence or absence of elements, and fully quantitative analysis, to determine element concentrations. Element concentration in frozen-hydrated samples is given in terms of  $\text{mmol kg}^{-1}$  wet weight, which is much more biologically meaningful than concentration in terms of dry mass, which is obtained by other common analytical methods.

Cryo-fracturing of the sample is sufficient for qualitative results, but a near-perfect flat sample surface is needed for reliable quantitative analysis. This is because topography dramatically affects X-ray detection, especially of light elements. Cryo-planing, as previously discussed, produces a highly polished, flat sample surface well suited to quantitative analysis but these don't show any structural information. As carbon and oxygen are found in differing concentrations in different biological structures, maps of the distribution of these elements can be particularly useful for revealing the underlying structure. However, with great care of temperature and time control during sublimation, surface features can also be exposed in order to recognize the structures being analysed while having little effect on elemental concentrations.



Carbon and oxygen elemental maps of a cryo-planed leaf of *Grevillea thelemanniana* showing the underlying cellular structure that is not readily obvious in the secondary electron image. Images courtesy of Peta Clode, University of Western Australia.

To prevent charging without compromising analytical results, the frozen samples should ideally be coated with a material that does not have X-ray peaks that overlap with the elements of interest. Common examples include carbon, aluminum, or chromium. In biology, an accelerating voltage of 15 kV is sufficient to excite most X-rays of interest (including Mn, Fe, Cu) and offers approximately  $2\mu\text{m}$  analytical resolution.

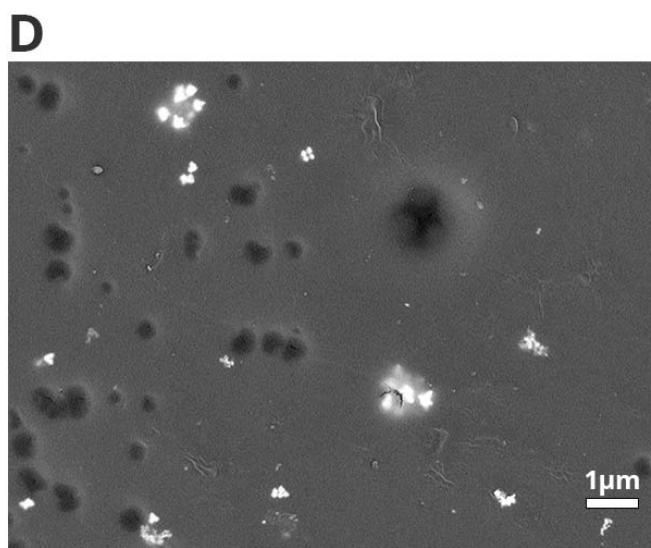
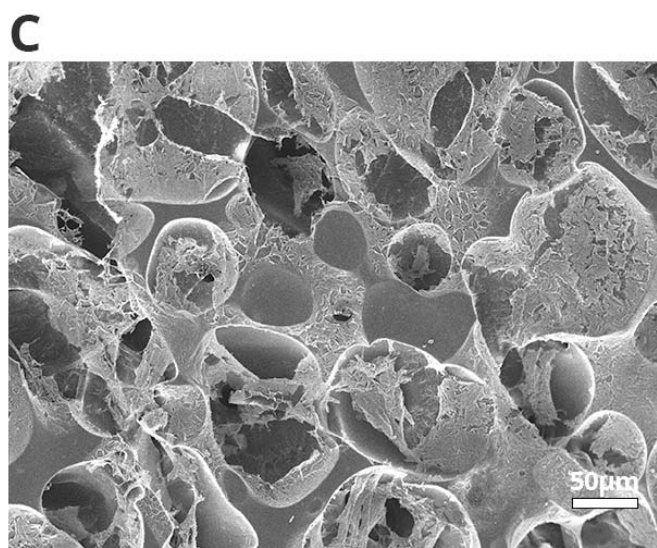
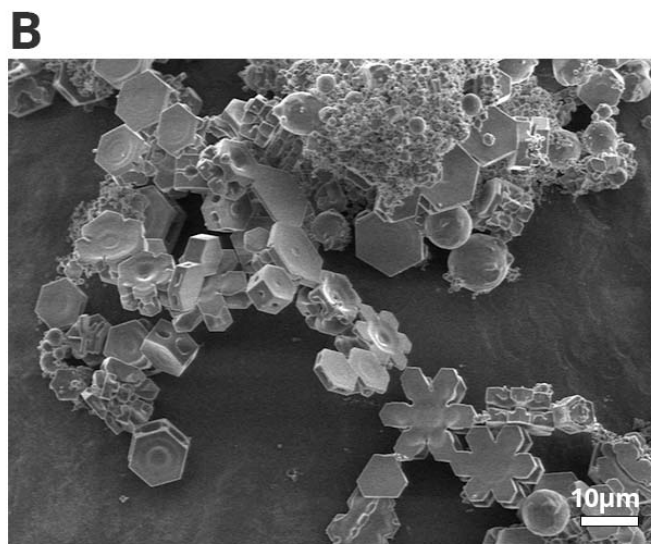
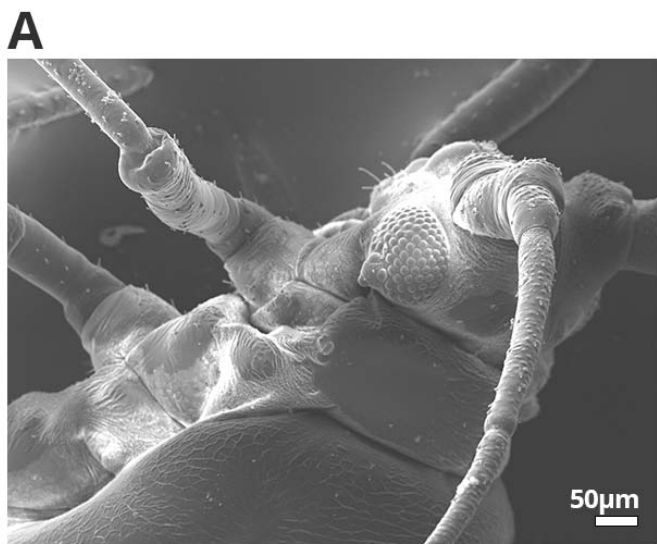
# Cryo-SEM artefacts

You need to be aware that artefacts can be introduced at any stage of the workflow in preparing and observing samples in cryo-SEM. The initial freezing and preservation of the sample is the most important step. As SEM samples can be quite large, it can be difficult to achieve vitreous (ice crystal free) preservation throughout the entire sample. However, if you are only observing the outer surface, this is less of a problem than if you are looking at fractured or internal surfaces. When the freezing rate is slow, ice crystals can be large and damage or destroy the sample microstructure.

Another important source of artefacts in cryo-SEM images is contamination. Because the sample is very cold, contaminants from the environment readily precipitate on the sample surface. Contaminants may originate in the microscope, such as hydrocarbons from oils used in the vacuum system, from the sample itself, such as water molecules that sublime from the sample surface, or from the air (e.g. water/frost). Contamination can be reduced with careful handling of the specimen and by the use of anti-contamination devices.

Below is a table of other artefacts and common causes:

<b>Artefact</b>	<b>Cause</b>
Breaking or cracking	Temperature or pressure shocks
Masking of fine detail	Frost, redeposition of sublimed water
Segregation or separation of components	Ice crystal formation during freezing
Collapse of structure	Poor control of sublimation
Deformation	Fracture or pressure damage
Bubbling or deformation/changes during observation	Localised beam damage



*Artefacts encountered in cryo-SEM work. A. Charging on an aphid sample. B. Frost contamination. C. Freezing damage on a hydrogel sample. D. Localised beam damage on a hydrogel containing silver nanoparticles, imaged with the back-scatter detector. Images courtesy of Victor Matsubara and Peta Clode, University of Western Australia*

# Cryo-FIB – Introducing cryo-FIB

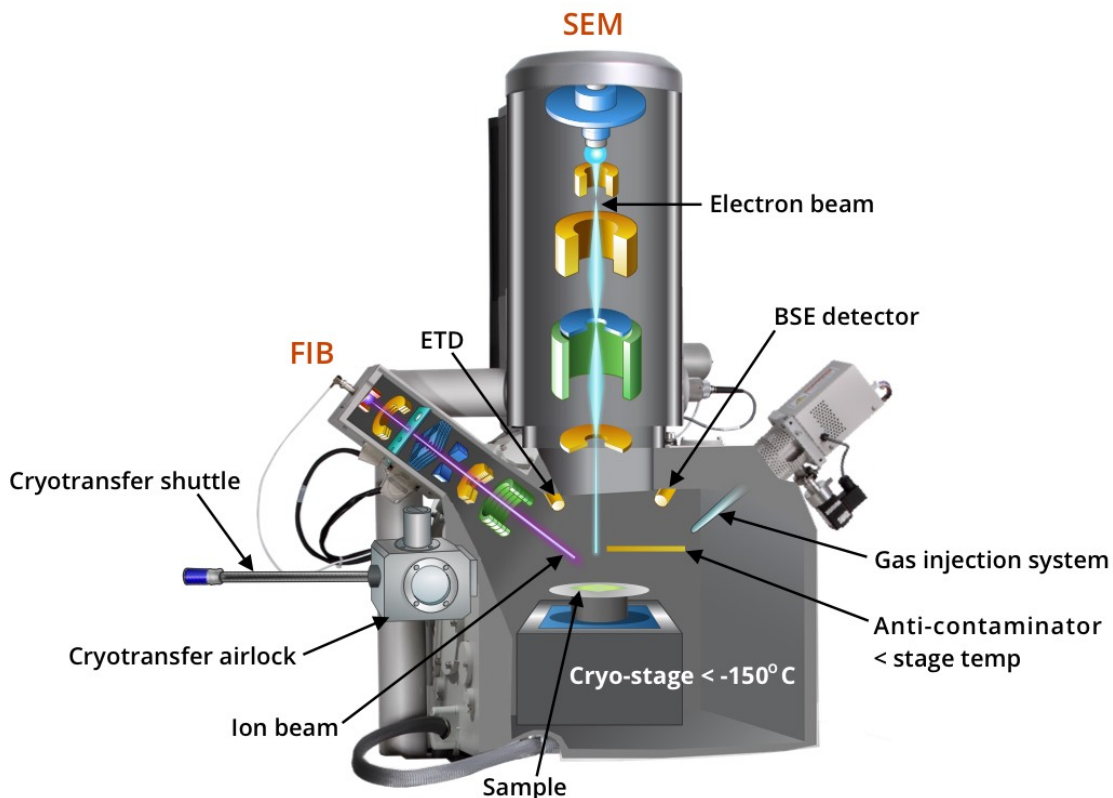
As described in the Focussed Ion Beam module, the FIB-SEM is an instrument that possesses two beams, an electron beam and an ion beam. The ion beam can be used to remove material from a sample with great precision, so it could be called a fabrication tool. While the sample is being milled with the ion beam, it can be imaged with the electron beam.

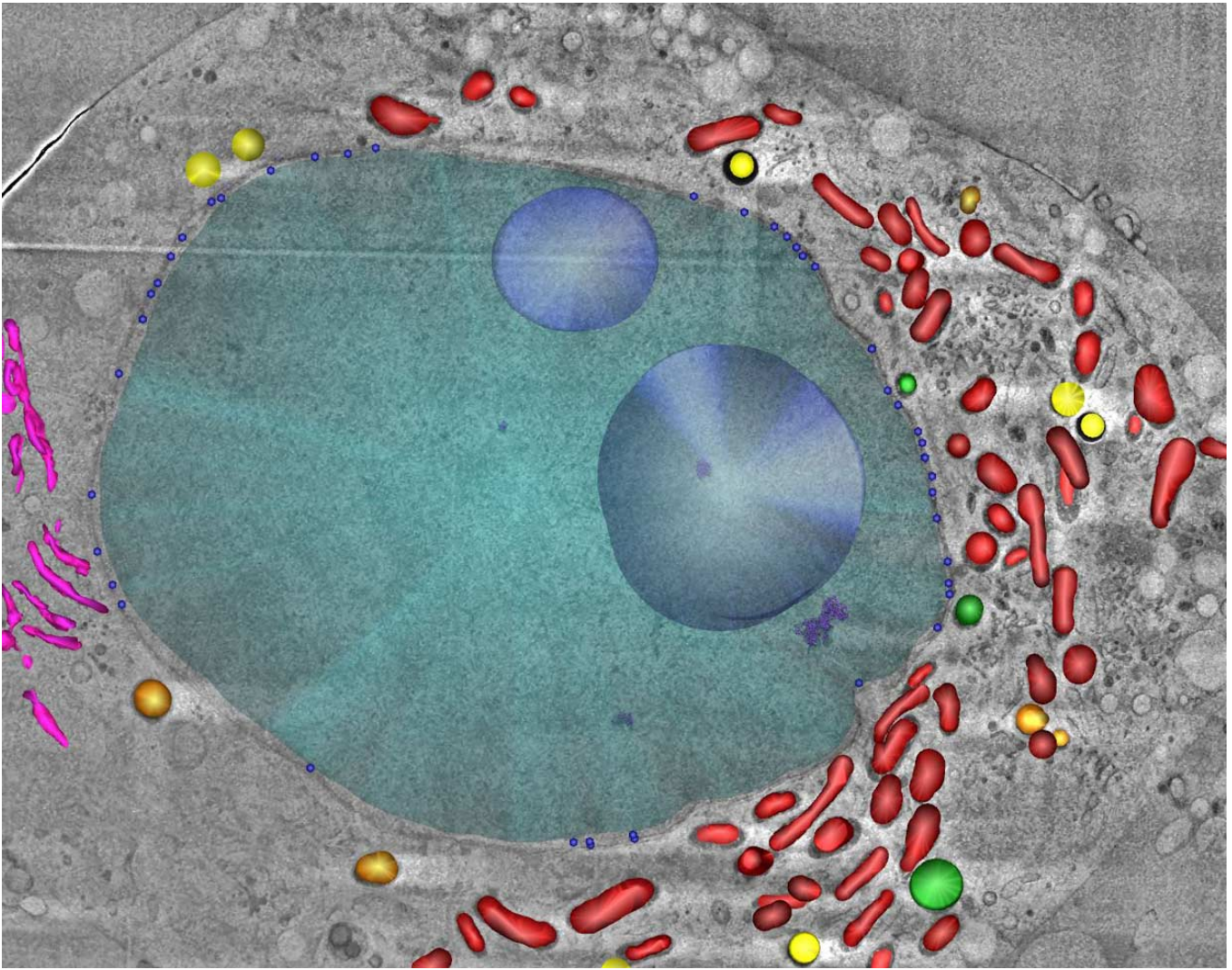
A cryostage can be fitted to the instrument so that the sample is kept at low temperature during these procedures allowing the possibility of working with vitrified biological samples. The cryo-FIB needs the following modifications over a standard FIB:

1. a cryo-stage to keep the sample cold, below  $-150^{\circ}\text{C}$
2. an airlock that allows attachment of the cryo-transfer device for quick sample changes
3. a cryo-shield, or anti-contaminator. This is a cooled piece of metal sitting above the sample that adsorbs all the residual water molecules in the chamber to prevent them from condensing on the sample surface
4. a cryo-transfer device or shuttle for moving the sample between the sample freezing device, an external cryo-preparation chamber and the cryo-FIB. This must be done under vacuum and while keeping the sample cold
5. a sputter coater, which can be either within the microscope or external
6. an external cryo-preparation chamber if facilities like sputter coating are not built into the cryo-FIB itself.

The two major applications for this technique are:

1. the preparation of thin vitrified samples for observation in the cryo-TEM
2. volume imaging to produce a 3D reconstruction of whole vitrified cells.

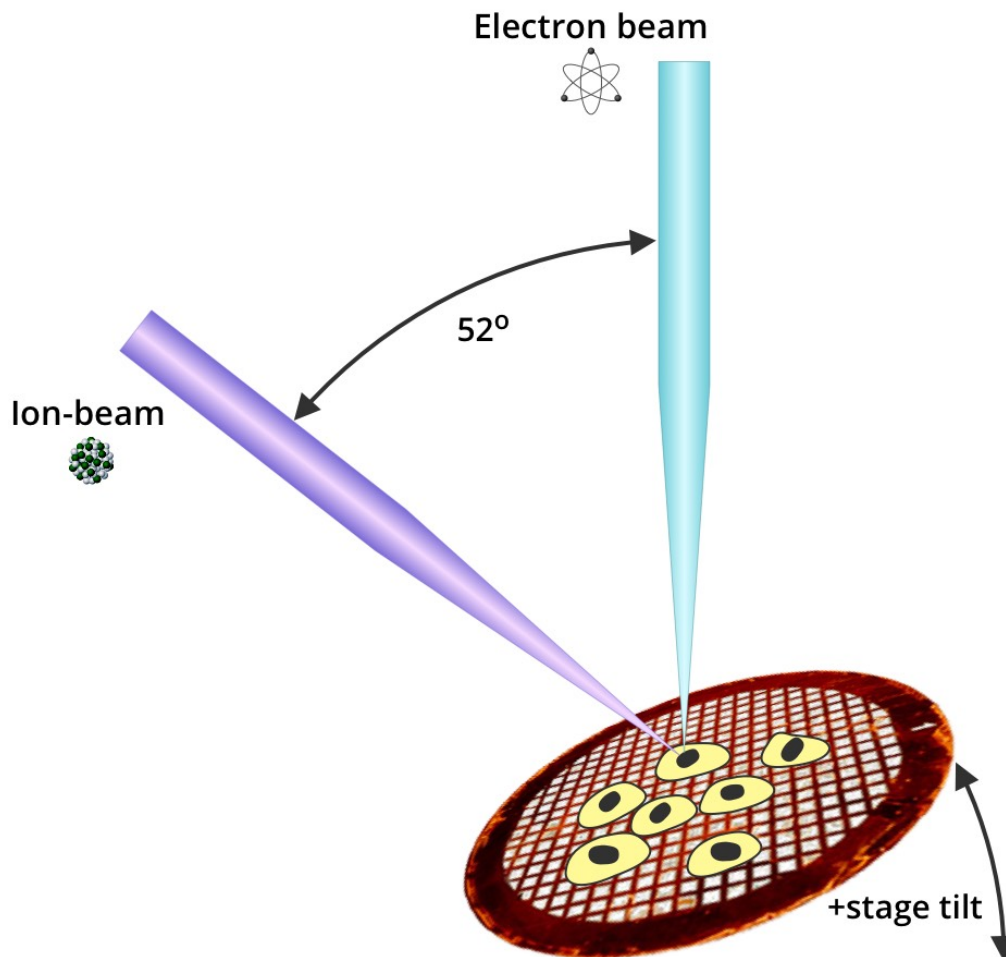




*Segmented data of a HeLa cell from cryo-FIB SEM volume imaging. Mitochondria (red), lipid bodies (yellow), multivesicular bodies (green), lysosomes (orange), nuclear pores (blue spheres), nucleus (transparent turquoise), nucleoli (transparent blue), nuclear speckles (purple). Image courtesy of Daniele Spehner, Institut de Génétique et de Biologie Moléculaire et Cellulaire, France and Anna Steyer EMBL, Germany.*

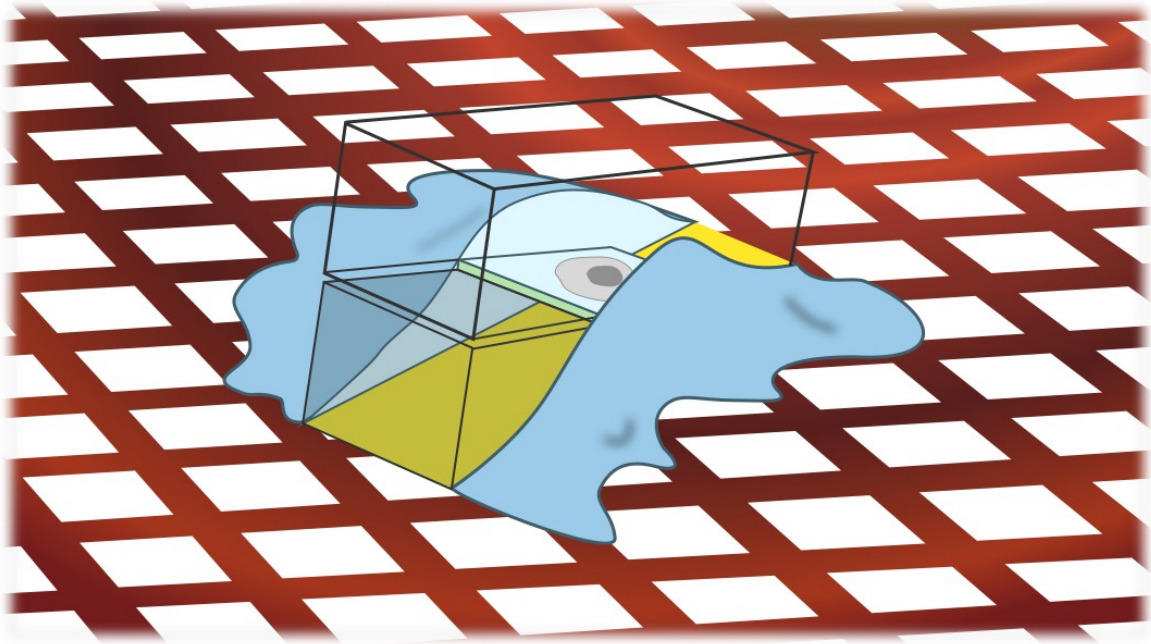
# TEM lamella production by cryo-FIB

Cryo-electron tomography (cryo-ET) is a ground-breaking technology for 3D visualisation and analysis of cells, even being able to show biomolecules in the context of cellular structures. However, high-resolution imaging depends on having thin samples. So, it's necessary to thin the vitrified sample down to a usable thickness and the cryo-FIB is the ideal tool for this. At present this is routinely possible with single cells such as mammalian cells, yeast or bacteria. Regions of the cell above and below this thin region of interest (ROI) are removed using the ion beam. This thin slice, called a lamella, is still supported by the remainder of the cell on both sides. Unfortunately, these lamellae cover only a small region usually less than  $10 \times 10 \mu\text{m}$  and  $<200\text{nm}$  thick.



*Orientation of the electron and ion beams onto the frozen cells on a grid to allow production of a lamella through the cell.*

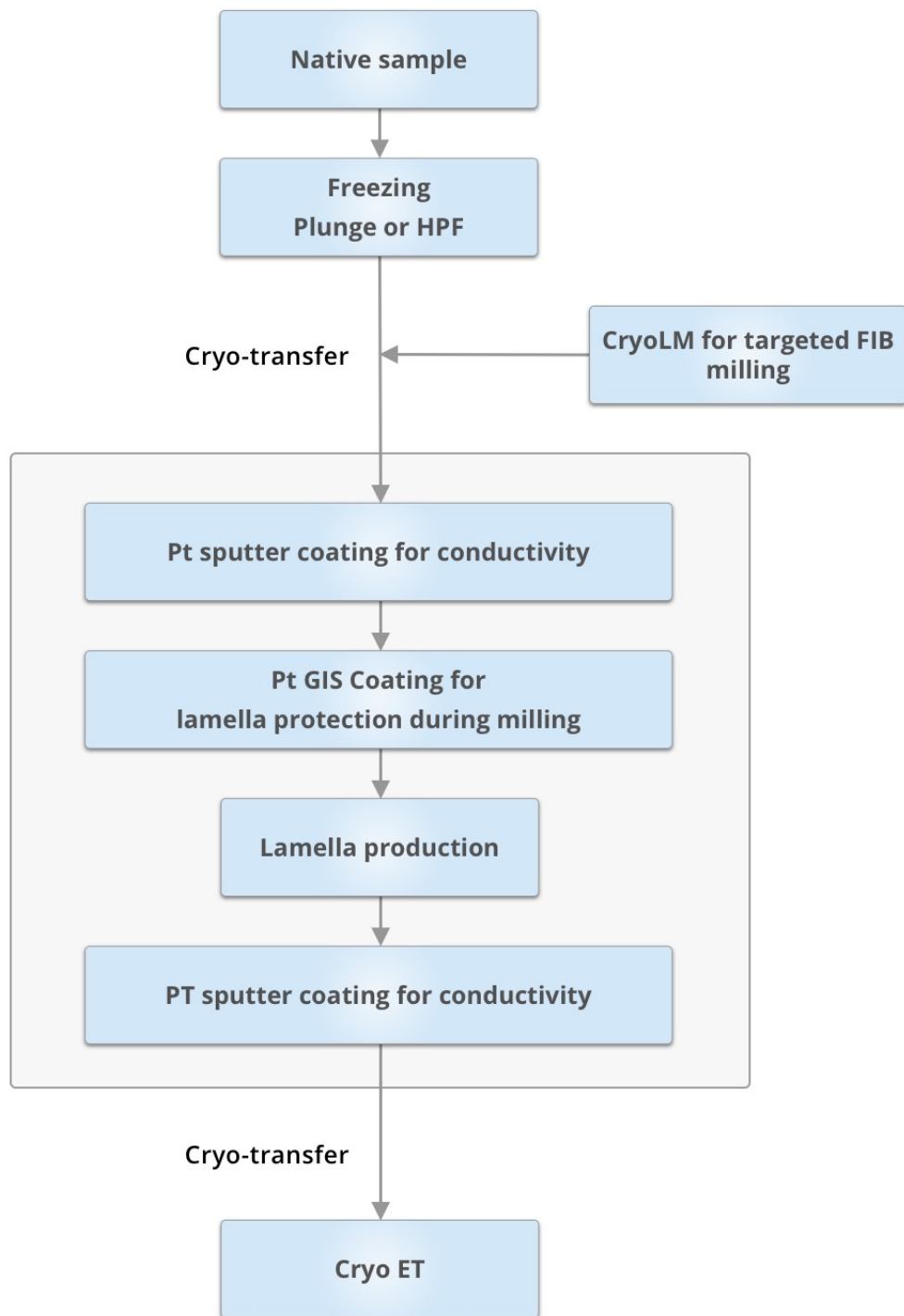




*Illustration of a lamella produced in a frozen cell grown on a grid. The black boxes indicate the material that has been removed.*

The procedure consists of:

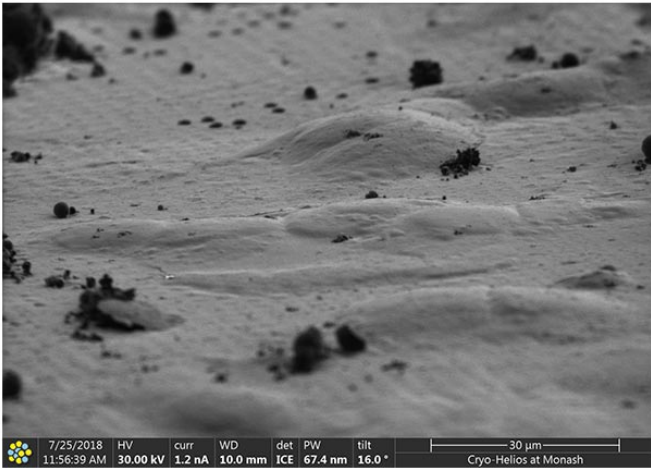
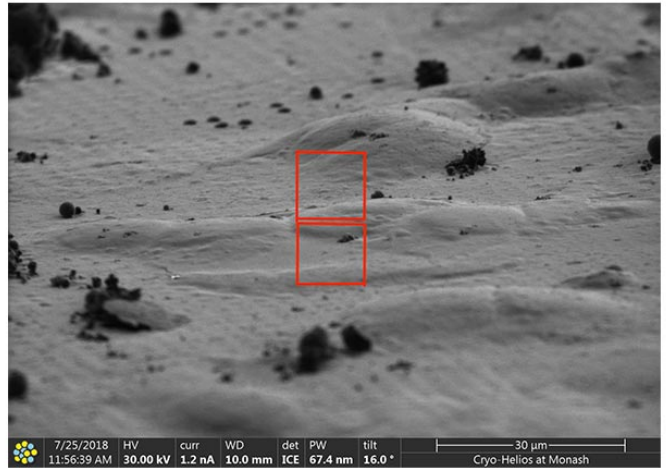
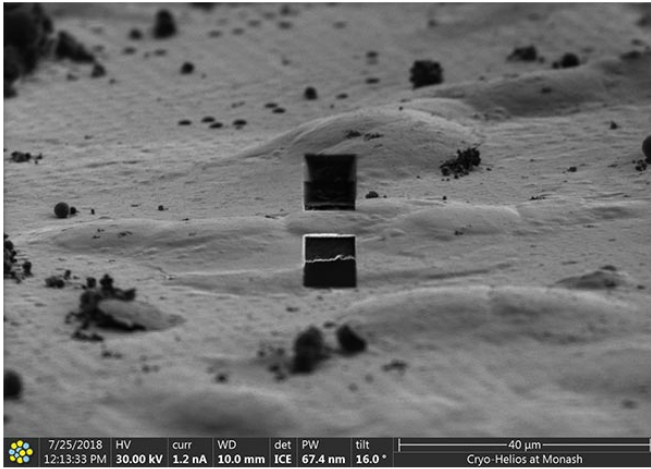
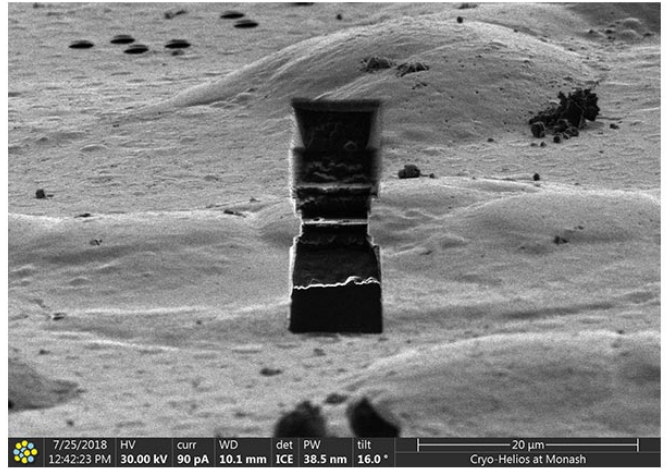
1. The cells are grown onto gold grids directly or a suspension is deposited onto a grid and the sample vitrified by plunging into a cryogen. To prevent damaging the cells, only the backside of the grid is blotted prior to freezing.
2. Using an external cryo-preparation system, the vitrified cells on grids are transferred to a cryo-shuttle and inserted into the cryo-FIB. The samples can be platinum sputter coated here or in the FIB itself to avoid charging effects during imaging in the microscope.



**Pt sputter coating could also be done in an external cryo-preparation system**

*Typical workflow of cryo-FIB lamella production from cells grown on grids.*

3. The cells are imaged and the region of interest is located. Using the gas injection system (GIS) a thick layer of platinum is deposited on the region to be milled to avoid curtaining artefacts and to give structural support to prevent the lamella from cracking during subsequent handling.
4. It's important to work out the geometry of the stage and adjust it to ensure that the region of interest will be within the milled lamella. Micro-expansion joints are often made either side of the lamella position to improve stability. Lamella milling can broadly be divided into three phases: initial rough milling to take away most of the cell above and below the lamella, thinning to about 400 nm thickness, and final milling or polishing to the target thickness which is usually around 200nm. The ion current is decreased as milling progresses to improve precision and avoid sample damage.
5. By use of the cryo-shuttle system, the grid can be transferred to the cryo-TEM for ET studies. Another sputter coating of platinum can be added to reduce charging in the TEM.

**A****B****C****D**

*Production of a lamella in a cell on a grid. These images are taken using the ion beam so look directly along the lamella in the tilted sample. The red boxes in B. represent the regions to be milled with the ion beam. Images courtesy of Gediminas Gervinskas, Monash University.*

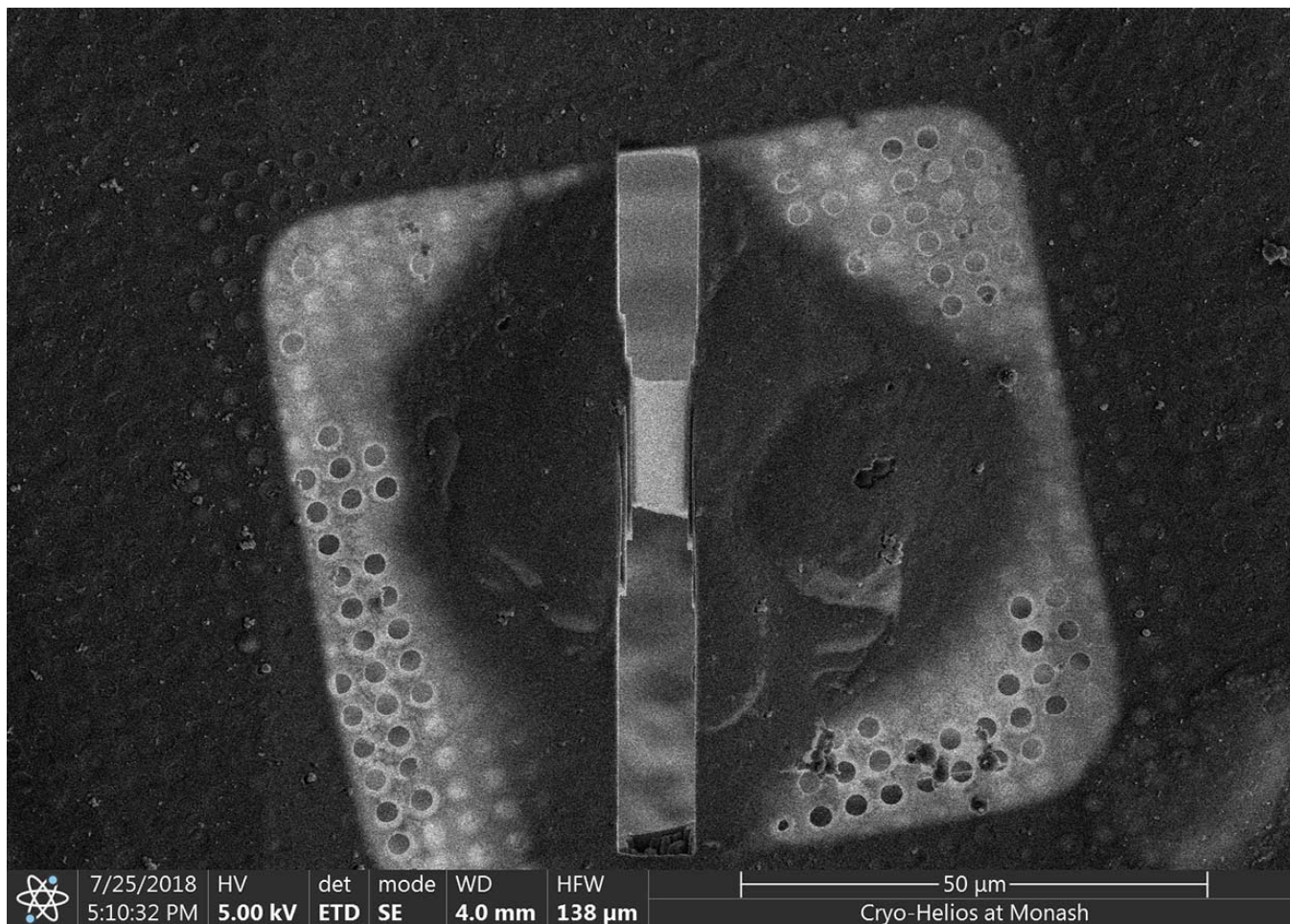
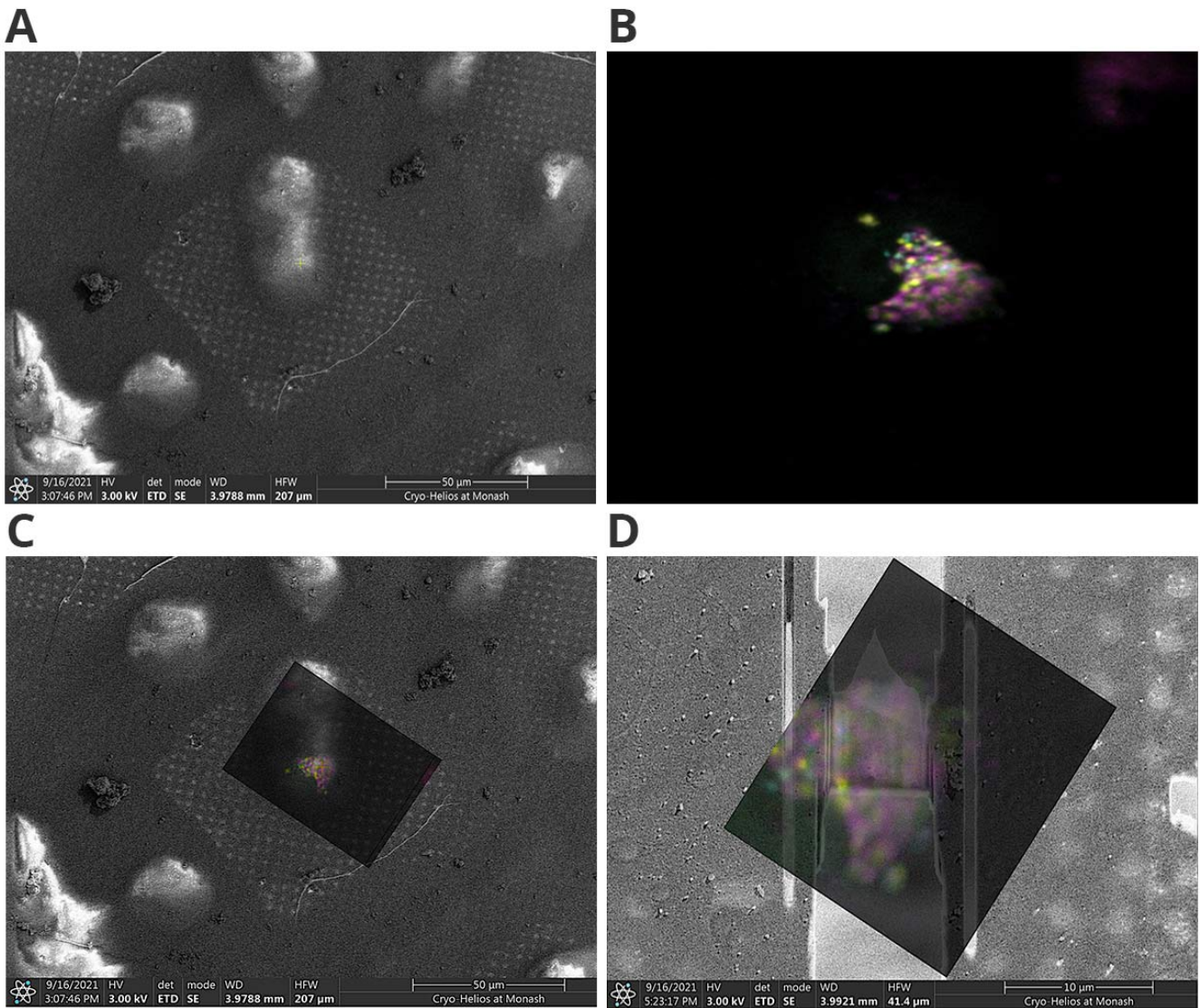


Image of a lamella using the electron beam, so looking directly face-on. Image courtesy of Gediminas Gervinskas, Monash University.

As the amount of material within a lamella is so small, it is important to ensure accurate targeting of the ROI. By using fluorescent markers within the cells, the organelle or protein of interest can be located under a cryo-light microscope. This information is transferred to the cryo-FIB as a guide for targeted milling.

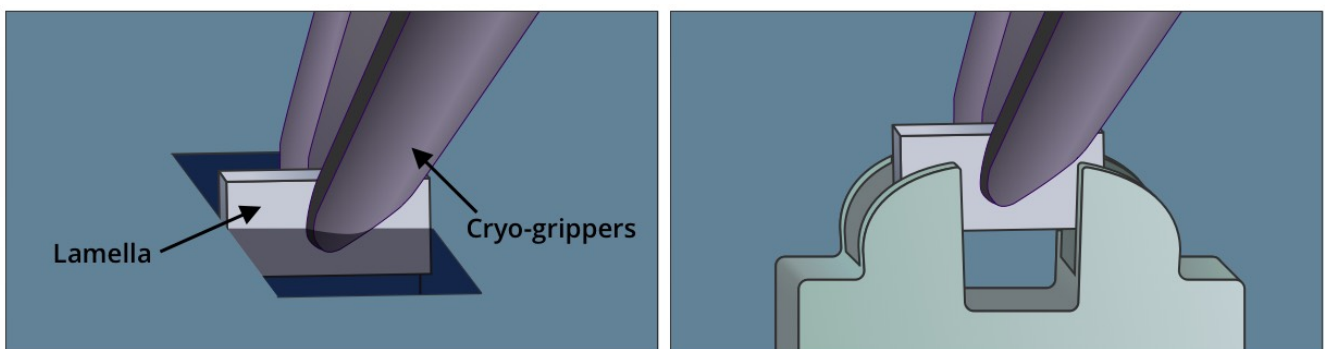
Cryo-light microscopes have now been incorporated into the cryo-FIB for easy localisation in situ. As the lamella is only around 200nm thick and the cells can be several micrometres deep it is important to also know the location within the depth of the cell. Confocal z-stack images obtained from a cryo-LM give this information to allow aligning the angle of the milling to retain the ROI within the lamella.



*Correlative cryo-LM-cryo-FIB. A. The cell of interest imaged in the FIB with the electron beam. B. The cryo-fluorescence LM image of the same cell. C. Overlaying the cryo-fluorescence LM image over the FIB image to show the region to be milled. D. Overlaying the cryo-fluorescence LM image over the FIB image of the lamella shows that the ROI has been captured in the lamella. Images courtesy of Gediminas Gervinskas, Monash University.*

Automation of the entire milling process means that milling of many lamellae at specific sites on the one grid can be prepared within a relatively short period of time.

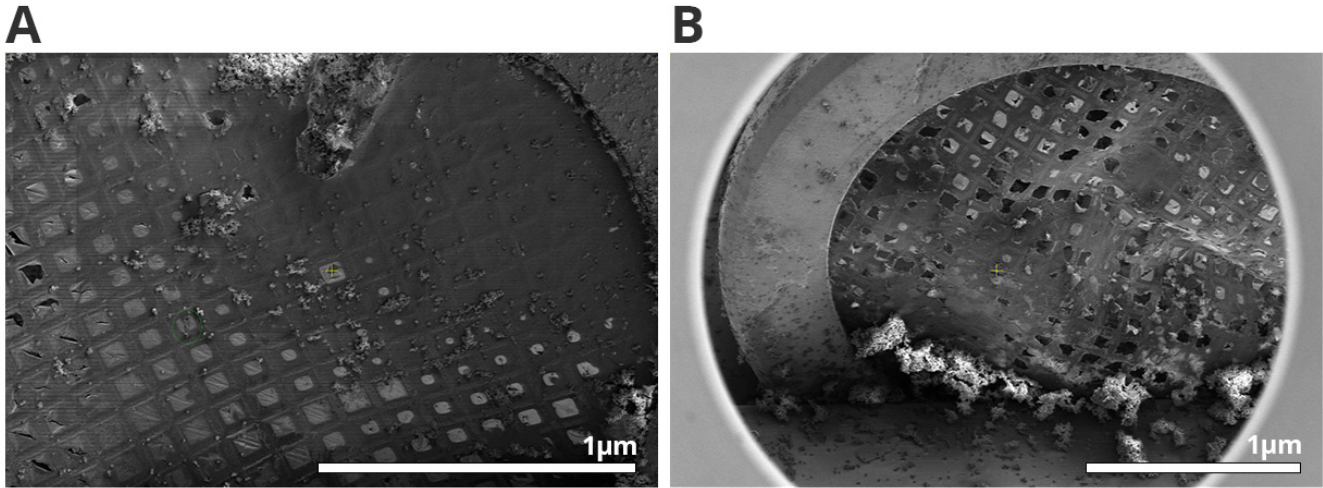
Tissue samples are high-pressure frozen, the entire planchette is transferred to the cryo-FIB and a thin lamella is produced at the ROI. Using micro-manipulated cryo-grippers this lamella is picked up from the sample and transferred to a specifically designed grid where it is welded into place.



*Cryo-FIB lift-out. The lamella is produced in the high pressure frozen sample and removed with the cryo-grippers and placed into the slot in a modified grid. The lamella is then welded into place.*

The technique suffers from many different challenges:

- Ice contamination – during transfer and in the chamber, on the sample and on the lamella after milling
- Damage to the grid – the gold grids are very soft and fragile and easily deformed or bent
- Cracking – of cells away from the grid and of lamella during milling
- Contamination – material milled away can recondense on the sample surface
- Devitrification – allowing the sample to warm, like touching grid with warm tweezers, or losing high vacuum during conductive sputter coating deposition
- Over or under blotting – cells should just be covered with a thin layer of ice. If the ice is too thick it can be difficult to find the cells if too thin the cells can be damaged
- Correct angle and geometry for milling – in order to have ROI in the lamella
- Correct thinning – to get right even thickness and still have stable lamella
- Curtaining artifacts on the lamella – FIB current could be too high during milling, a very rough surface on the sample, when ice crystals accumulate, or Pt layer from the GIS is too thick.

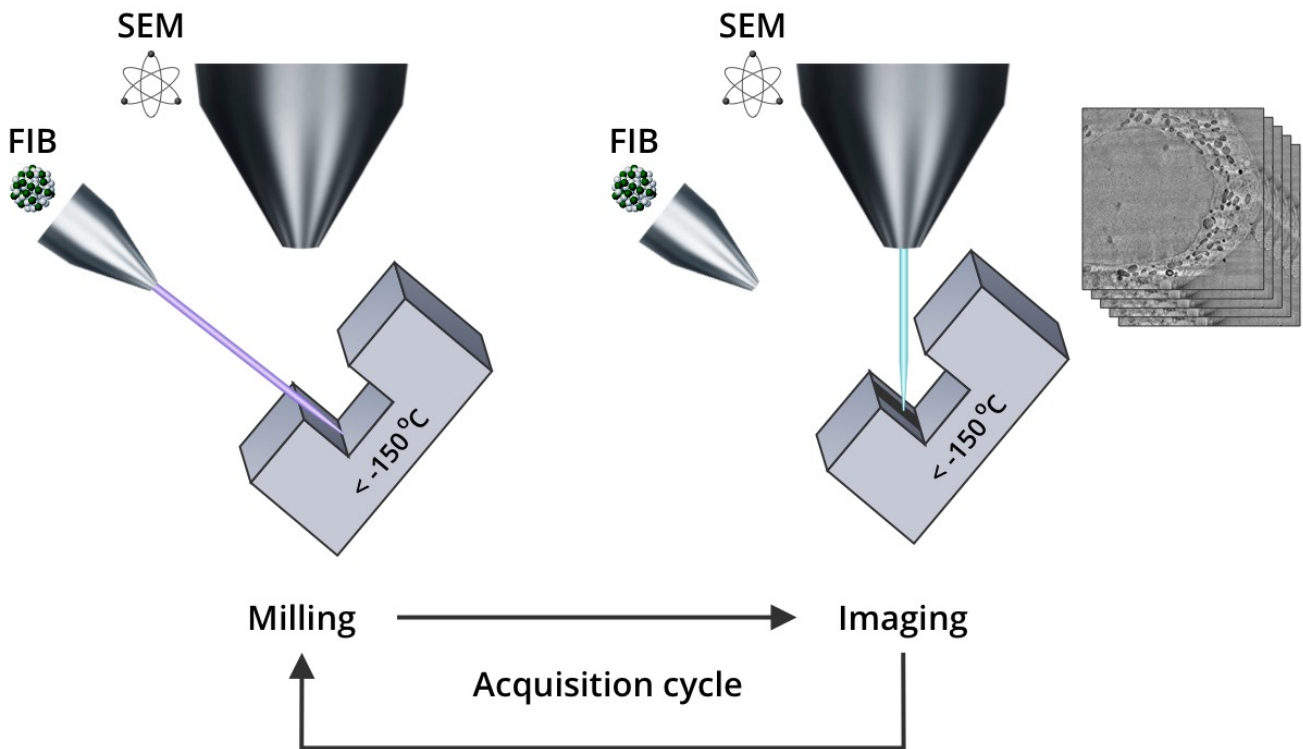


*Artefacts encountered with cryo-FIB work. A. The ice is too thick and has covered the cells. This is a result of poor blotting before the grid is plunge frozen in ethane. B. the grid has been bent during manipulation. The grids are made of gold and are extremely soft and easily damaged. Images courtesy of Gediminas Gervinskas, Monash University.*

# Cryo-FIB-SEM Volume Imaging

A 3D reconstruction of a sample can be generated by a continuous cycle of imaging the sample surface using the SEM beam and subsequent removal of a thin slice of material using the FIB beam. When this process is repeated over and over again, a stack of images is produced that, when combined, produce the 3D reconstruction.

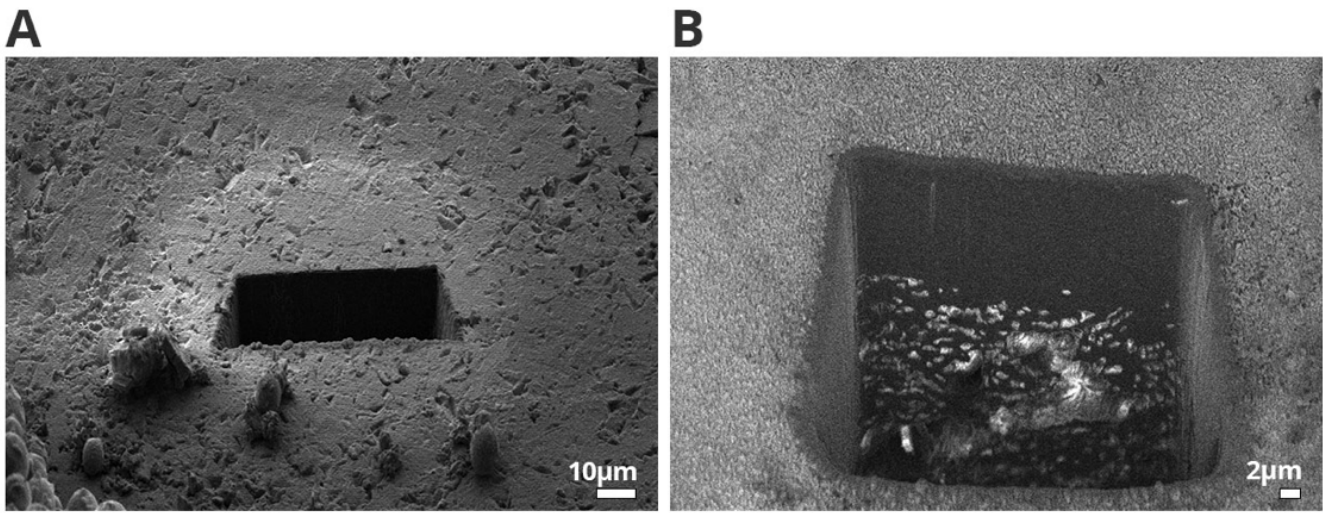
In the cryo-FIB-SEM it is possible to perform this volume imaging on frozen hydrated samples, allowing the interpretation of the cellular organisation of samples in their native state. This technique is called cryo-FIB-SEM volume imaging.



*Workflow for Cryo-FIB-SEM volume imaging with a continuous cycle of milling away small amounts of the frozen sample with the FIB ion beam and then imaging with the SEM electron beam.*

The workflow is quite direct so from freezing to capturing the first images of the sample can take only one to two hours.

1. Freezing - because of their relatively large size, the samples must be vitrified by high pressure freezing.
2. Transfer and coating - Using an external cryopreparation system, frozen samples are sputter coated with metal to make them conductive in the microscope, then loaded onto a shuttle for transfer to the cryostage of the cryo-FIB. Here the region of interest is coated with a heavy platinum layer to reduce curtaining artefacts, which produces lines across the images.
3. Imaging and milling - After finding the region of interest, the ion beam is used to excavate a trench into the sample with the imaging taking place on the polished wall of this trench. Low voltages between 1 and 3kV are used to reduce the radiation damage to the sample. Thin slices of material as thin as 30nm can be removed between each imaging cycle.



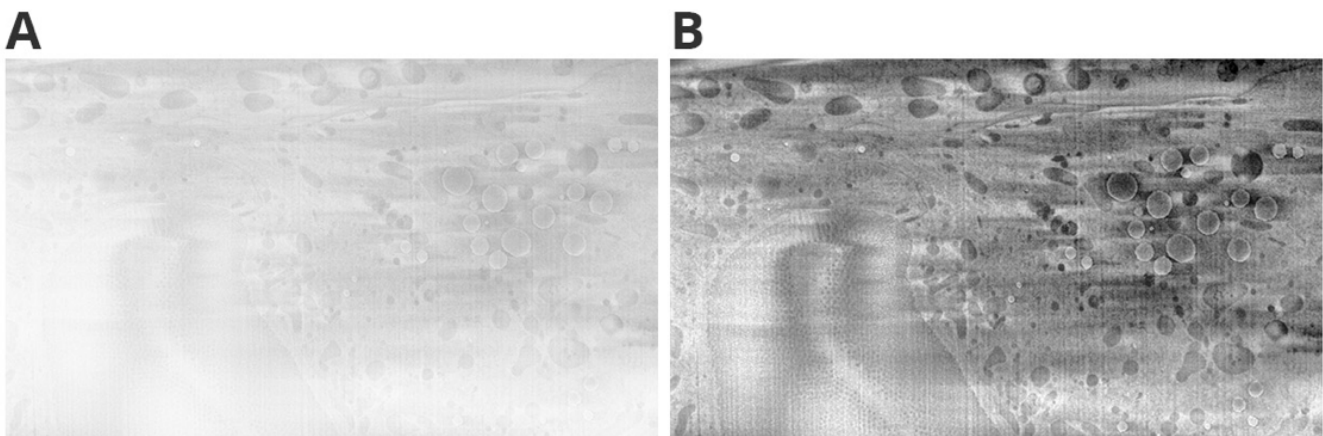
*A. Low magnification image of the trench milled into the surface of the frozen sample. B. Higher magnification image of a trench showing the sample to be imaged in the excavated blockface. Images courtesy of Daniele Spehner, Institut de Génétique et de Biologie Moléculaire et Cellulaire, France and Anna Steyer EMBL, Germany.*

As there are no heavy metals in the sample, the image contrast is produced from secondary electrons that come from differences in potential of the different chemical elements within the sample. These are collected using the in-lens SE detector. The images look remarkably like those achieved on stained samples in the TEM.

The technique could be combined with cryo-FIB lamella production to target a region of interest, which could be subsequently be studied by cryo-TEM tomography to acquire high resolution information about the same region.

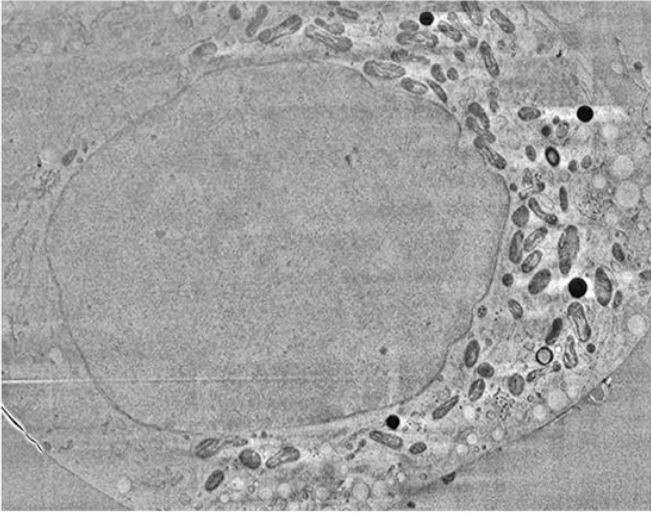
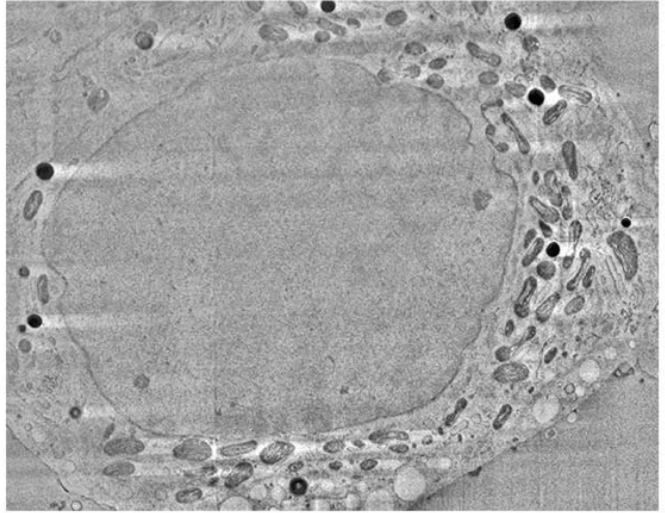
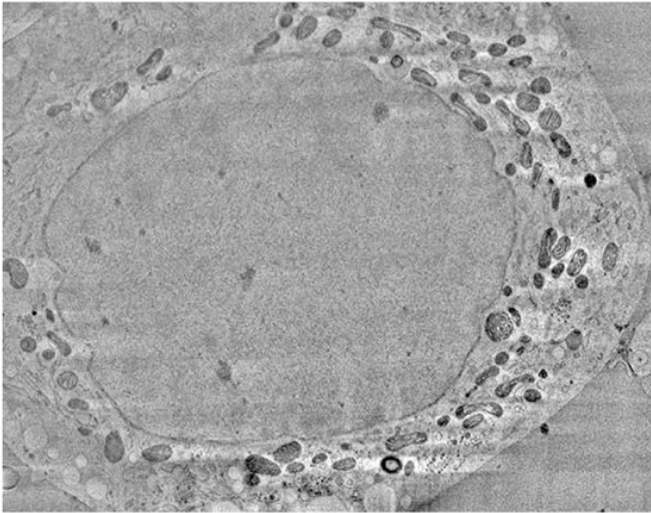
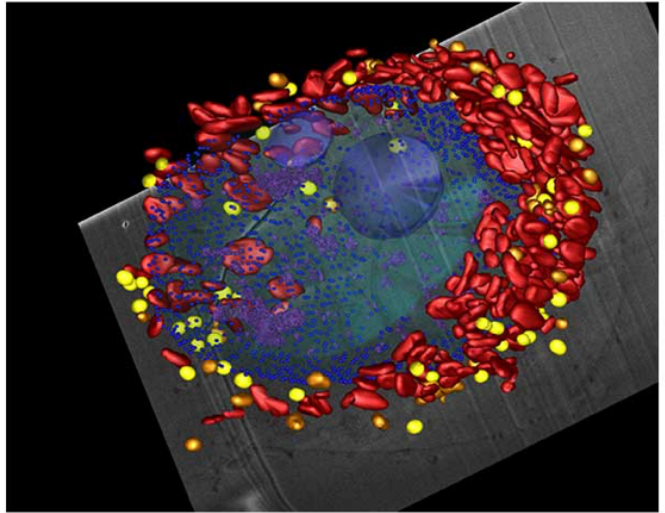
There are certain challenges associated with the technique, particularly related to beam sensitivity and imaging artefacts. This latter is caused by residual charging and curtaining and the poor SNR. Images need substantial processing after capture.

Despite showing great promise, this technique it has not yet been widely used.



*A. Raw image of *Caenorhabditis elegans* as obtained from the cryo-FIB, showing the poor SNR. B. Post-processed image making it possible readily discern cellular structures. Images courtesy of Anna Steyer EMBL, Germany.*

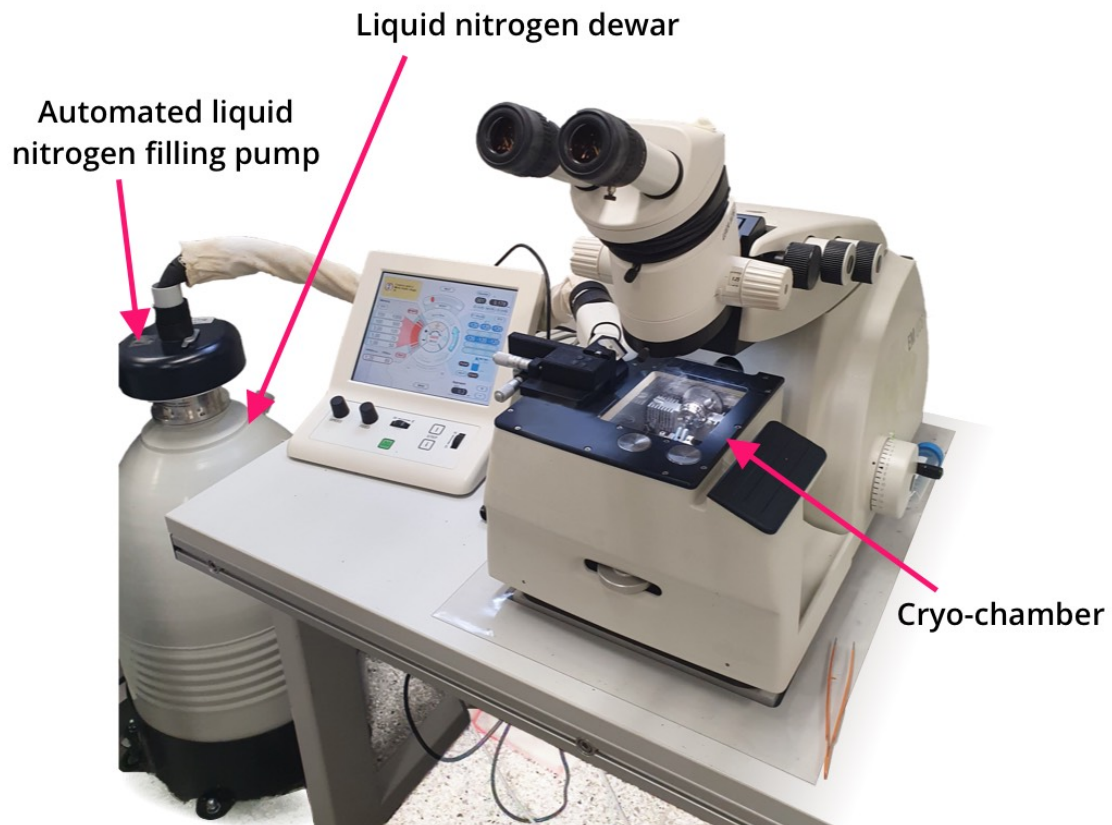


**A****B****C****D**

A-C. Three selected slices within an image stack of a HeLa cell. The images have been processed to remove artefacts and to denoise. D. 3D reconstruction of the cell showing segmentation of mitochondria (red), lipid bodies (yellow), lysosomes (orange), nuclear pores (blue spheres), nucleoli (transparent blue). Images courtesy of Daniele Spehner, Institut de Génétique et de Biologie Moléculaire et Cellulaire, France and Anna Steyer EMBL, Germany.

# Cryo-ultramicrotomy

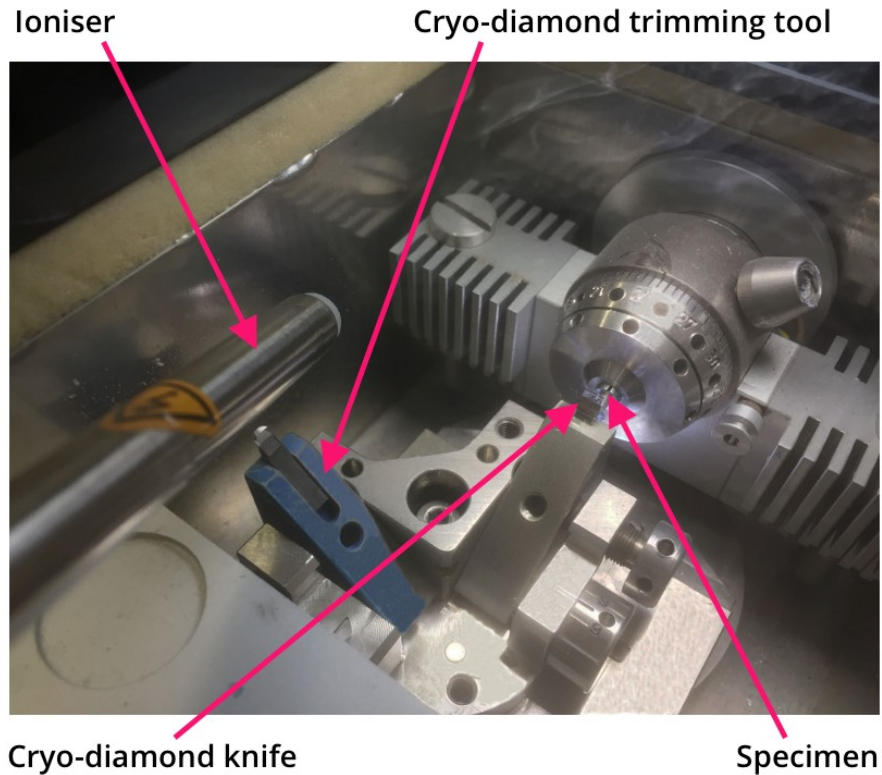
Cryo-ultramicrotomy involves cutting ultra-thin sections from a frozen sample. These are thin enough to be viewed in a cryo-TEM. A cryo-ultramicrotome maintains temperatures below  $-140^{\circ}\text{C}$  and can cut cryo-sections below 100nm in thickness. The technique has been called cryo-electron microscopy of vitreous sections or CEMOVIS.



*A cryo-ultramicrotome.*

Before freezing, samples are pelleted and resuspended in 20% dextran (MW 40kDa) to act as a cryoprotectant and to enhance the cutting properties. Samples are vitrified in a high pressure freezer and then moved to the cryo-ultramicrotome chamber.

The blockface needs to be small and is trimmed to 100-200 $\mu\text{m}$  on each side. The sections of 50nm or greater are manipulated with an eyelash attached to a stick to manoeuvre them over the copper grid.



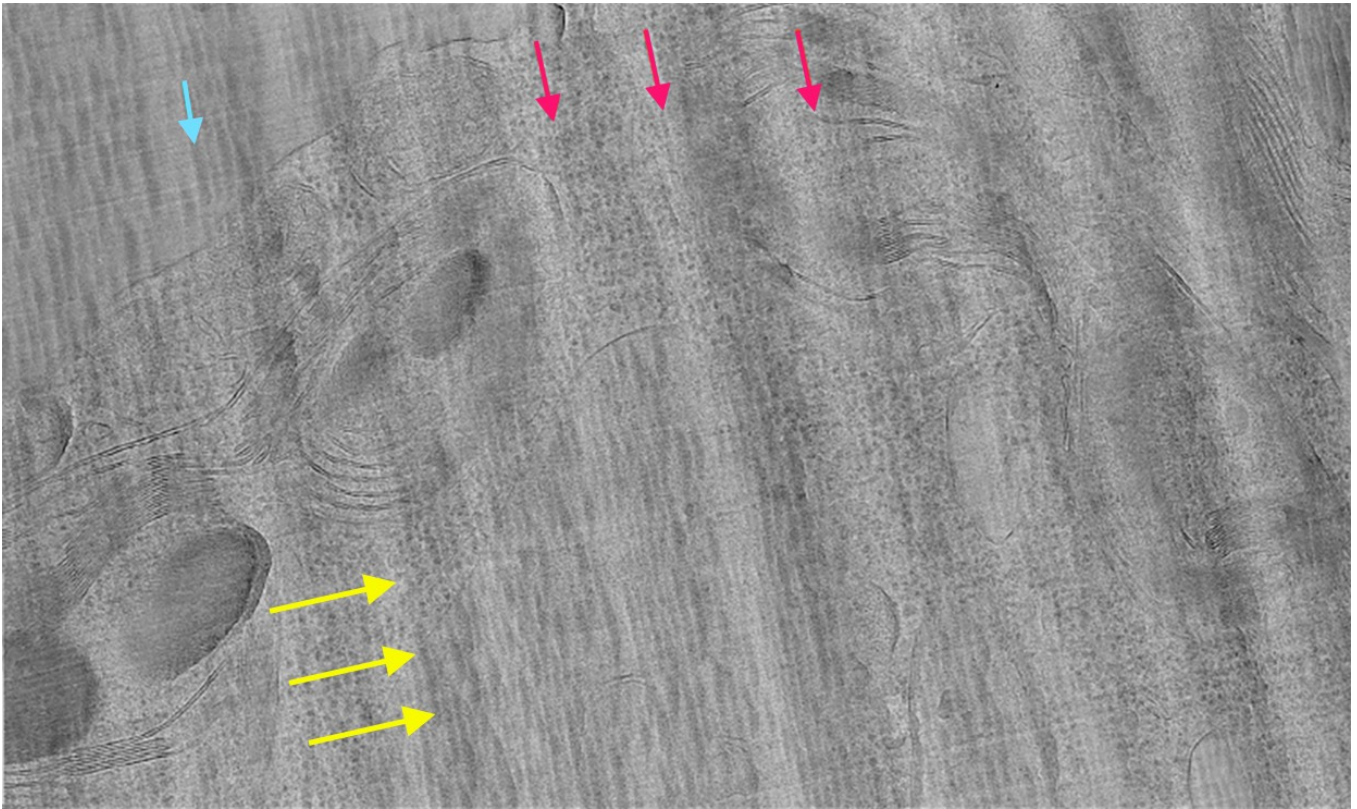
*Chamber of a cryo-ultramicrotome*

The sections are cut dry on a diamond knife. As the sections tend to bunch up on the knife surface and do not stick well to the copper grid, an ioniser in the chamber is used to alleviate both these issues. In discharge mode it facilitates smooth gliding of the ribbon of sections and in charge mode forces the sections to attach to the grid.

Unfortunately, the sections suffer from several artefacts:

- knife marks from contamination at the knife edge,
- chatter, which is periodic variations in the section thickness due to friction at the knife edge,
- crevasses, which are cracks or fractures in the sections caused by the shear stress
- compression causing thickening and shortening of the sections by between 30 and 60%.

The first three can be addressed to some degree by changes to the cutting speed, section thickness and knife angle. However, while these adjustments can reduce it, compression cannot be completely eliminated.



*Cryo-section of the alga Chlamydomonas reinhardtii showing knife marks (yellow arrows), crevasses (blue arrows) and chatter (red arrows). Image courtesy of Alasdair McDowall, Caltech.*

The technique has been used widely for studies of biological samples including for cryo-tomography. However, due to these artefacts and the development of the cryo-FIB for cutting lamella, cryo-ultramicrotomy has fallen out of favour.

It is however, still extensively used in immuno-labelling studies, the so-called Tokuyasu technique, but this involves sectioning of fixed and cryoprotected samples and the sections are thawed so they can be labelled and viewed at room temperature.

# Credits

---

Microscopy Australia acknowledges the huge input of time and expertise by the many staff members and associates who have contributed to the development of MyScope over the years.

For Cryo-Electron Microscopy we thank: Rick Webb, Nick Ariotti , Lou Brillault, Peta Clode, Gediminas Gervinskas, Michael Landsberg, Chris Lupton, Naphak Modhiran, Georg Ramm, Juanfang Ruan, Alasdair Stewart, Vikas Tillu, Hari Venugopal and Jenny Whiting.